

# Steel Sewer Products

## CHAPTER 1

---

### INTRODUCTION

Corrugated steel pipe (CSP) provides a strong, durable, economical selection for the construction of sewer systems. Introduced by a city engineer in 1896, countless miles of CSP now provide reliable service throughout the highway system, and in large and small municipalities across the North American continent.

The sewer designer can select from a wide range of CSP products to meet exacting job requirements. Factory-made pipe, in sizes large enough to accommodate most needs, is available with a variety of corrugation profiles that provide optimal strength. For larger structures, structural plate pipe can be furnished for bolted assembly in the field. Shop fabricated fittings, long lightweight sections, reliable and positive coupling systems—all contribute to speed and economy in field installation. In addition, a range of protective coatings is available to meet rigorous service demands.

### CORRUGATED STEEL PIPE AND STRUCTURAL PLATE PIPE DATA

#### Corrugated Steel Pipe

There are basically two types of corrugated steel pipe: helical and annular.

**Helical CSP**, where the corrugations and seams run helically around the pipe, is fabricated by:

- a) lockseam method,
- b) continuous welding of the seams,
- c) integrally attaching at the lockseam a helically corrugated steel sheet with a smooth inner steel lining (smooth lined pipe).

Reformed annular ends for joining are available.

**Annular CSP**, where the corrugations run annularly around the pipe, is fabricated by:

- a) riveting the seams,
- b) bolting the seams,
- c) resistance spot welding the seams.

A wide variety of geometrical shapes are available in corrugated steel pipe to satisfy requirements such as low headroom or greater hydraulic efficiency.

Table 1.1 illustrates the sizes, corrugation profiles, steel thickness and shapes available for the various types of steel pipe.

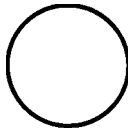
Handling weights for CSP are shown in Tables 1.2, 1.3, 1.4, 1.5 and 1.6. Tables 1.7 and 1.8 show the design details for corrugated steel pipe-arches.

#### Structural Plate Pipe

For larger structures requiring field assembly, structural plate pipe is available. Structural plate pipe is fabricated from hot-dip galvanized plates and is assembled by bolting individual plates together to form large pipes, pipe-arches and a variety of other shapes.

Standard sizes of structural plate are indicated in Table 1.1.

Sizes and layout details for circular pipe, pipe-arches and arches are illustrated in Tables 1.9, 1.10 and 1.11.



Round

Pipe Arch



**Table 1.1** Sizes, Corrugation Profiles, Thickness and Shapes Available for Various Types of Steel Pipe

Type of Pipe	Size (Diameter or Span)		Corrugation Profile		Specified Thickness Range		Shape
	(mm)	(in.)	(mm)	(in.)	(mm)	(in.)	
Corrugated Steel Pipe (Helical and Annular Pipe)	150 - 450	6 - 18	38 x 6.5	1½ x ¼	1.32 - 1.63	.052 - 0.064	Round
	150 - 900	6 - 36	51 x 13	2 x ½	1.32 - 2.01	.052 - .079	Round
	300 - 2400	12 - 96	68 x 13	2⅔ x ½	1.32 - 4.27	.052 - 0.168	Round, Pipe-Arch
	1350 - 3600	54 - 144	75 x 25	3 x 1	1.63 - 4.27	.064 - 0.168	Round
	1350 - 3600	54 - 144	125 x 25*	5 x 1	1.63 - 4.27	.064 - 0.168	Round
	1350 - 3600	54 - 120	75 x 25	3 x 1	2.01 - 4.27	.079 - 0.168	Pipe-arch
1800 - 3000	72 - 120	125 x 25*	5 x 1	2.77 - 4.27	.109 - 0.168	Pipe-arch	
Spiral Rib Pipe	450 - 2400	18 - 96	19x19x190	¾ x ¾ x 7½	1.63 - 2.77	.064 - 0.109	Round, Pipe-Arch
	900 - 2850	36 - 114	19x25x292	¾ x 1 x 11½	1.63 - 2.77	.004 - 0.109	Round, Pipe-Arch
Structural Plate Pipe	1500 - 8010	5 ft - 26 ft	152 x 51	6 x 2	2.82 - 9.65	0.109 - 0.280	Round, Pipe-Arch Elliptical & Other Special Shapes

**Notes:** \*Available only in helical pipe.

**Table 1.2** Corrugated Steel Pipe (CSP) — Round Standard Diameters, End Areas, and Handling Weights 38 mm x 6.5 mm (1½ x ¼ in.) Estimated Average Weights — Not for Specification Use

Inside Diameter		End Area		Approximate Kilograms per Linear Meter (Pounds Per Linear Foot) (Weights will vary slightly with fabrication method)					
				Specified Thickness		Metallic Coated*		Full Bituminous Coated	
(mm)	(in.)	(m²)	(ft²)	(mm)	(in.)	(mm)	(in.)	(mm)	(in.)
150	6	0.018	0.196	1.32	.052	5.8	3.9	7.3	4.9
				1.63	.064	7.1	4.0	8.8	5.9
200	8	0.031	0.349	1.32	.052	7.7	5.2	9.7	6.5
				1.63	.064	9.4	6.3	11.3	7.6
250	10	0.049	0.545	1.32	.052	9.7	6.5	12.0	8.1
				1.63	.064	11.5	7.7	13.8	9.3
300	12	0.071	0.785	1.32	.052	11.3	7.6	14.3	9.6
				1.63	.064	14.0	9.4	17.0	11.4
375	15	0.110	1.227	1.32	.052	14.1	9.5	17.7	11.9
				1.63	.064	17.4	11.7	21.0	14.1
450	18	0.159	1.767	1.32	.052	17.0	11.4	21.3	14.3
				1.63	.064	20.8	14.0	25.1	16.9

**Notes:** Perforated sub-drains will weigh slightly less.

\*Metallic coated: Galvanized or Aluminized

**Table 1.3M Handling Weight of Corrugated Steel Pipe (68 mm x 13 mm)  
Estimated Average Weights - Not for Specification Use\***

Inside Diameter (mm)	End Area (m <sup>2</sup> )	Specified Thickness (mm)	Approximate Kilograms Per Linear Meter**					
			Metallic Coated	Full Bituminous Coated	Full Bituminous Coated and Invert Paved	Bituminous Coated and Full Paved	Steel Lined	Concrete Lined
300	0.07	1.32	12	15	19			
		1.63	15	18	22			
		2.01	18	21	25			
375	0.11	1.32	15	18	22	39		
		1.63	18	22	27	42		
		2.01	22	27	31	46		
450	0.16	1.32	18	21	25	46		
		1.63	22	28	33	51	25	
		2.01	27	33	37	55	30	
525	0.22	1.32	21	24	28	54		
		1.63	25	31	39	61	31	
		2.01	31	37	45	64	36	
600	0.28	1.32	22	25	30	61		
		1.63	28	36	45	67	34	97
		2.01	36	43	52	74	39	103
750	0.44	1.32	30	33	37	76		
		1.63	36	45	54	82	43	122
		2.01	45	54	63	89	51	129
900	0.64	1.32	36	39	43	74		
		1.63	43	54	65	97	52	146
		2.01	54	64	76	112	61	155
		2.77	74	34	96	135		174
		3.51	93	104	115	150		190
1050	0.87	1.32	42	45	49	106		
		1.63	51	63	76	115	63	170
		2.01	63	74	88	126	71	180
		2.77	85	97	111	157		202
		3.51	108	120	133	172		223
1200	1.13	1.32	46	49	54			
		1.63	57	71	85	126	68	190
		2.01	71	86	100	141	79	205
		2.77	97	112	126	180		231
		3.51	123	138	151	195		255
		4.27	150	165	178	232		279
1350	1.43	1.63	65	82	98	141	77	
		2.01	80	97	113	156	88	232
		2.77	109	126	142	195		259
		3.51	138	154	171	232		286
		4.27	168	184	201	262		313
1500	1.77	2.01	89	106	126		101	
		2.77	121	137	158	208	131	286
		3.51	154	171	192	270		318
		4.27	186	202	223	285		348

**Notes:** Pipe-arch weights will be the same as the equivalent round pipe. For example, for 1060 mm x 740 mm, 68 mm x 13 mm pipe-arch, refer to 900 mm diameter pipe weight.

\* Lock seam construction only; weights will vary with other fabrication practices.

\*\* For other coatings or linings, the weights may be interpolated.

**Table 1.3M Handling Weight of Corrugated Steel Pipe (68 mm x 13 mm)  
(Cont.) Estimated Average Weights - Not for Specification Use\***

Inside Diameter (mm)	End Area (m <sup>2</sup> )	Specified Thickness (mm)	Approximate Kilograms Per Linear Meter**					
			Metallic Coated	Full Bituminous Coated	Full Bituminous Coated and Invert Paved	Bituminous Coated and Full Paved	Steel Lined	Concrete Lined
1650	2.14	2.01	97	115	139			
		2.77	132	150	174	238	143	314
		3.51	168	186	210	267	179	347
		4.27	205	223	247	205		382
1800	2.54	2.77	146	167	192	253	156	
		3.51	183	204	229	313	196	378
		4.27	223	244	270	354		417
1950	2.99	2.77	156	180	205	298	168	
		3.51	198	222	247	342	211	
		4.27	241	265	291	390		453
2100	3.46	2.77	168	198	231	335	180	
		3.51	214	240	266	357	226	
		4.27	259	285	312	405		487
2250	3.98	2.77	181	217	250		195	
		3.51	229	256	286		243	
		4.27	277	304	333	430	292	518
2400	4.52	3.51	244	284	323		259	
		4.27	295	323	339	460	310	552

**Notes:** Pipe-arch weights will be the same as the equivalent round pipe. For example, for 1060 mm x 740 mm, 68 mm x 13 mm pipe-arch, refer to 900 mm diameter pipe weight.

\*Lock seam construction only; weights will vary with other fabrication practices.

\*\* For other coatings or linings, the weights may be interpolated.

**Table 1.3 Handling Weight of Corrugated Steel Pipe (2<sup>2</sup>/<sub>3</sub> x 1/2 in.)  
Estimated Average Weights - Not for Specification Use\***

Inside Diameter (in.)	End Area (ft <sup>2</sup> )	Specified Thickness (in.)	Approximate Kilograms Per Linear Meter**					
			Metallic Coated	Full Bituminous Coated	Full Bituminous Coated and Invert Paved	Bituminous Coated and Full Paved	Steel Lined	Concrete Lined
12	0.79	0.052	8	10	13			
		0.064	10	12	15			
		0.079	12	14	17			
15	1.23	0.052	10	12	15	26		
		0.064	12	15	18	28		
		0.079	15	18	21	31		
18	1.77	0.052	12	14	17	31		
		0.064	15	19	22	34	17	
		0.079	18	22	25	37	20	
21	2.41	0.052	14	16	19	36		
		0.064	17	21	26	39	21	
		0.079	21	25	30	43	24	
24	3.14	0.052	15	17	20	41		
		0.064	19	24	30	45	23	65
		0.079	24	29	35	50	26	69
30	4.91	0.052	20	22	25	51		
		0.064	24	30	36	55	29	82
		0.079	30	36	42	60	34	87
36	7.07	0.052	24	26	29	50		
		0.064	29	36	44	65	35	98
		0.079	36	43	51	75	41	104
		0.109	49	56	64	90		116
		0.138	62	69	77	100		127
42	9.62	0.052	28	30	33	71		
		0.064	34	42	51	77	42	114
		0.079	42	50	59	85	48	121
		0.109	57	65	74	105		135
		0.138	72	80	89	115		149
48	12.57	0.052	31	33	36			
		0.064	38	48	57	85	46	128
		0.079	48	58	67	95	53	138
		0.109	65	75	84	120		154
		0.138	82	92	101	130		170
		0.168	100	110	119	155		186
54	15.90	0.064	44	55	66	95	52	
		0.079	54	65	76	105	59	156
		0.109	73	84	95	130		173
		0.138	92	103	114	155		191
		0.168	112	123	134	175		209

**Notes:** Pipe-arch weights will be the same as the equivalent round pipe.  
 For example, for 42 x 29, 2<sup>2</sup>/<sub>3</sub> x 1/2 pipe-arch, refer to 36 in. diameter pipe weight.  
 \* Lock seam construction only; weights will vary with other fabrication practices.  
 \*\* For other coatings or linings, the weights may be interpolated.

**Table 1.3 Handling Weight of Corrugated Steel Pipe (2<sup>2</sup>/<sub>3</sub> x 1/2 in.)  
(Cont.) Estimated Average Weights — Not for Specification Use\***

Inside Diameter (in.)	End Area (ft <sup>2</sup> )	Specified Thickness (in.)	Approximate Kilograms Per Linear Meter**					
			Metallic Coated	Full Bituminous Coated	Full Bituminous Coated and Invert Paved	Bituminous Coated and Full Paved	Steel Lined	Concrete Lined
60	19.64	0.079	60	71	85		68	
		0.109	81	92	106	140	88	192
		0.138	103	114	128	180		212
		0.168	124	135	149	190		232
66	23.76	0.079	65	77	93			
		0.109	89	101	117	160	96	211
		0.138	113	125	141	180	120	233
		0.168	137	149	165	210		255
72	28.27	0.109	98	112	129	170	105	
		0.138	123	137	154	210	132	254
		0.168	149	163	180	236		278
78	33.18	0.109	105	121	138	200	113	
		0.138	133	149	166	230	142	
		0.168	161	177	194	260		302
84	38.49	0.109	113	133	155	225	121	
		0.138	144	161	179	240	152	
		0.168	173	190	208	270		325
90	44.18	0.109	121	145	167		130	
		0.138	154	172	192		163	
		0.168	186	204	224	289	196	348
96	50.27	0.138	164	191	217		174	
		0.168	198	217	239	309	208	371

- Notes:** Pipe-arch weights will be the same as the equivalent round pipe.  
For example, for 42 x 29, 2<sup>2</sup>/<sub>3</sub> x 1/2 pipe-arch, refer to 36 in. diameter pipe weight.  
\* Lock seam construction only; weights will vary with other fabrication practices.  
\*\* For other coatings or linings, the weights may be interpolated.

**Table 1.4M Handling Weight of Corrugated Steel Pipe  
(75 mm x 25 mm or 125 mm x 25 mm\*)  
Estimated Average Weights — Not for Specification Use\*\***

Inside Diameter	End Area	Specified Thickness	Approximate Kilograms Per Linear Meter***					
			Metallic Coated	Full Bituminous Coated	Full Bituminous Coated and Invert Paved	Bituminous Coated and Full Paved	Steel Lined	Concrete Lined
(mm)	(m <sup>2</sup> )	(mm)						
1350	1.43	1.63	74	98	125	205	86	293
		2.01	91	115	141	222	100	308
		2.77	124	150	177	256		339
		3.51	159	184	210	291		367
		4.27	193	219	244	325		396
1500	1.77	1.63	82	109	138	228	95	324
		2.01	100	128	156	246	110	341
		2.77	138	165	195	285		367
		3.51	177	204	234	324		408
		4.27	214	241	271	361		439
1650	2.14	1.63	89	119	152	250	104	357
		2.01	110	140	173	269	121	375
		2.77	151	181	214	312		414
		3.51	193	223	256	354		448
		4.27	235	265	298	396		483
1800	2.54	1.63	98	131	165	272	115	390
		2.01	121	152	188	293	132	409
		2.77	165	198	234	340		451
		3.51	210	243	279	385		489
		4.27	256	289	325	432		526
2100	3.46	1.63	115	152	193	317	132	
		2.01	140	177	219	342	155	478
		2.77	192	231	273	396		526
		3.51	246	285	325	450		568
		4.27	298	336	379	502		613
2250	3.98	1.63	115	152	193	317	132	
		2.01	149	189	235	366	165	
		2.77	205	246	292	424	216	564
		3.51	262	303	349	481		609
		4.27	319	360	406	538		657
2400	4.52	1.63	129	173	222	360	152	
		2.01	159	202	251	390	176	
		2.77	20	264	313	453	231	601
		3.51	28	325	375	514		649
		4.27	342	385	435	574		760

**Notes:** Pipe-arch weights will be the same as the equivalent round pipe. For example, for 2050 mm x 1500 mm, 76 mm x 25 mm pipe-arch, refer to 1800 mm diameter pipe weight  
 \* 125 mm x 25 mm weighs approximately 12% less than 75 mm x 25 mm  
 \*\* Lock seam construction only; weights will vary with other fabrication practices.  
 \*\*\* For other coatings or linings, the weights may be interpolated.

**Table 1.4M Handling Weight of Corrugated Steel Pipe  
(75 mm x 25 mm or 125 mm x 25 mm\*)  
(Cont.) Estimated Average Weights — Not for Specification Use\*\***

Inside Diameter	End Area	Specified Thickness	Approximate Kilograms Per Linear Meter***					Concrete Lined
			Metallic Coated	Full Bituminous Coated	Full Bituminous Coated and Invert Paved	Bituminous Coated and Full Paved	Steel Lined	
(mm)	(m <sup>2</sup> )	(mm)						
2550	5.11	1.63	138	185	235	384	161	639
		2.01	170	216	266	415	188	
		2.77	232	283	330	480	246	
		3.51	297	343	394	554	690	
		4.27	361	408	459	609	744	
2700	5.73	1.63	155	207	262	430	180	730
		2.01	179	228	280	439	198	
		2.77	247	297	349	510	259	
		3.51	316	366	418	579	787	
		4.27	384	433	486	646		
2850	6.38	1.63	155	207	262	430	180	771
		2.01	199	254	313	490	220	
		2.77	272	327	385	563	287	
		3.51	333	385	441	610	874	
		4.27	426	481	540	718		
3000	7.07	1.63	163	219	274	444	190	811
		2.01	201	256	315	483	222	
		2.77	274	330	388	567	289	
		3.51	351	406	465	643	874	
		4.27	426	481	540	718		
3150	7.79	2.01	210	266	327	515	231	302
		2.77	290	347	408	595		
		3.51	370	427	489	678		
3300	8.55	2.01	220	280	344	540	243	317
		2.77	304	363	427	624		
		3.51	388	448	513	711		
		4.27	471	531	595	793		
3450	9.35	2.01	229	292	359	564	251	329
		2.77	317	379	446	652		
		3.51	405	468	535	742		
		4.27	492	555	622	829		
3600	10.18	2.77	332	397	467	682	345	436
		3.51	420	485	555	769		
		4.27	516	582	652	868		

**Notes:** Pipe-arch weights will be the same as the equivalent round pipe. For example, for 2050 mm x 1500 mm, 75 mm x 25 mm pipe-arch, refer to 1800 mm diameter pipe weight.

\* 125 mm x 25 mm weighs approximately 12% less than 75 mm x 25 mm

\*\* Lock seam construction only; weights will vary with other fabrication practices.

\*\*\* For other coatings or linings, the weights may be interpolated.



**Table 1.4 Handling Weight of Corrugated Steel Pipe (3 x 1 in. or 5 x 1in.\*)  
Estimated Average Weights — Not for Specification Use\*\***

Inside Diameter	End Area	Specified Thickness	Approximate Pounds Per Linear Foot***					
			Metallic Coated	Full Bituminous Coated	Full Bituminous Coated and Invert Paved	Bituminous Coated and Full Paved	Steel Lined	Concrete Lined
(in.)	(ft²)	(in.)						
54	15.9	0.064	50	66	84	138	58	197
		0.079	61	77	95	67	207	
		0.109	83	100	118	171	226	
		0.138	106	123	140	194	245	
		0.168	129	146	163	217	264	
60	19.6	0.064	55	73	93	153	64	218
		0.079	67	86	105	74	229	
		0.109	92	110	130	190	251	
		0.138	118	136	156	216	272	
		0.168	143	161	181	241	293	
66	23.8	0.064	60	80	102	168	70	240
		0.079	74	94	116	81	252	
		0.109	101	121	143	208	276	
		0.138	129	149	171	236	299	
		0.168	157	177	199	264	322	
72	28.3	0.064	66	88	111	183	77	262
		0.079	81	102	126	197	89	275
		0.109	110	132	156	227	301	
		0.138	140	162	186	257	326	
		0.168	171	193	217	288	351	
84	38.5	0.064	77	102	130	213	89	321
		0.079	94	119	147	230	104	321
		0.109	128	154	182	264	351	
		0.138	164	189	217	300	379	
		0.168	199	224	253	335	409	
90	44.2	0.064	82	109	140	228	96	376
		0.079	100	127	158	246	111	406
		0.109	137	164	195	283	144	438
		0.138	175	202	233	321		
		0.168	213	240	271	359		
96	50.3	0.064	87	116	149	242	102	401
		0.079	107	136	169	262	118	433
		0.109	147	176	209	302	154	467
		0.138	188	217	250	343		
		0.168	228	257	290	383		

**Notes:** Pipe-arch weights will be the same as the equivalent round pipe. For example: for 81 x 59, 3 x 1 in. pipe-arch, refer to 72 in. diameter pipe weight.

\*5 x 1 in. weighs approximately 12% less than 3 x 1 in.

\*\*Lock seam construction only, weights will vary with other fabrication practices.

\*\*\*For other coatings or linings the weights may be interpolated.

**Table 1.4 Handling Weight of Corrugated Steel Pipe (3 x 1 in. or 5 x 1 in.\*)  
(Cont.) Estimated Average Weights — Not for Specification Use\*\***

Inside Diameter	End Area	Specified Thickness	Approximate Pounds Per Linear Foot***					Steel Lined	Concrete Lined
			Metallic Coated	Full Bituminous Coated	Full Bituminous Coated and Invert Paved	Bituminous Coated and Full Paved			
(in.)	(ft <sup>2</sup> )	(in.)							
102	56.8	0.064	93	124	158	258	108	426 460 496	
		0.079	114	145	179	279	126		
		0.109	155	189	220	320	164		
		0.138	198	229	263	363			
		0.168	241	272	306	406			
108	63.6	0.064	98	131	166	273	115	487 525	
		0.079	120	153	188	295	133		
		0.109	165	198	233	340	173		
		0.138	211	244	279	386			
		0.168	256	289	324	431			
114	70.9	0.064	104	139	176	289	121	514 583	
		0.079	127	162	199	312	141		
		0.109	174	209	246	359	183		
		0.138	222	257	294	407			
		0.168	284	321	360	479			
120	78.5	0.064	109	146	183	296	127	541 583	
		0.079	134	171	210	329	148		
		0.109	183	220	259	378	193		
		0.138	234	271	310	429			
		0.168	284	321	360	479			
126	86.6	0.079	141	179	220	346	155		
		0.109	195	233	274	400	203		
		0.138	247	285	326	452			
132	95.0	0.079	148	188	231	363	163		
		0.109	204	244	287	419	213		
		0.138	259	299	342	474			
		0.168	314	354	397	529			
138	103.9	0.079	154	196	241	379	169		
		0.109	213	255	300	438	221		
		0.138	270	312	357	495			
		0.168	328	370	415	553			
144	113.1	0.109	223	267	314	458	232		
		0.138	282	326	373	517	293		
		0.168	344	388	435	579			

**Notes:** Pipe-arch weights will be the same as the equivalent round pipe. For example: for 81 x 59, 3 x 1 in. pipe-arch, refer to 72 in. diameter pipe weight.

\*5 x 1 in. weighs approximately 12% less than 3 x 1 in.

\*\*Lock seam construction only, weights will vary with other fabrication practices.

\*\*\*For other coatings or linings the weights may be interpolated.

**Table 1.5 End Areas and Handling Weights of Spiral Rib Pipe  
19 mm x 19 mm rib at 190 mm (3/4 x 3/4 x 7 1/2 in.) and  
19 mm x 25 mm Rib at 292 mm (3/4 x 1 x 11 1/2 in.)  
Estimated Average Weights — Not for Specification Use\***

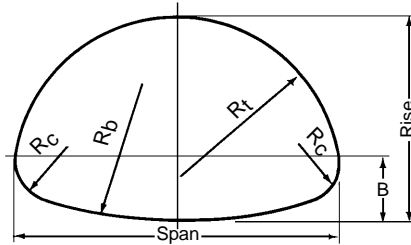
Inside Diameter		End Area		Specified Thickness		Approximate Kilograms Per Linear Meter** (Pounds Per Linear Foot)					
						Metallic Coated		Full Bituminous Coated		Full Bituminous Coated and Invert Paved	
(mm)	(in.)	(m <sup>2</sup> )	(ft <sup>2</sup> )	(mm)	(in.)	(kg/m)	(lbs/ft)	(kg/m)	(lbs/ft)	(kg/m)	(lbs/ft)
450	18	0.16	1.8	1.63	.064	22	15	28	19	30	20
				2.01	.079	27	18	33	22	34	23
525	21	0.22	2.4	1.63	.064	25	17	31	21	33	22
				2.01	.079	31	21	37	25	39	26
				2.77	.109	43	29	49	33	49	33
600	24	0.28	3.1	1.63	.064	30	19	37	24	39	25
				2.01	.079	36	24	43	29	44	32
				2.77	.109	54	36	61	41	63	42
750	30	0.44	4.9	1.63	.064	37	24	46	30	49	32
				2.01	.079	46	30	55	36	58	38
				2.77	.109	63	42	71	48	74	50
900	36	0.64	7.1	1.63	.064	45	29	55	36	58	38
				2.01	.079	55	36	65	43	68	45
				2.77	.109	74	50	85	57	88	59
1050	42	0.87	9.6	1.63	.064	52	33	64	41	67	43
				2.01	.079	64	42	76	50	79	52
				2.77	.109	86	58	98	66	90	60
1200	48	1.13	12.6	1.63	.064	60	38	74	48	77	50
				2.01	.079	73	48	88	58	91	60
				2.77	.109	100	66	115	76	118	78
1350	54	1.43	15.9	1.63	.064	67	43	83	54	86	56
				2.01	.079	82	54	98	65	101	67
				2.77	.109	112	75	128	86	131	88
1500	60	1.77	19.6	1.63	.064	74	48	92	60	95	62
				2.01	.079	91	60	109	72	112	74
				2.77	.109	124	83	141	95	144	97
1650	66	2.14	23.8	1.63***	.064	79	53	99	66	102	68
				2.01	.079	99	66	118	79	121	81
				2.77	.109	136	91	156	104	159	106
1800	72	2.54	28.1	2.01	.079	109	72	129	86	134	89
				2.77	.109	149	99	170	113	174	116
1950	78	2.99	33.2	2.01	.079	118	78	140	93	144	96
				2.77	.109	161	108	171	115	176	118
2100	84	3.46	38.5	2.01***	.079	106	71	131	101	135	104
				2.77	.109	173	116	198	133	202	136
2250	90	3.98	44.2	2.77	.109	186	124	214	143	220	147
2400	96	4.52	50.3	2.77	.109	198	132	228	152	234	156
2550	102	5.11	56.8	2.77	.109	210	141	243	163	249	167
2700	108	5.73	63.6	2.77***	.109	223	150	256	172	262	176

**Notes:** \* Lock seam construction only.  
 \*\* For other coatings or linings, the weights may be interpolated.  
 \*\*\* For 19 mm x 25 mm rib at 292 mm (3/4 x 1 x 11 1/2 in.) only.

## Perforated Pipe

Corrugated steel pipe is available with perforations for collection or dissemination of water underground. Most fabricators are equipped to furnish 10 mm ( $\frac{3}{8}$  in.) round holes. Other sizes and configurations are available.

The most common standard pattern is 320 - 10 mm ( $30 - \frac{3}{8}$  in. per square foot) round holes per square meter of pipe surface. See Chapter 6 for design requirements.



**Table 1.6M** Sizes and Layout Details — CSP Pipe-Arches  
(68 mm x 13 mm Corrugation)

Equiv. Diameter	Design		Waterway Area	Layout Dimensions			
	Span	Rise		B	Rc	Rt	Rb
(mm)	(mm)	(mm)	(m <sup>2</sup> )	(mm)	(mm)	(mm)	(mm)
375	430	330	0.10	105	90	220	650
450	530	380	0.15	125	105	275	840
525	610	460	0.20	145	125	300	880
600	710	510	0.27	165	140	355	1075
750	885	610	0.42	205	175	455	1400
900	1060	740	0.60	250	210	545	1680
1050	1240	840	0.83	290	245	640	1960
1200	1440	970	1.08	330	280	725	2240
1350	1620	1100	1.37	370	315	820	2520
1500	1800	1200	1.68	415	350	910	2800
1650	1950	1320	2.03	455	385	1000	3080
1800	2100	1450	2.42	495	420	1090	3360

**Notes:** Dimensions shown are not for specification purposes, subject to manufacturing tolerances.

**Table 1.6** Sizes and Layout Details — CSP Pipe-Arches  
(2 $\frac{1}{8}$  x  $\frac{1}{2}$  in. Corrugation)

Equiv. Diameter	Design		Waterway Area	Layout Dimensions			
	Span	Rise		B	Rc	Rt	Rb
(in.)	(in.)	(in.)	(ft <sup>2</sup> )	(in.)	(in.)	(in.)	(in.)
15	17	13	1.1	4 $\frac{1}{8}$	3 $\frac{1}{2}$	8 $\frac{5}{8}$	25 $\frac{5}{8}$
18	21	15	1.6	4 $\frac{1}{8}$	4 $\frac{1}{8}$	10 $\frac{1}{4}$	33 $\frac{3}{8}$
21	24	18	2.2	5 $\frac{5}{8}$	4 $\frac{7}{8}$	11 $\frac{1}{8}$	34 $\frac{5}{8}$
24	28	20	2.9	6 $\frac{1}{2}$	5 $\frac{1}{2}$	14	42 $\frac{1}{4}$
30	35	24	4.5	8 $\frac{1}{8}$	6 $\frac{7}{8}$	17 $\frac{1}{8}$	55 $\frac{1}{8}$
36	42	29	6.5	9 $\frac{3}{4}$	8 $\frac{1}{4}$	21 $\frac{1}{2}$	66 $\frac{1}{8}$
42	49	33	8.9	11 $\frac{3}{8}$	9 $\frac{5}{8}$	25 $\frac{1}{8}$	77 $\frac{1}{4}$
48	57	38	11.6	13	11	28 $\frac{5}{8}$	88 $\frac{1}{4}$
54	64	43	14.7	14 $\frac{7}{8}$	12 $\frac{7}{8}$	32 $\frac{1}{4}$	99 $\frac{1}{4}$
60	71	47	18.1	16 $\frac{1}{4}$	13 $\frac{3}{4}$	35 $\frac{3}{4}$	110 $\frac{1}{4}$
66	77	52	21.9	17 $\frac{7}{8}$	15 $\frac{1}{8}$	39 $\frac{3}{8}$	121 $\frac{1}{4}$
72	83	57	26.0	19 $\frac{1}{2}$	16 $\frac{1}{2}$	43	132 $\frac{1}{4}$

**Notes:** Dimensions shown are not for specification purposes, subject to manufacturing tolerances.

**Table 1.7M Sizes and Layout Details — CSP Pipe-Arches  
(125 mm x 25 mm and 76 mm x 25 mm Corrugation)**

Equiv. Diameter	Nominal Size	Design		Waterway Area	Layout Dimensions			
		Span	Rise		B	Rc	Rt	Rb
(mm)	(mm)	(m <sup>2</sup> )	(mm)	(m <sup>2</sup> )	(mm)	(mm)	(mm)	(mm)
1200	1340 x 1050	1340	1050	1.09	385	260	715	1865
1350	1520 x 1170	1485	1235	1.45	520	475	745	1300
1500	1670 x 1300	1650	1375	1.79	580	525	830	1430
1650	1850 x 1400	1840	1480	2.16	640	580	935	1620
1800	2050 x 1500	2005	1585	2.56	605	530	1005	2100
1950	2200 x 1620	2195	1710	2.98	655	575	1100	2345
2100	2400 x 1720	2370	1825	3.44	705	620	1195	2545
2250	2600 x 1820	2575	1935	3.94	755	665	1300	2835
2400	2840 x 1920	2755	2045	4.46	805	705	1395	3055
2550	2970 x 2020	2955	2155	5.04	855	750	1510	3345
2700	3240 x 2100	3135	2270	5.62	905	795	1605	3550
2850	3470 x 2220	3325	2385	6.26	955	840	1710	3795
3000	3600 x 2320	3515	2490	6.92	1005	885	1820	4125
3150	3800 x 2440	3705	2595	7.52	1040	915	1930	4370
3300	3980 x 2570	3885	2720	8.27	1090	965	2030	4570
3450	4160 x 2670	4035	2875	9.10	1145	1015	2085	4675
3600	4340 x 2790	4190	3010	9.94	1195	1040	2160	4825

**Notes:** Dimensions shown are not for specification purposes, subject to manufacturing tolerances.

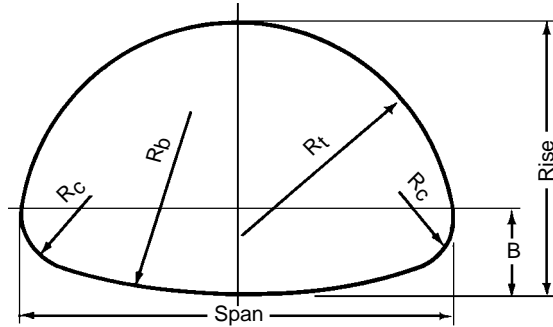
**Table 1.7 Sizes and Layout Details — CSP Pipe-Arches  
(3 x 1 or 5 x 1 in. Corrugation)**

Equiv. Diameter	Nominal Size	Design		Waterway Area	Layout Dimensions			
		Span	Rise		B	Rc	Rt	Rb
(in.)	(in.)	(in.)	(in.)	(ft <sup>2</sup> )	(in.)	(in.)	(in.)	(in.)
48	53 x 41	53	41	11.7	15 <sup>1</sup> / <sub>4</sub>	10 <sup>3</sup> / <sub>16</sub>	28 <sup>7</sup> / <sub>16</sub>	73 <sup>1</sup> / <sub>16</sub>
54	60 x 46	58 <sup>1</sup> / <sub>2</sub>	48 <sup>1</sup> / <sub>2</sub>	15.6	20 <sup>1</sup> / <sub>2</sub>	18 <sup>7</sup> / <sub>4</sub>	29 <sup>7</sup> / <sub>8</sub>	51 <sup>1</sup> / <sub>8</sub>
60	66 x 51	65	54	19.3	22 <sup>3</sup> / <sub>4</sub>	20 <sup>3</sup> / <sub>4</sub>	32 <sup>3</sup> / <sub>8</sub>	56 <sup>1</sup> / <sub>4</sub>
66	73 x 55	72 <sup>1</sup> / <sub>2</sub>	58 <sup>1</sup> / <sub>4</sub>	23.2	25 <sup>1</sup> / <sub>8</sub>	22 <sup>1</sup> / <sub>8</sub>	36 <sup>3</sup> / <sub>4</sub>	63 <sup>3</sup> / <sub>4</sub>
72	81 x 59	79	62 <sup>1</sup> / <sub>2</sub>	27.4	23 <sup>3</sup> / <sub>4</sub>	20 <sup>7</sup> / <sub>8</sub>	39 <sup>1</sup> / <sub>2</sub>	82 <sup>3</sup> / <sub>8</sub>
78	87 x 63	86 <sup>1</sup> / <sub>2</sub>	67 <sup>1</sup> / <sub>4</sub>	32.1	25 <sup>3</sup> / <sub>4</sub>	22 <sup>3</sup> / <sub>8</sub>	43 <sup>3</sup> / <sub>8</sub>	92 <sup>1</sup> / <sub>4</sub>
84	95 x 67	93 <sup>1</sup> / <sub>2</sub>	71 <sup>3</sup> / <sub>4</sub>	37.0	27 <sup>3</sup> / <sub>4</sub>	24 <sup>3</sup> / <sub>8</sub>	47	100 <sup>1</sup> / <sub>4</sub>
90	103 x 71	101 <sup>1</sup> / <sub>2</sub>	76	42.4	29 <sup>3</sup> / <sub>4</sub>	26 <sup>1</sup> / <sub>8</sub>	51 <sup>1</sup> / <sub>4</sub>	111 <sup>1</sup> / <sub>8</sub>
96	112 x 75	108 <sup>1</sup> / <sub>2</sub>	80 <sup>1</sup> / <sub>2</sub>	48.0	31 <sup>3</sup> / <sub>8</sub>	27 <sup>3</sup> / <sub>4</sub>	54 <sup>7</sup> / <sub>8</sub>	120 <sup>1</sup> / <sub>4</sub>
102	117 x 79	116 <sup>1</sup> / <sub>2</sub>	84 <sup>3</sup> / <sub>4</sub>	54.2	33 <sup>3</sup> / <sub>8</sub>	29 <sup>1</sup> / <sub>2</sub>	59 <sup>3</sup> / <sub>8</sub>	131 <sup>1</sup> / <sub>4</sub>
108	128 x 83	123 <sup>1</sup> / <sub>2</sub>	89 <sup>1</sup> / <sub>4</sub>	60.5	35 <sup>3</sup> / <sub>8</sub>	31 <sup>1</sup> / <sub>4</sub>	63 <sup>3</sup> / <sub>4</sub>	139 <sup>3</sup> / <sub>4</sub>
114	137 x 87	131	93 <sup>3</sup> / <sub>4</sub>	67.4	37 <sup>3</sup> / <sub>8</sub>	33	67 <sup>3</sup> / <sub>8</sub>	149 <sup>1</sup> / <sub>2</sub>
120	142 x 91	138 <sup>1</sup> / <sub>2</sub>	98	74.5	39 <sup>1</sup> / <sub>2</sub>	34 <sup>3</sup> / <sub>4</sub>	71 <sup>3</sup> / <sub>8</sub>	162 <sup>3</sup> / <sub>8</sub>
126	150 x 96	146	102	81	41	36	76	172
132	157 x 101	153	107	89	43	38	80	180
138	164 x 105	159	113	98	45	40	82	184
144	171 x 110	165	118 <sup>1</sup> / <sub>2</sub>	107	47	41	85	190

**Notes:** Dimensions shown are not for specification purposes, subject to manufacturing tolerances.

**Table 1.8 Size and Layout Details — Structural Plate Circular Pipe  
152 mm x 51 mm (6 x 2 in.) Corrugation Profile**

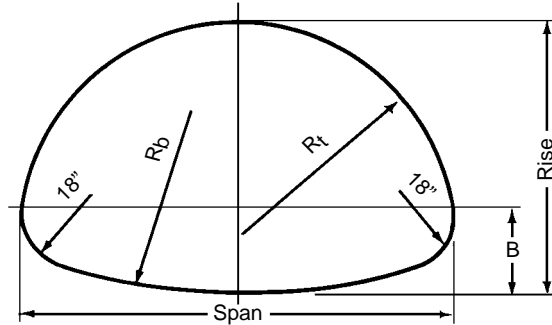
Inside Diameter		Waterway Area		Periphery Total	
(mm)	(ft-in.)	(m <sup>2</sup> )	(ft <sup>2</sup> )	N	Pi
1500	5-0	1.77	19.6	20	60
1665	5-6	2.16	23.7	22	66
1810	6-0	2.58	28.3	24	72
1965	6-6	3.04	33.2	26	78
2120	7-0	3.54	38.5	28	84
2275	7-6	4.07	44.2	30	90
2430	8-0	4.65	50.2	32	96
2585	8-6	5.26	56.7	34	102
2740	9-0	5.91	63.6	36	108
2895	9-6	6.60	70.8	38	114
3050	10-0	7.32	78.5	40	120
3205	10-6	8.09	86.5	42	126
3360	11-0	8.89	95.0	44	132
3515	11-6	9.73	103.8	46	138
3670	12-0	10.61	113.0	48	144
3825	12-6	11.52	122.7	50	150
3980	13-0	12.47	132.7	52	156
4135	13-6	13.46	143.1	54	162
4290	14-0	14.49	153.9	56	168
4445	14-6	15.56	165.0	58	174
4600	15-0	16.66	176.6	60	180
4755	15-6	17.81	188.6	62	186
4910	16-0	18.99	201.0	64	192
5065	16-6	20.20	213.7	66	198
5220	17-0	21.46	226.9	68	204
5375	17-6	22.75	240.4	70	210
5530	18-0	24.08	254.3	72	216
5685	18-6	25.46	268.7	74	222
5840	19-0	26.86	283.4	76	228
5995	19-6	28.31	298.5	78	234
6150	20-0	29.79	314.0	80	240
6305	20-6	31.31	329.9	82	246
6460	21-0	32.87	346.2	84	252
6615	21-6	34.47	362.9	86	258
6770	22-0	36.10	379.9	88	264
6925	22-6	37.77	397.4	90	270
7080	23-0	39.48	415.3	92	276
7235	23-6	41.23	433.5	94	282
7390	24-0	43.01	452.2	96	288
7545	24-6	44.84	471.2	98	294
7700	25-0	46.70	490.6	100	300
7855	25-6	48.60	510.4	102	306
8010	26-0	50.53	530.7	104	312



**Table 1.9M Structural Plate Pipe-Arch Size and Layout Details 152 mm x 51 mm Corrugation — Bolted Seams 457 mm Corner Radius, Rc**

Dimensions		Waterway Area	Layout Dimensions			Periphery Total	
Span	Rise		B	Rt	Rb	N	Pi
(mm)	(mm)	(m <sup>2</sup> )	(mm)	(mm)	(mm)		
1850	1400	2.04	530	940	1940	22	66
1930	1450	2.23	520	970	2500	23	69
2060	1500	2.42	560	1040	2120	24	72
2130	1550	2.60	540	1080	2650	25	75
2210	1600	2.88	530	1110	3460	26	78
2340	1650	3.07	570	1180	2790	27	81
2410	1700	3.25	550	1210	3500	28	84
2490	1750	3.53	530	1240	4650	29	87
2620	1800	3.72	580	1320	3580	30	90
2690	1850	3.99	550	1350	4540	31	93
2840	1910	4.27	600	1430	3670	32	96
2900	1960	4.55	580	1460	4510	33	99
2970	2010	4.83	560	1480	5790	34	102
3120	2060	5.11	610	1560	4530	35	105
3250	2110	5.39	660	1650	3890	36	108
3330	2160	5.67	640	1670	4580	37	111
3480	2210	5.95	700	1760	4010	38	114
3530	2260	6.22	670	1780	4650	39	117
3610	2310	6.60	640	1810	5500	40	120
3760	2360	6.87	700	1900	4740	41	123
3810	2410	7.25	670	1920	5510	42	126
3860	2460	7.53	640	1940	6540	43	129
3910	2540	7.90	610	1960	7990	44	132
4090	2570	8.27	670	2050	6470	45	135
4240	2620	8.64	730	2140	5600	46	138
4290	2670	9.01	700	2160	6450	47	141
4340	2720	9.38	670	2180	7560	48	144
4520	2770	9.75	730	2280	6460	49	147
4670	2820	10.12	800	2370	5760	50	150
4720	2870	10.50	770	2390	6500	51	153
4780	2920	10.96	730	2400	7400	52	156
4830	3000	11.33	700	2430	8590	53	159
5000	3020	11.71	760	2520	7390	54	162
5050	3070	12.17	730	2540	8450	55	165

**Notes:** Dimensions are to inside crests and are subject to manufacturing tolerances. N = 3 Pi = 244 mm

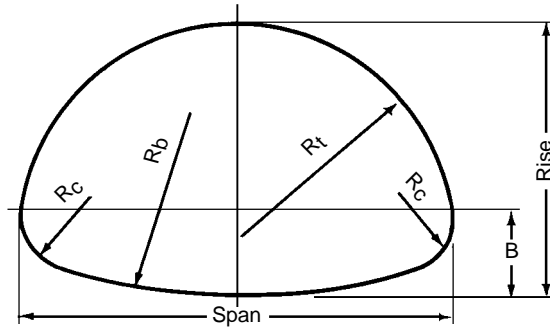


**Table 1.9 Structural Plate Pipe-Arch Size and Layout Details 6 x 2 in. Corrugation — Bolted Seams 18-inch Corner Radius, Rc**

Dimensions		Waterway Area	Layout Dimensions			Periphery Total	
Span	Rise		B	R <sub>t</sub>	R <sub>b</sub>	N	Pi
(ft-in.)	(ft-in.)	(ft <sup>2</sup> )	(in.)	(ft)	(ft)		
6-1	4-7	22	21.0	3.07	6.36	22	66
6-4	4-9	24	20.5	3.18	8.22	23	69
6-9	4-11	26	22.0	3.42	6.96	24	72
7-0	5-1	28	21.4	3.53	8.68	25	75
7-3	5-3	31	20.8	3.63	11.35	26	78
7-8	5-5	33	22.4	3.88	9.15	27	81
7-11	5-7	35	21.7	3.98	11.49	28	84
8-2	5-9	38	20.9	4.08	15.24	29	87
8-7	5-11	40	22.7	4.33	11.75	30	90
8-10	6-1	43	21.8	4.42	14.89	31	93
9-4	6-3	46	23.8	4.68	12.05	32	96
9-6	6-5	49	22.9	4.78	14.79	33	99
9-9	6-7	52	21.9	4.86	18.98	34	102
10-3	6-9	55	23.9	5.13	14.86	35	105
10-8	6-11	58	26.1	5.41	12.77	36	108
10-11	7-1	61	25.1	5.49	15.03	37	111
11-5	7-3	64	27.4	5.78	13.16	38	114
11-7	7-5	67	26.3	5.85	15.27	39	117
11-10	7-7	71	25.2	5.93	18.03	40	120
12-4	7-9	74	27.5	6.23	15.54	41	123
12-6	7-11	78	26.4	6.29	18.07	42	126
12-8	8-1	81	25.2	6.37	21.45	43	129
12-10	8-4	85	24.0	6.44	26.23	44	132
13-5	8-5	89	26.3	6.73	21.23	45	135
13-11	8-7	93	28.9	7.03	18.39	46	138
14-1	8-9	97	27.6	7.09	21.18	47	141
14-3	8-11	101	26.3	7.16	24.80	48	144
14-10	9-1	105	28.9	7.47	21.19	49	147
15-4	9-3	109	31.6	7.78	18.90	50	150
15-6	9-5	113	30.2	7.83	21.31	51	153
15-8	9-7	118	28.8	7.89	24.29	52	156
15-10	9-10	122	27.4	7.96	28.18	53	159
16-5	9-11	126	30.1	8.27	24.24	54	162
16-7	10-1	131	28.7	8.33	27.73	55	165

**Notes:** Dimensions are to inside crests and are subject to manufacturing tolerances. N = 3 Pi = 9.6 in.

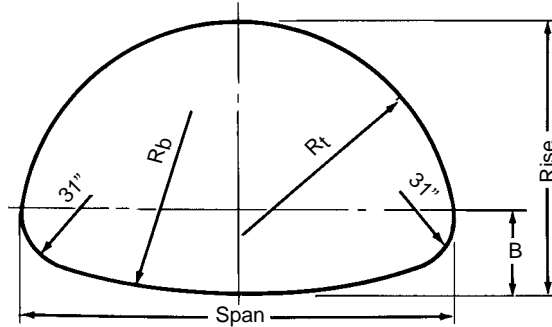




**Table 1.10M Structural Plate Pipe-Arch Size and Layout Details 152 mm x 51mm Corrugation — Bolted Seams 787 mm Corner Radius,  $R_c$**

Dimensions		Waterway Area	Layout Dimensions			Periphery Total	
Span	Rise		B	$R_t$	$R_b$	N	Pi
(mm)	(mm)	(m <sup>2</sup> )	(mm)	(mm)	(mm)		
4040	2840	9.0	980	2040	4890	46	138
4110	2900	9.5	960	2070	5590	47	141
4270	2950	9.8	1010	2140	5030	48	144
4320	3000	10.1	990	2170	5650	49	147
4390	3050	10.6	960	2200	6520	50	150
4550	3100	11.0	1010	2280	5790	51	153
4670	3150	11.4	1060	2370	5300	52	156
4750	3200	11.8	1040	2390	5890	53	159
4830	3250	12.3	1020	2420	6620	54	162
4950	3300	12.7	1070	2500	6000	55	165
5030	3350	13.2	1040	2530	6680	56	168
5180	3400	13.6	1100	2620	6120	57	171
5230	3450	14.0	1070	2640	6780	58	174
5310	3510	14.6	1050	2660	7570	59	177
5460	3560	15.0	1100	2750	6870	60	180
5510	3610	15.5	1080	2770	7610	61	183
5660	3660	16.0	1140	2860	6970	62	186
5720	3710	16.4	1110	2880	7680	63	189
5870	3760	16.9	1170	2970	7080	64	192
5940	3810	17.5	1140	3000	7750	65	195
5990	3860	18.0	1110	3020	8550	66	198
6070	3910	18.6	1080	3040	9510	67	201
6220	3960	19.0	1140	3130	8590	68	204
6270	4010	19.6	1110	3150	9490	69	207

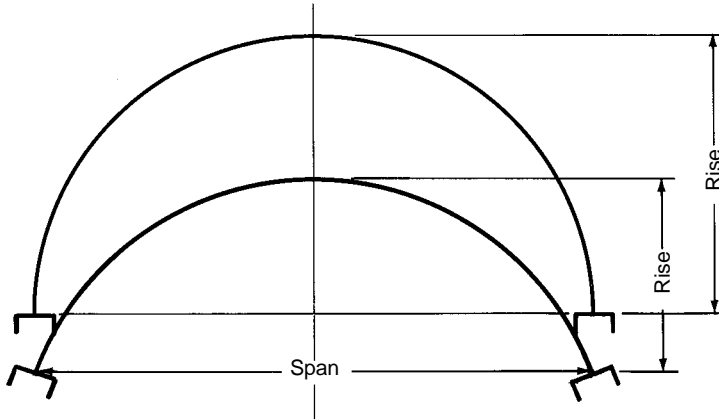
**Notes:** Dimensions are to inside crests and are subject to manufacturing tolerances.  $N = 3 \text{ Pi} = 244 \text{ mm}$



**Table 1.10 Structural Plate Pipe-Arch Size and Layout Details 6 x 2 in. Corrugation — Bolted Seams 31 in. Corner radius,  $R_c$**

Dimensions		Waterway Area (ft <sup>2</sup> )	Layout Dimensions			Periphery Total	
Span (ft-in.)	Rise (ft-in.)		B (in.)	R <sub>t</sub> (ft)	R <sub>b</sub> (ft)	N	Pi
13-3	9-4	97	38.5	6.68	16.05	46	138
13-6	9-6	102	37.7	6.78	18.33	47	141
14-0	9-8	105	39.6	7.03	16.49	48	144
14-2	9-10	109	38.8	7.13	18.55	49	147
14-5	10-0	114	37.9	7.22	21.38	50	150
14-11	10-2	118	39.8	7.48	18.98	51	153
15-4	10-4	123	41.8	7.76	17.38	52	156
15-7	10-6	127	40.9	7.84	19.34	53	159
15-10	10-8	132	40.0	7.93	21.72	54	162
16-3	10-10	137	42.1	8.21	19.67	55	165
16-6	11-0	142	41.1	8.29	21.93	56	168
17-0	11-2	146	43.3	8.58	20.08	57	171
17-2	11-4	151	42.3	8.65	22.23	58	174
17-5	11-6	157	41.3	8.73	24.83	59	177
17-11	11-8	161	43.5	9.02	22.55	60	180
18-1	11-10	167	42.4	9.09	24.98	61	183
18-7	12-0	172	44.7	9.38	22.88	62	186
18-9	12-2	177	43.6	9.46	25.19	63	189
19-3	12-4	182	45.9	9.75	23.22	64	192
19-6	12-6	188	44.8	9.83	25.43	65	195
19-8	12-8	194	43.7	9.90	28.04	66	198
19-11	12-10	200	42.5	9.98	31.19	67	201
20-5	13-0	205	44.9	10.27	28.18	68	204
20-7	13-2	211	43.7	10.33	31.13	69	207

**Notes:** Dimensions are to inside crests and are subject to manufacturing tolerances.  $N = 3 \text{ Pi} = 9.6 \text{ in.}$



**Table 1.11M Structural Plate – Representative Sizes 152 mm x 51 mm Corrugation – Bolted Seams**

Inside Dimensions*		Waterway Area**	Rise over Span***	Radius	Periphery Total	
Span	Rise				N	Pi
(mm)	(mm)	(m <sup>2</sup> )		(mm)		
1830	550	0.70	0.30	1040	9	27
	700	1.16	0.38	950	10	30
	970	1.39	0.53	910	12	36
2130	710	1.11	0.34	1140	11	33
	860	1.39	0.40	1090	12	36
	1120	1.86	0.53	1070	14	42
2440	640	1.58	0.37	1300	13	39
	1020	1.86	0.42	1230	14	42
	1270	2.42	0.52	1220	16	48
2740	640	1.72	0.32	1500	14	42
	1180	2.46	0.43	1400	16	48
	1440	3.07	0.53	1370	18	54
3050	1050	2.32	0.35	1630	16	48
	1350	3.16	0.44	1540	18	54
	1600	3.81	0.52	1520	20	60
3350	1070	2.55	0.32	1850	17	51
	1360	3.44	0.41	1710	19	57
	1750	4.65	0.52	1680	22	66
3660	1230	3.25	0.34	1970	19	57
	1520	4.18	0.42	1850	21	63
	1910	5.48	0.52	1830	24	72
3960	1240	3.53	0.32	2200	20	60
	1550	4.55	0.39	2040	23	66
	2060	6.50	0.52	1980	26	78
4270	1410	4.65	0.33	2310	22	66
	1700	5.39	0.40	2180	24	72
	2210	7.43	0.52	2130	28	84
4570	1410	4.65	0.31	2590	23	69
	1730	5.76	0.38	2360	25	75
	2010	6.97	0.44	2310	27	81
	2360	8.55	0.52	2290	30	90

**Notes:** \* Dimensions are to inside crests and are subject to manufacturing tolerances.  
 \*\* End area under soffit above spring line.  
 \*\*\* R/S ratio varies from 0.30 to 0.53. Intermediate spans and rises are available.

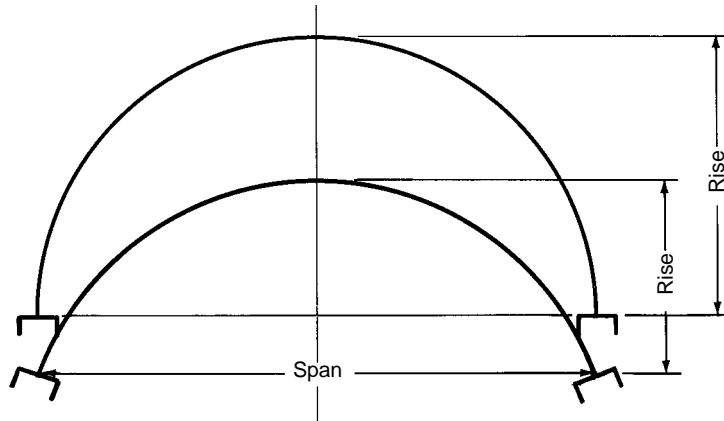
**Table 1.11M Structural Plate – Representative Sizes 152 mm x 51 mm  
(Cont.) Corrugation – Bolted Seams**

Inside Dimensions*		Waterway Area**	Rise over Span***	Radius	Periphery Total	
Span	Rise				N	Pi
(mm)	(mm)	(m <sup>2</sup> )		(mm)		
4880	1570	5.57	0.32	2670	25	75
	2160	7.99	0.45	2460	29	87
	2510	9.75	0.52	2440	32	96
5180	1590	5.85	0.31	2920	26	78
	2180	8.55	0.42	2620	30	90
	2690	11.06	0.52	2590	34	96
5490	1750	6.97	0.32	3020	28	84
	2340	9.66	0.43	2770	32	96
	2720	11.71	0.50	2740	35	111
5790	1930	8.08	0.33	3120	30	90
	2490	10.96	0.43	2920	34	102
	2880	13.01	0.50	2900	37	111
6100	1930	8.45	0.32	3380	31	93
	2530	11.52	0.42	3100	35	105
	3050	14.59	0.50	3050	39	123
6400	2110	9.66	0.33	3480	33	99
	2690	13.00	0.42	3250	37	111
	3200	15.98	0.50	3200	41	123
6710	2110	10.13	0.31	3710	34	102
	2720	13.56	0.40	3430	38	114
	3350	17.65	0.50	3350	43	129
7010	2440	12.45	0.35	3730	37	117
	3000	15.89	0.43	3560	41	123
	3510	19.32	0.50	3510	45	135
7320	2590	13.94	0.35	3860	39	117
	3150	17.47	0.43	3710	43	129
	3660	21.00	0.50	3660	47	141
7620	2600	14.40	0.34	4060	40	120
	3310	19.23	0.43	3860	45	135
	3810	22.95	0.50	3810	49	147

**Notes:** \* Dimensions are to inside crests and are subject to manufacturing tolerances.

\*\* End area under soffit above spring line.

\*\*\*R/S ratio varies from 0.30 to 0.53. Intermediate spans and rises are available.



**Table 1.11 Structural Plate Arch — Representative Sizes  
6 x 2 in. Corrugation — Bolted Seams**

Inside Dimensions*		Waterway Area**	Rise Over Span***	Radius	Periphery Total	
Span	Rise				N	Pi
(ft)	(ft-in.)	(ft <sup>2</sup> )		(in.)		
6.0	1-9/2	7 1/2	0.30	41	9	27
	2-3 1/2	10	0.38	37 1/2	10	30
	3-2	15	0.53	36	12	36
7.0	2-4	12	0.34	45	11	33
	2-10	15	0.40	43	12	36
	3-8	20	0.52	42	14	42
8.0	2-11	17	0.37	51	13	39
	3-4	20	0.42	48 1/2	14	42
	4-2	26	0.52	48	16	48
9.0	2-11	18 1/2	0.32	59	14	42
	3-10 1/2	26 1/2	0.43	55	16	48
	4-8 1/2	33	0.52	54	18	54
10.0	3-5 1/2	25	0.35	64	16	48
	4-5	34	0.44	60 1/2	18	54
	5-3	41	0.52	60	20	60
11.0	3-6	27 1/2	0.32	73	17	51
	4-5 1/2	37	0.41	67 1/2	19	57
	5-9	50	0.52	66	22	66
12.0	4-0 1/2	35	0.34	77 1/2	19	57
	5-0	45	0.42	73	21	63
	6-3	59	0.52	72	24	72
13.0	4-1	38	0.32	86 1/2	20	60
	5-1	49	0.39	80 1/2	22	66
	6-9	70	0.52	78	26	78
14.0	4-7 1/2	47	0.33	91	22	66
	5-7	58	0.40	86	24	72
	7-3	80	.052	84	28	84

**Notes:** \* Dimensions are to inside crests and are subject to manufacturing tolerances.

\*\* End area under soffit above spring line.

\*\*\* R/S ratio varies from 0.30 to 0.53. Intermediate spans and rises are available.

**Table 1.11 Structural Plate Arch — Representative Sizes (Cont.) 6 x 2 in. Corrugation — Bolted Seams**

Inside Dimensions*		Waterway Area**	Rise Over Span***	Radius	Nominal Arc Length	
Span	Rise				N	Pi
(ft)	(ft-in.)	(ft <sup>2</sup> )		(in.)		
15.0	4-7½	50	0.31	101	23	69
	5-8	62	0.38	93	25	75
	6-7	75	0.44	91	27	81
	7-9	92	0.52	90	30	90
16.0	5-2	60	0.32	105	25	75
	7-1	86	0.45	97	29	87
	8-3	105	0.52	96	32	96
17.0	5-2½	63	0.31	115	26	78
	7-2	92	0.42	103	30	90
	8-10	119	0.52	96	34	96
18.0	5-9	75	0.32	119	28	84
	7-8	104	0.43	109	32	96
	8-11	126	0.50	114	35	111
19.0	6-4	87	0.33	123	30	90
	8-2	118	0.43	115	34	102
	9-5½	140	0.50	114	37	111
20.0	6-4	91	0.32	133	31	93
	8-3½	124	0.42	122	35	105
	10-0	157	0.50	126	39	123
21.0	6-11	104	0.33	137	33	99
	8-10	140	0.42	128	37	111
	10-6	172	0.50	126	41	123
22.0	6-11	109	0.31	146	34	102
	8-11	146	0.40	135	38	114
	11-0	190	0.50	132	43	129
23.0	8-0	134	0.35	152	37	117
	9-10	171	0.43	140	41	123
	11-6	208	0.50	138	45	135
24.0	8-6	150	0.35	152	39	117
	10-4	188	0.43	146	43	129
	12-0	226	0.50	144	47	141
25.0	8-6½	155	0.34	160	40	120
	10-10½	207	0.43	152	45	135
	12-6	247	0.50	150	49	147

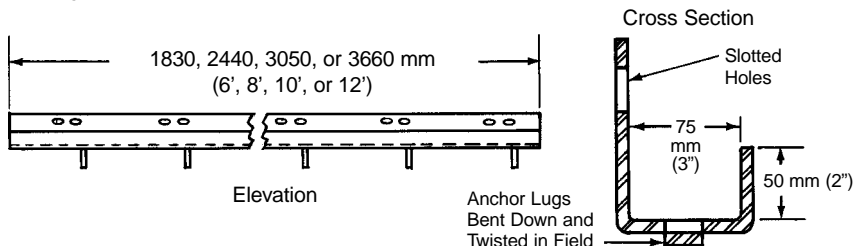
**Notes:** \* Dimensions are to inside crests and are subject to manufacturing tolerances.

\*\* End area under soffit above spring line.

\*\*\*R/S ratio varies from 0.30 to 0.53. Intermediate spans and rises are available.

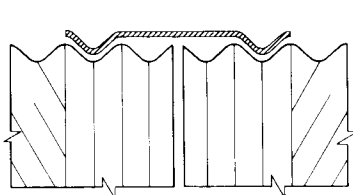
**Arch Channels**

For arch seats, galvanized unbalanced channels with anchor lugs are available. See Figure 1.1 below.

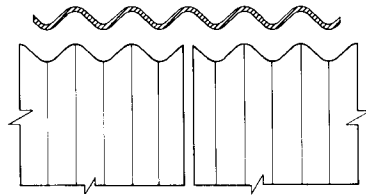


**Figure 1.1** General dimensions of unbalanced channels for structural plate arches.

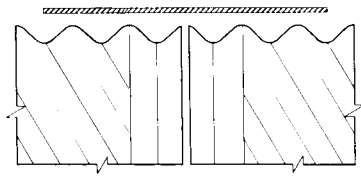
**Standard Couplers**



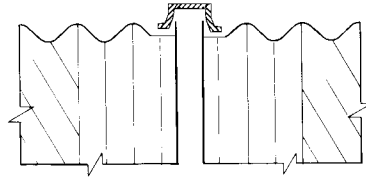
Semi-Corrugated (Hugger)



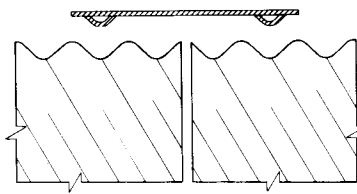
Corrugated (Annular)



Flat



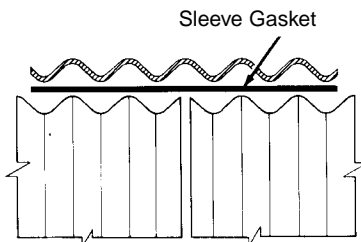
Hat



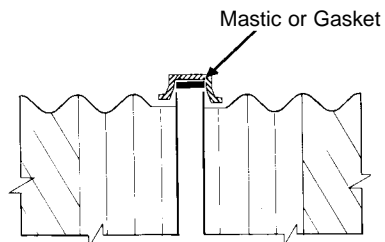
Universal\*

\*Unless a dimple fills each corrugation valley, a suitable gasket or geotextile wrap is required

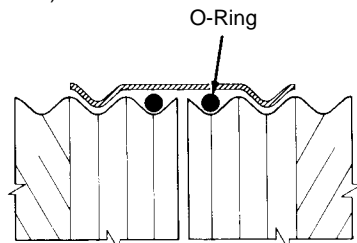
**Gasketed Couplers**



Corrugated (Anular)



Hat



Semi-Corrugated (Hugger)

## CSP COUPLING SYSTEMS

The functional requirements for pipe joints are specified in the AASHTO Bridge Design Specification, Section 26.4.2. The design of field joints using these criteria is covered in Chapter 7.

A wide variety of pipe joints are available for field connecting lengths of corrugated steel pipe. The drawings on the previous page illustrate and define the standard joints which can be classified as Soil-tight and Watertight. Other equally effective couples may be designed and supplied based on specific project needs.

### Standard Couplers







Coupler systems are intended to maintain structural integrity of the pipe connection while reducing the infiltration of soil particles into the pipe. The specifier must first consider the backfill surrounding the coupler along with the flow conditions the pipe will experience. Course sand and gravel, and fine clay materials, with a plastic index greater than 12, are generally too large or well adhered to infiltrate. Pipes with annular re-rolled ends and external coupling bands, that form a tight metal-to-metal contact around the pipe, provide adequate tightness to limit infiltration of courser backfill materials.

When pipe is buried in a silt or fine sand backfill and flows rise and fall quickly, tighter systems may be necessary. These very fine, granular backfill materials can be prevented from infiltrating into a pipe by providing a geotextile wrap around the exterior of the pipe.

### Gasketed Couplers

In those rare instances where excessive leakage may occur, a gasketed coupling system may be required. Leakage limits are dictated by specific project conditions such as when the pipe system is located below the groundwater table or when it is carrying hazardous pollutants. Gasketed coupling systems required to meet specific leakage limits should be pre-qualified through plant or laboratory testing, with the test conducted in a zero pressure environment. True "watertight" systems are rarely required.

**Table 1.12 Coupling Bands For Corrugated Steel Pipe**

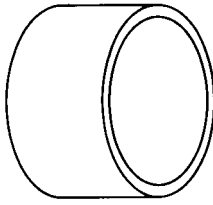
Type of Band	Cross Section	Angles	Bar Bolt, & Strap	Gaskets			Pipe End		
				O-Ring	Sleeve or Strip	Mastic	Annular Plain	Helical	
								Plain	Reformed
Universal		X	X		X	X	X	X	X
Corrugated		X	X		X	X	X	X	X
Semi-Corrugated		X	X	X		X	X	X	
Channel		X	X	X		X	X		X
Flat		X	X	X	X	X	X	X	X
Wing Channel		X	X			X			



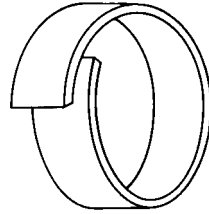
**Standard CSP Gaskets**



O-Ring Gasket



Sleeve Gasket

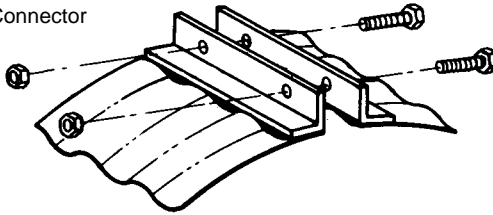


Strip Gasket or  
Geotextile Wrap

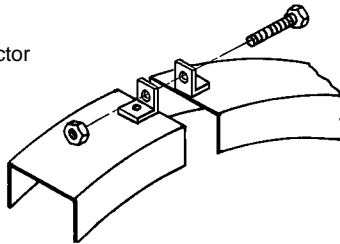
**Standard CSP Band Connectors**

The following band connectors are used with CSP coupling systems:

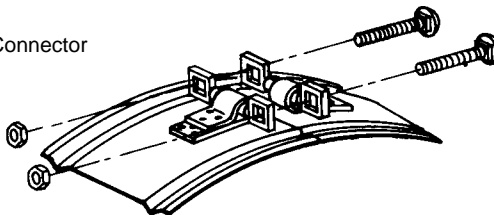
Band Angle Connector



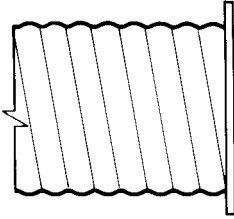
Clip or Lug Angle Connector



Bar and Strap Connector

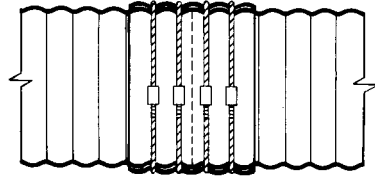


For unusual conditions (i.e., high pressures, extreme disjuncting forces, threading pipe inside existing pipe, jacking or boring pipe, and deep vertical drop inlets), a variety of special designs are available or a new special joint may be designed by the manufacturer to meet a new requirement.



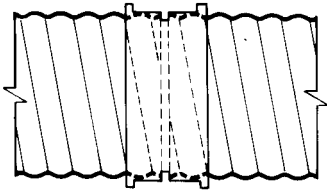
#### Flat Joint

Bolted Flanges are attached to pipe ends.



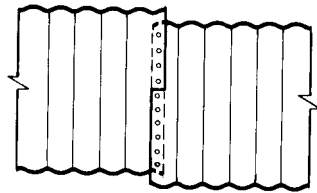
#### Rod & Lug

Band is secured by rod around band connected by lugs.



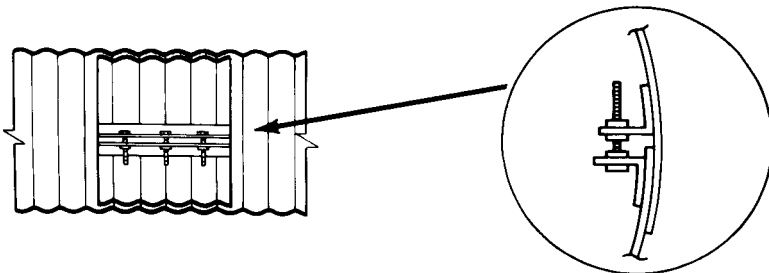
#### Sleeve Joint

Smooth sleeve with center stop. Stab type joint.



#### Jacking or Threading

Boring-Pipe slit, stabs together, may be bolted if required.



#### Internal Type

## CSP FITTINGS AND SEWER APPURTENANCES

An important feature of corrugated steel pipe sewers is the wide range of fittings and appurtenances that can be employed. The nature of the material makes possible almost any special fitting that can be designed. When possible, it is generally most economical to use the most commonly produced or “standard” fittings. To guide the designer, presented herein are the typical fittings and appurtenances fabricated throughout the country.

Sewer system hardware such as grates, manhole covers, ladders and steps are easily incorporated in corrugated steel manholes or inlets. The following pages illustrate how this hardware is used in corrugated steel structures.

### Fittings

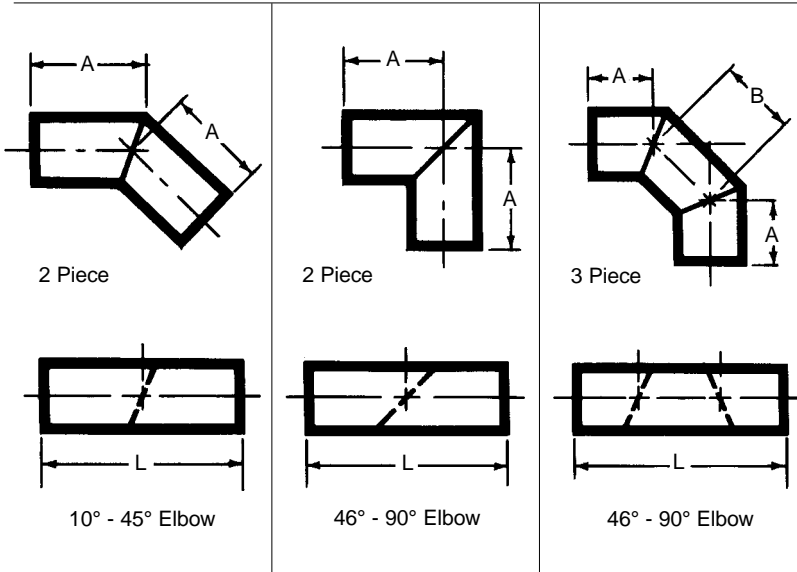
Tables 1.13, 1.14 and 1.15 list the standard or minimum dimensions of common fittings and elbows. Note that these are minimum dimensions. It may be most practical in some cases to fabricate fittings with longer legs than those shown here. It is ordinarily best to let the contractor and supplier work out such details. However, it may be useful for the designer to have these minimum dimensions in laying out turns or intersections where precision is required.

Pipe sizes larger than those shown in these tables should be individually designed. The larger sizes can require longer leg dimensions, depending on wall thickness and type of pipe fabrication.



Manifold system used for underground detention.

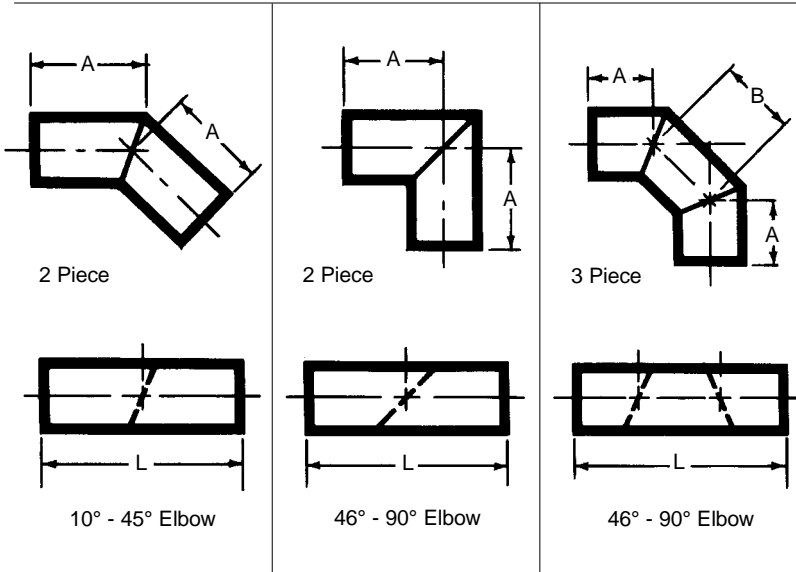
**Table 1.13M Minimum Dimensions for Elbows for Round CSP (mm)  
All Corrugations**



Pipe Diameter (mm)	A (mm)	Total Length (mm)	Pipe Diameter (mm)	A (mm)	Total Length (mm)	Pipe Diameter (mm)	A (mm)	B (mm)	C (mm)	Total Length (mm)
150 - 450	300	600	150 - 250	300	600	150	340	200	200	600
525 - 1200	600	1200	300 - 675	600	1200	200	360	230	190	600
1350 - 2400	900	1800	750 - 1050	900	1800	250	360	250	180	600
			1200 - 1650	1200	2400	300	650	280	470	1200
			1800 - 2400	1500	3000	375	670	300	470	1200
			2250 - 2400	1800	6000	450	690	360	460	1200
						525	690	380	430	1200
						600	700	410	420	1200
						675	700	430	410	1200
						750	1020	480	670	1800
						825	1020	510	660	1800
						900	1030	530	650	1800
						1050	1040	580	620	1800
						1200	1360	660	890	2400
						1350	1370	710	860	2400
						1500	1380	790	830	2400
						1650	1370	840	800	2400
						1800	1710	910	1070	3000
						1950	1730	990	1030	3000
						2100	1740	1040	1000	3000
						2250	1780	1170	940	3000
						2400	2080	1170	1240	3600

**Notes:** The total length (mm) and pipe diameter (mm) listed are minimum requirements for fitting fabrication. Fittings with other dimensions to satisfy specific needs are also available. All dimensions are nominal. **All dimensions are in millimeters.**

**Table 1.13 Minimum Dimensions for Elbows for Round CSP  
All Corrugations**



Pipe Diameter (in.)	A (ft)	Total Length (ft)	Pipe Diameter (in.)	A (ft)	Total Length (ft)	Pipe Diameter (in.)	A (in.)	B (in.)	C (in.)	Total Length (ft)
6-18	1	2	6-10	1	2	6	13½	8	8	2
21-48	2	4	12-27	2	4	8	14	9	7½	2
54-96	3	6	30-42	3	6	10	14	10	7	2
			48-66	4	8	12	25½	11	18½	4
			72-84	5	10	15	26½	12	18	4
			90-96	6	12	18	27	14	17	4
						21	27	15	16½	4
						24	27½	16	16	4
						27	27½	17	15½	4
						30	40	19	26½	6
						33	40	20	26	6
						36	40½	21	25½	6
						42	41	23	24½	6
						48	53½	26	35	8
						54	54	28	34	8
						60	54½	31	32½	8
						66	54	33	31½	8
						72	67½	36	42	10
						78	68	39	40½	10
						84	68½	41	39½	10
						90	70	46	37	10
						96	82	46	49	12

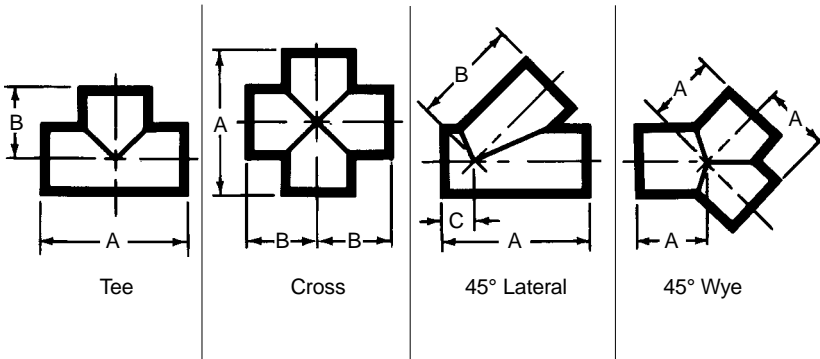
**Notes:** The total length (ft) and pipe diameter (in.) listed are minimum requirements for fitting fabrication. Fittings with other dimensions to satisfy specific needs are also available. All dimensions are nominal.

**Table 1.14M Minimum Dimensions for CSP Round Fittings (mm)**

Main Diam.  (mm)	Stub Same or Smaller Than Main Diameter										45° Wye		
	Tee			Cross			45° Lateral				A	B	TL
	A	B	TL	A	B	TL	A	B	C	TL			
150	600	600	1200	600	600	1200	600	600	200	1200	600	600	1800
200	600	600	1200	600	600	1200	600	600	200	1200	600	600	1800
250	600	600	1000	600	600	1200	1200	600	430	1800	600	600	1800
300	1200	600	1800	1200	1200	2400	1200	600	430	1800	600	600	1800
375	1200	600	1800	1200	1200	2400	1200	1200	460	2400	600	600	1800
450	1200	600	1800	1200	1200	2400	1200	1200	330	2400	600	600	1800
525	1200	600	1800	1200	1200	2400	1500	900	560	2400	600	600	1800
600	1200	600	1800	1200	1200	2400	1800	1200	580	3000	600	600	1800
675	1200	600	1800	1200	1200	2400	1800	1200	510	3000	600	600	1800
750	1200	600	1800	1200	1200	2400	1800	1200	530	3000	600	600	1800
825	1800	1200	3000	1800	1800	3600	1800	1800	480	3600	600	900	2400
900	1800	1200	3000	1800	1800	3600	2400	1800	460	4200	600	900	2400
1050	1800	1200	3000	1800	1800	3600	2400	1800	530	4200	600	900	2400
1200	1800	1200	3000	1800	1800	3600	3000	2400	460	4800	600	900	2400
1350	1800	1200	3000	1800	1800	3600	3000	2400	580	5400	1200	1200	3600
1650	2400	1200	3600	2400	2400	4800	3600	3600	810	6600	1200	1200	3600
1800	2400	1200	3600	2400	2400	4800	4200	3000	1140	7200	1200	1500	4200
1950	3000	1800	4500	3000	3000	6000	4800	3600	1170	8400	1200	1500	4200
2100	3000	1800	4500	3000	3000	6000	4800	3600	1190	8400	1200	1500	4200
2250	3000	1800	4500	3000	3000	6000	4800	3600	1240	8400	1200	1500	4200
2400	3000	1800	4800	3000	3000	6000	4800	3600	1270	8400	1200	1800	4800

**Notes:** TL - total net length needed to fabricate fitting  
**All dimensions are in millimeters.**

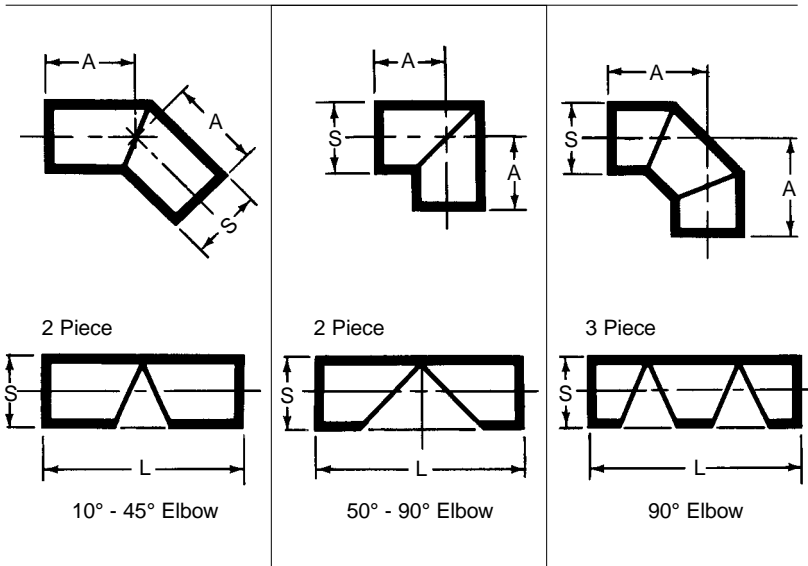
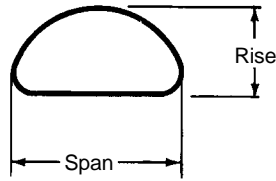
**Table 1.14 Minimum Dimensions for CSP Round Fittings (in., ft)**



Main Diam.	Stub Same or Smaller Than Main Diameter										45° Wye		
	Tee			Cross			45° Lateral						
	A	B	TL	A	B	TL	A	B	C	TL	A	B	TL
(in.)	(ft)	(ft)	(ft)	(ft)	(ft)	(ft)	(ft)	(ft)	(in.)	(ft)	(ft)	(ft)	(ft)
6	2	2	4	2	2	4	2	2	8	4	2	2	6
8	2	2	4	2	2	4	2	2	8	4	2	2	6
10	2	2	4	2	2	4	4	2	17	6	2	2	6
12	4	2	6	4	4	8	4	2	17	6	2	2	6
15	4	2	6	4	4	8	4	4	18	8	2	2	6
18	4	2	6	4	4	8	4	4	13	8	2	2	6
21	4	2	6	4	4	8	6	4	22	10	2	2	6
24	4	2	6	4	4	8	6	4	23	10	2	2	6
27	4	2	6	4	4	8	6	4	20	10	2	2	6
30	4	2	6	4	4	8	6	4	21	10	2	2	6
33	6	4	10	6	6	12	6	6	19	12	2	3	8
36	6	4	10	6	6	12	8	6	19	14	2	3	8
42	6	4	10	6	6	12	8	6	21	14	2	3	8
48	6	4	10	6	6	12	10	8	28	18	2	3	8
54	6	4	10	6	6	12	10	8	23	18	4	4	12
60	8	4	12	8	8	16	12	10	30	22	4	4	12
66	8	4	12	8	8	16	12	10	32	22	4	4	12
72	8	4	12	8	8	16	14	10	45	24	4	5	14
78	10	6	16	10	10	20	14	10	46	24	4	5	14
84	10	6	16	10	10	20	16	12	47	28	4	5	14
90	10	6	16	10	10	20	16	12	49	28	4	5	14
96	10	6	16	10	10	20	16	12	50	28	4	6	16

**Notes:** TL - total net length needed to fabricate fitting.

**Table 1.15M Minimum Dimensions for CSP Pipe-Arch Elbow Fittings**

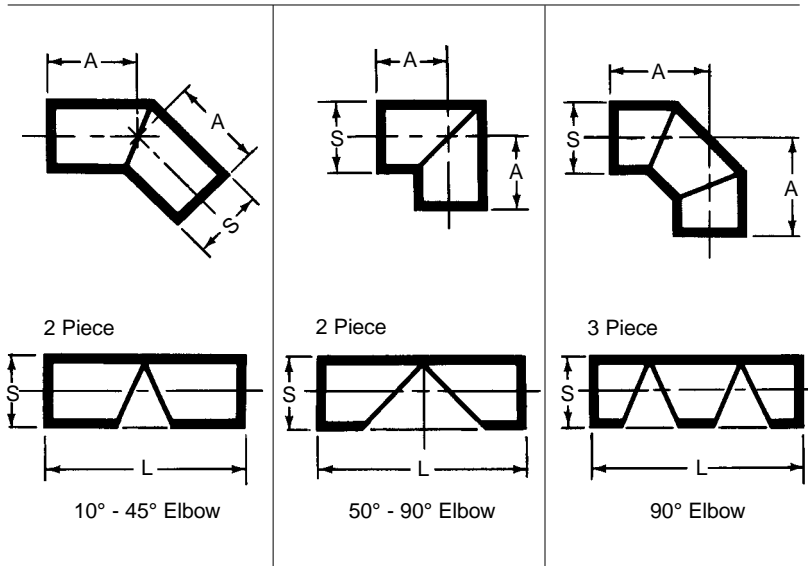
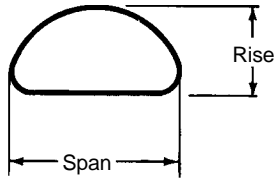


Equivalent Round Diameter	Span S	Rise R	45° Elbow 2 Piece		90° Elbow 2 Piece		90° Elbow 3 Piece	
			A	L	A	L	A	L
(mm)	(mm)	(mm)	(mm)	(mm)	(mm)	(mm)	(mm)	(mm)
375	430	330	510	1200	690	1800	790	1800
450	530	380	510	1200	640	1800	760	1800
525	610	460	480	1200	610	1800	740	1800
600	710	510	460	1200	860	2400	710	1800
750	885	610	410	1200	760	2400	970	2400
900	1060	740	690	1800	970	3000	890	2400
1050	1240	840	640	1800	890	3000	1140	3000
1200	1440	970	610	1800	1090	3600	1060	3000
1350	1620	1100	860	2400	1320	4200	1320	3600
1500	1800	1200	840	2400	1520	4800	1570	4200
1650	1950	1320	1090	3000	1420	4800	1520	4200
1800	2100	1450	1070	3000	1420	5400	1780	4800

**Notes:** All dimensions are nominal  
L—length for fabrication



**Table 1.15 Minimum Dimensions for CSP Pipe-Arch Elbow Fittings**

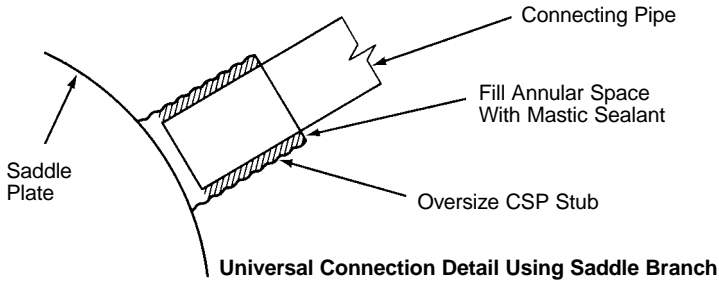


Equivalent Round Diameter	Span S	Rise R	45° Elbow 2 Piece		90° Elbow 2 Piece		90° Elbow 3 Piece	
			A	L	A	L	A	L
(in.)	(in.)	(in.)	(in.)	(ft)	(in.)	(ft)	(in.)	(ft)
15	17	13	20	4	27	6	31	6
18	21	15	20	4	25	6	30	6
21	24	18	19	4	24	6	29	6
24	28	20	18	4	34	8	28	6
30	35	24	16	4	30	8	38	8
36	42	29	27	6	38	10	35	8
42	49	33	25	6	35	10	45	10
48	57	38	24	6	43	12	42	10
54	64	43	34	8	52	14	52	12
60	71	47	33	8	60	16	62	14
66	77	52	43	10	56	16	60	14
72	83	57	42	10	56	18	70	16

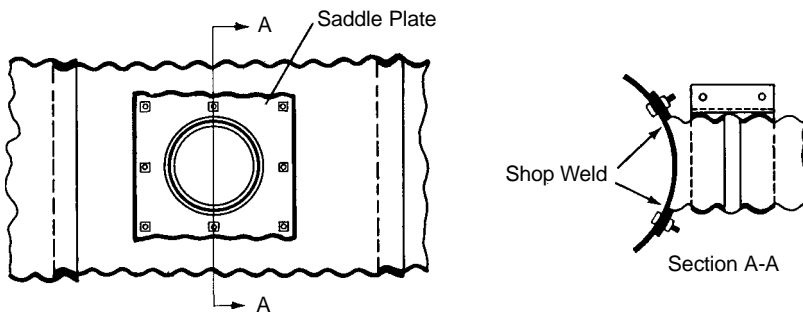
**Notes:** All dimensions are nominal  
L—length for fabrication

## Saddle Branch

Saddle branches are used to connect smaller branch lines to the main. Saddles make it practical to accurately tie in connections after the main line is laid. Or, new connections can be effectively made on old lines with saddles. Saddles can be used to connect almost any type of pipe to a CSP main. A common “universal” type of saddle branch stub to do this is shown below.



Typical pre-fabricated CSP saddle branch fitting used in connecting house laterals or incoming pipe from catch basins.



Side View of Sewer with Saddle Branch in Place

**Figure 1.2** Saddle branch, bolted to main sewer on the job or at the plant, enables laterals and house connections to join the sewer.

## Transitions

Changes in pipe diameter should be accomplished in junction structures. However, there are circumstances when a pipe reducer or enlarger section is desired.

A simple, instant size change can be done as shown in Figure 1.3.

Tapered transitions may be fabricated in smooth steel for helical pipe systems as shown in Figure 1.4. Reinforcement may be required.

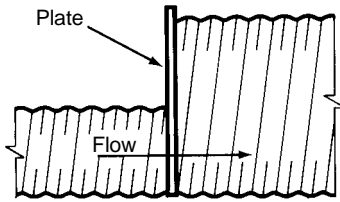


Figure 1.3 Enlarger

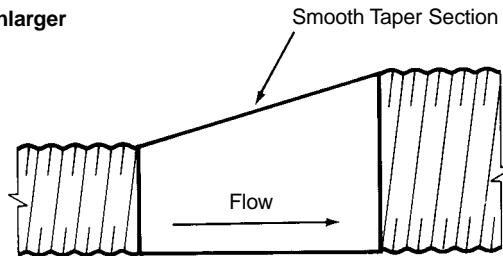


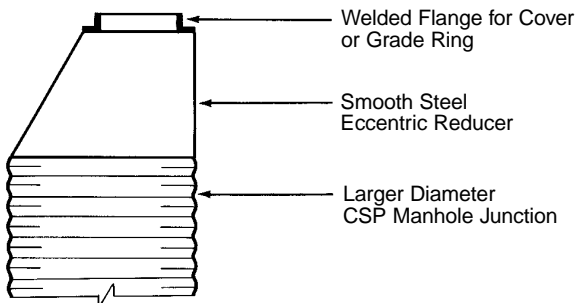
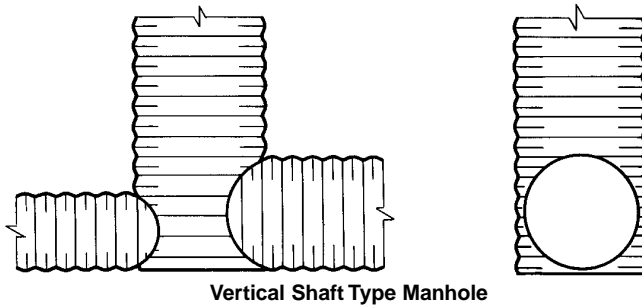
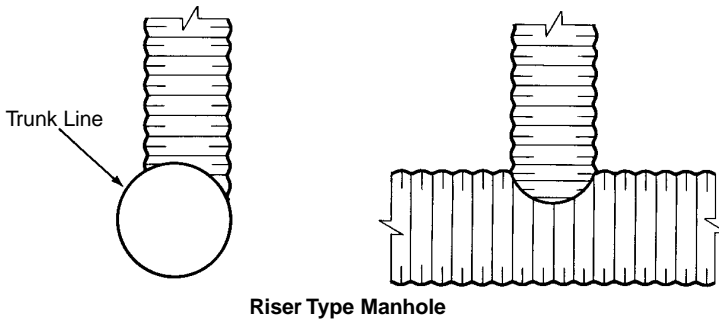
Figure 1.4 Eccentric Transition



Saddle branch manhole is bolted to sewer conduit while riser extension is being lowered and coupled.

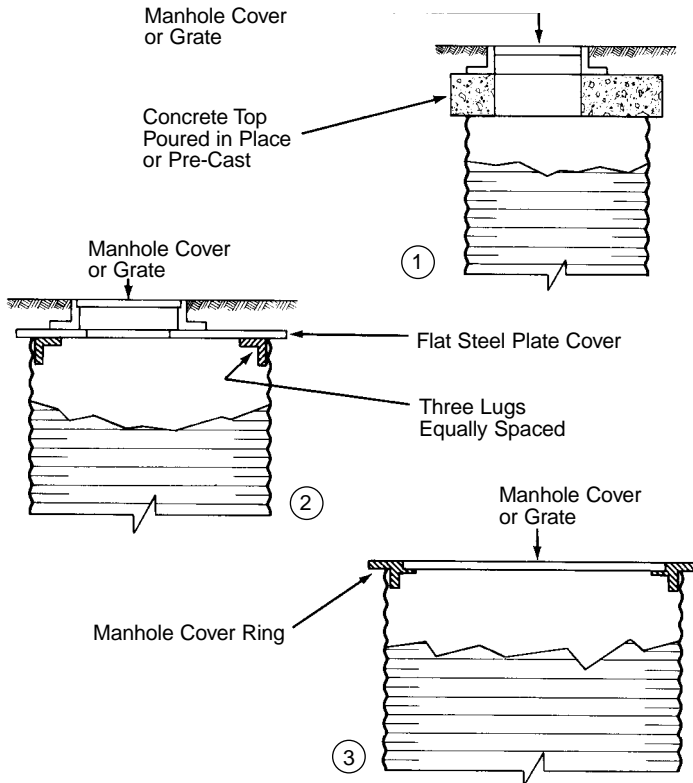
## Manholes and Catch Basins

Manholes are available in corrugated pipe construction in two basic types as shown below. The riser type of manhole is the simpler of the two and quite economical. It is only feasible for trunk lines of 900 mm (36 in.) diameter or greater. When junctions of smaller diameters are involved, it is possible to use a vertical shaft of larger diameter CSP to connect the sewers. However, when the shaft is greater than 900 mm (36 in.) in diameter, some reduction detail must be used to suit the cover. Typical reduction details are shown below.



**Reduction Details**

**Manhole and Catch Basin Tops**

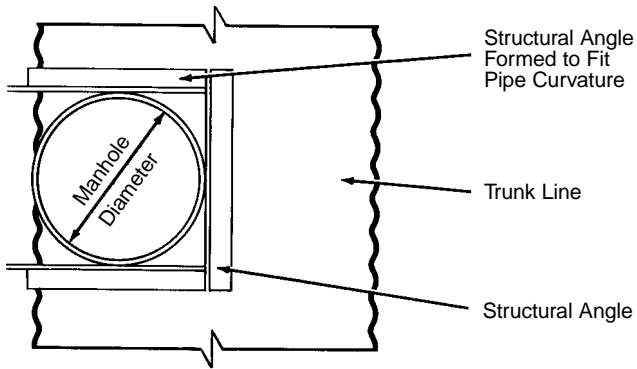


Detail (1) can be used with almost any type of surface cover or grate. Concrete grade ring may be augmented with brick to raise cover elevation in the future. Alternatively, added concrete may be poured. Direct connections of cast or fabricated plates or rings as in (2) and (3) are particularly suitable for grated inlet openings.



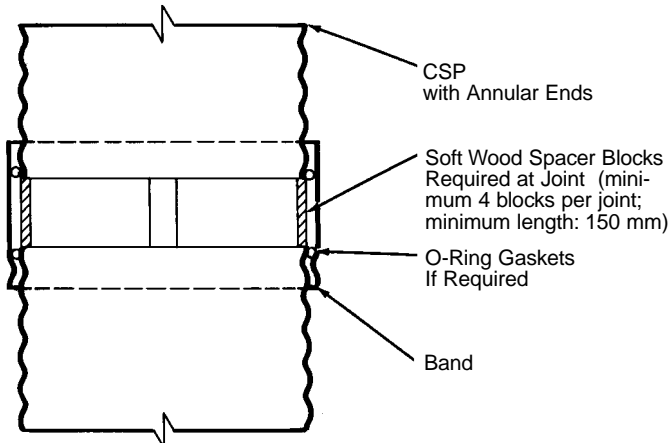
Standard cast iron covers and/or steel grates are used with CSP manholes and catch basins.

### Manhole Reinforcing



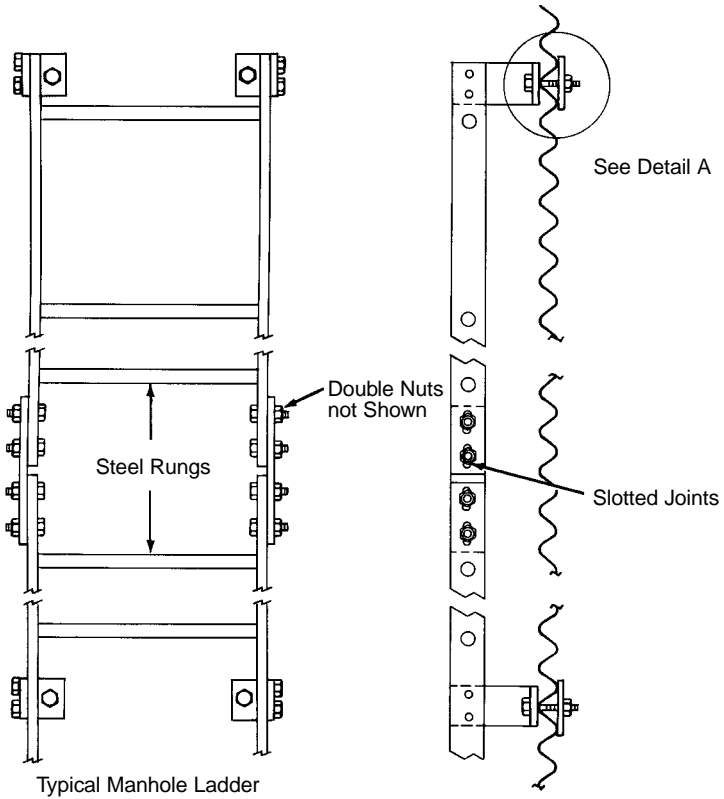
Use of manhole reinforcing may be required, particularly for larger diameters.

### Manhole Slip Joints

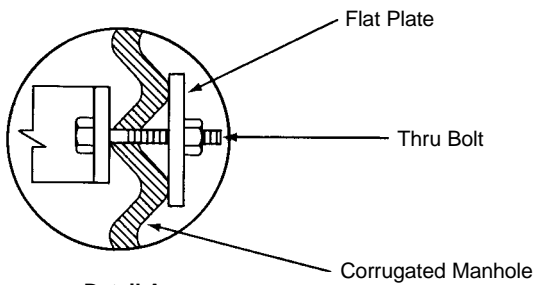


Heavily loaded manholes sometimes make slip joints desirable. Shown above is one method of providing a slip joint, which allows settlement in the riser.

### Manhole Ladder



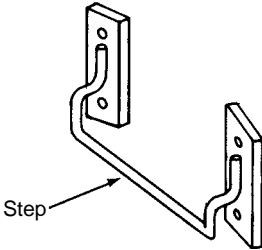
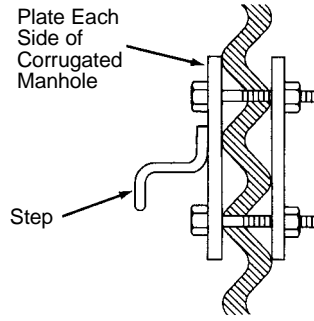
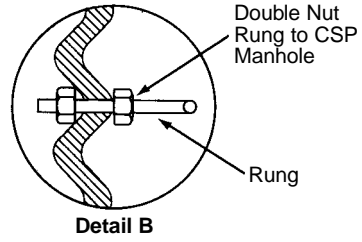
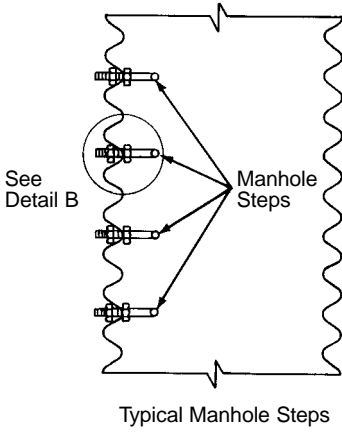
Typical Manhole Ladder



**Detail A**  
Typical Ladder Bracket Attachment

1. Ladder may be constructed in one length.
2. Use bolts with double nuts to connect splice plate at ladder joint to allow vertical movement.
3. Hot-dip galvanizing of all ladder components is recommended.

### Manhole Steps



CSP catch basin with concrete slab and standard cast-iron frame and cover.



### **CSP Slotted Drain Inlets**

By welding a narrow section of grating in the top of a corrugated steel pipe, a continuous grate inlet is achieved. Originally conceived to pick up sheet flow in roadway medians, parking lots, airports, etc., this product has proven even more useful in curb inlets.



CSP concrete-lined pipe.

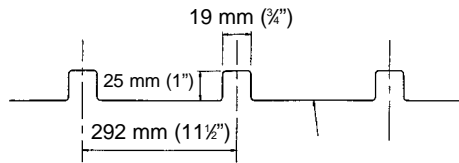
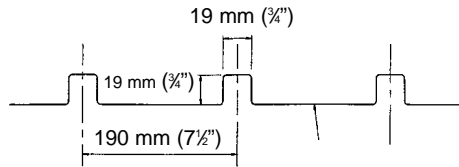
### **CSP Concrete-Lined Pipe**

The interior lining of the corrugated steel pipe is composed of an extremely dense, high strength concrete. The lining provides a superior wearing surface for extended structure life as well as a smooth interior for improved hydraulics.



### Spiral Rib Steel Pipe

Spiral rib pipe is manufactured from a continuous strip of metallic-coated steel passed through a forming line that forms the external ribs and prepares the edges. The formed section is then helically wound into pipe and the edges are joined by lock seaming. The finished product has the structural characteristics needed for installation and a smooth interior for improved hydraulics.



Spiral rib pipe installation.

### Double Wall (steel lined)

Double wall (steel lined) is a smooth interior corrugated steel pipe fabricated in full circular cross section with a smooth steel liner and helically corrugated shell integrally attached at helical lock seams from the end of each length of pipe. The smooth steel interior lining provides for improved hydraulics.



Lengths of pipe-arch are easily moved into position.

## PIPE MATERIALS, PROTECTIVE COATINGS, LININGS AND PAVINGS

### Sheets and Coils

Corrugated steel pipe is fabricated from steel sheets or coils conforming to national specifications. The base metal is mill coated with one of several metallic or non-metallic coatings or a combination thereof.

#### a) Metallic Coatings

Most CSP sheets and coils have a zinc coating. Other metallic coatings using aluminum or aluminum-zinc alloys are also available.

#### b) Non-Metallic Coatings

Sheets and coils are available mill coated with non-metallic coatings.

- 1) Various polymer films or liquids are applied to one or both sides of the metal.
- 2) Fibers are embedded in the molten metallic coating.

### Pipe

Fabricated pipe may be bituminous coated, bituminous coated and invert paved, and/or bituminous coated and fully paved. The pipe may be fully lined with bituminous material, concrete, or specially fabricated smooth with external ribs, or an integral smooth steel inner shell.



Placing coated CSP sewer section. Fabric sling protects pipe coating.

**Table 1.16 Material Description and Specifications**

Material	Description	Specifications	
		AASHTO	ASTM
Zinc Coated Sheets & Coils	Steel base metal* with 610 g/m <sup>2</sup> (2 oz/ft <sup>2</sup> ) zinc coating	M-218	A929M
Polymer Coated Sheets and Coils	Polymer coatings applied to sheets* and coils* 0.25 mm (0.010 in.) thickness each side	M-246	A742M
Fiber Bonded Coated Sheets	Steel base metal with zinc coating and fibers pressed into the zinc while molten to form fiber bonded coating	–	A885
Aluminum Coated Coils	Steel base metal* coated with 305 g/m <sup>2</sup> (1 oz/ft <sup>2</sup> ) of pure aluminum	M-274	A929M
Sewer and Drainage pipe	Corrugated pipe fabricated from any of the above sheets or coils. Pipe is fabricated by corrugating continuous coils into helical form with lockseam or welded seam, or by rolling annular corrugated mill sheets and riveting seams: 1. Galvanized corrugated steel pipe 2. Polymeric pre-coated sewer and drainage pipe 3. Fiber bonded impregnated corrugated steel pipe 4. Aluminized corrugated steel pipe 5. Structural plate pipe	M-36 M-245 – M-36 M-167	A760M A762M A760M A760M A761M
Asphalt Coated Steel Sewer Pipe	Corrugated steel pipe of any of the types shown above with a 1.3 mm (0.0050 in.), high purity asphalt cover	M-190	A849 A862
Invert Paved Steel Sewer Pipe	Corrugated steel pipe of any one of the types shown above with an asphalt pavement poured in the invert to cover the corrugation by 3.2 mm (1/8 in.)	M-190	A849 A862
Fully Lined Steel Sewer Pipe	Corrugated steel pipe of the types shown above: 1. With an internal asphalt lining centrifugally spun in place 2. Corrugated steel pipe with a single thickness of smooth sheet fabricated with helical ribs projected outward 3. With an internal concrete lining in place 4. Corrugated steel pipe with a smooth steel liner integrally formed with the corrugated shell	M-190 M-36 M-36 M-36	A849, A862 A760M A849, A979M A760M
Cold Applied Bituminous Coatings	Fibrated mastic or coal tar base coatings of various viscosities for field or shop coating of corrugated pipe or structural plate	M-243	A849
Gaskets and Sealants	1. Standard O-ring gaskets 2. Sponge neoprene sleeve gaskets 3. Gasketing strips, butyl or neoprene 4. Mastic sealant	– –	D1056 C361

**Notes:** \*Yield point – 230MPa (33 ksi) min.; tensile strength – 310MPa (45 ksi) min.; elongation (50 mm/ 2 in.) – 20% min.





CSP sewer designed for very wide trenches.

# Storm Drainage Planning

## CHAPTER 2

---

### INTRODUCTION

Rainfall exceeding the soil's capacity of infiltration and storage results in runoff. In undeveloped areas, such runoff will be accommodated by the natural streams and watercourses, but as development takes place, the natural hydrological balance is changed, resulting in greater runoff due to the increase in impervious surface areas.

In response to this, and to limit the inconvenience to the public, people have, during history, developed techniques for accommodating the increased runoff by constructing swales, ditches, culverts, sewers and canals. Over the years, these techniques have improved as more knowledge has been gained about the factors affecting storm water runoff (hydrology) and the conveyance (hydraulics) in pipes and open watercourses. Similarly, our ability to find more efficient ways of constructing storm drainage facilities also has increased.

The basic philosophy applied to the design of storm drainage facilities followed in the past and still widely practiced today, is to collect as much storm water runoff as possible and rapidly discharge it through a system of pipes to the nearest outlet.

Nevertheless, it has become apparent that in many instances we have ended up creating new problems, which now may become very difficult and expensive to solve.

The major problems that have been created can be summarized as follows:

- a) Higher peak flows in storm sewers and streams that require larger facilities at higher cost;
- b) Lowering of water tables, with a detrimental effect on existing vegetation, and in low-lying coastal areas, permitting salt water intrusion;
- c) Reduction in base flows in receiving streams affecting aquatic life;
- d) Excessive erosion of streams and sedimentation in lakes due to higher discharge velocities;
- e) Increased pollution of receiving streams and lakes due to industrial fallout on roofs, fertilizers from lawns and debris from streets and paved areas being conveyed directly to the streams;
- f) Damage due to flooding (runoff quantities) which had been experienced rarely, now occur much more frequently.

*Prior to development, most of this water could soak back into the earth; present practices often prevent it.*

Of major importance in the design of storm drainage facilities is the realization that all urban storm drainage systems are comprised of two separate and distinct systems, namely the *Minor System* and the *Major System*.

*The Minor System* (or "convenience" system) consists of carefully designed closed and open conduits and their appurtenances, with capacity to handle runoff from a storm expected to occur with a certain frequency and in a way that will cause relatively minor public inconvenience.

*The Major System* is the route followed by runoff waters when the minor system is inoperable or inadequate. The lack of a properly designed major system often leads to flooding, causing severe damage.

It is not economically feasible to enlarge the minor system to obviate the need for the major system. By careful attention during the initial planning stage, a major system can usually be incorporated at no additional cost, and it often permits substantial cost savings.

In recent years a philosophy has emerged which departs from the past practices, by attempting to follow the natural hydrological processes as much as possible. For instance, in urban areas where hydrologic abstractions (i.e. infiltration, depression storage, etc.) have been reduced or completely eliminated, facilities are designed to accommodate the abstractions lost through urbanization, permitting the runoff rates and volumes to remain close to those prior to development, or limited to an acceptable level.

The application of the philosophy has come to be known by the term *Storm Water Management*, which may be defined as follows: "Storm water management is the combined efforts of governing agencies providing policies and guidelines, and professions responsible for design and construction of storm drainage facilities, to control the effects of storm water so that the threat not only to life and property, but also to the environment as a whole, can be minimized."

Management techniques consist of methods such as:

- a) *Surface Infiltration*, where runoff is directed to pervious surfaces, (i.e. lawns, parks);
- b) *Ground Water Recharge*, disposal of storm water by subsurface infiltration drainage, particularly in areas with a substratum of high porosity;
- c) *Storm Water Detention*, temporary storage of excess runoff, with subsequent regulated release rate to the outlet.

Another term that has become synonymous with Storm Water Management is the term *Zero Increase in Storm Water Runoff*. This is the implementation of storm water management to limit storm water runoff to flows that occurred prior to development. This criteria may be applied to one frequency of occurrence or may be designed for a series of frequencies.



Lifting lugs are provided to protect the exterior coating on this CSP.



## CONCEPTUAL DESIGN

When designing the storm drainage system, the engineer should examine the site of the proposed development, both by visual inspection and through the aid of topographical maps to obtain a better understanding of the natural drainage patterns.

Every effort should be made to coordinate proposed drainage facilities, such as storm sewers and artificial channels with natural waterways, in such a way that will be both aesthetically pleasing and functional.

To achieve these objectives, it must be realized that urban drainage is always composed of two separate and distinctive systems, one to handle low intensity storms (the “minor” system) and another (the “major” system) that comes into use when the first system has insufficient capacity or becomes inoperable due to temporary blockage. When both systems are properly designed, they will provide a high level of protection against flooding, even during major storms, while usually being more economical than the conventional methods prevalent in many urban areas.

### The Minor System

The minor system consists of carefully designed closed and open conduits and their appurtenances, with the capacity to handle runoff from a storm expected to occur once within a one-year to five-year period and in a way that will cause relatively minor public inconvenience.

The criteria recommended for this system are as follows:

- a) Level of Service – One- or two-year rainfall intensity for normal residential areas, increasing up to five or ten years for major traffic arteries and commercial districts.
- b) Design to recognize surcharging to road surfaces, permitting the hydraulic gradient to follow roadways, resulting in a more economic system.
- c) No connections other than to catchbasins and other inlet structures.
- d) Foundation drains must not be connected by gravity to storm sewers, except where the sewers are sufficiently deep or large to prevent hydrostatic pressure in basements during surcharge conditions.
- e) Minimum depth of cover to be a function of external loading, but the spring-line must always be below frost depth.
- f) Downspouts should, wherever possible, be discharged to the ground, utilizing suitable splash pads.

### The Major System

The major system is the route followed by runoff waters when the minor system is inoperable or inadequate. It is usually expensive to eliminate any need for a major system. By careful attention from the initial planning stage, a major system can usually be incorporated at no additional cost and will often result in substantial savings in the minor system as well, i.e., greater protection at less cost. The criteria recommended for this system are as follows:

- a) Level of Protection–100-year frequency desirable, 25-year minimum.
- b) Continuous road grades or overflow easements to open watercourses.
- c) No damage may be caused to private structures due to flooding.
- d) Surface flows on streets to be kept within reasonable limits.

## METHODS TO REDUCE QUANTITY OF RUNOFF AND MINIMIZE POLLUTION

If the storm water is permitted to follow its natural hydrological process, it will inevitably result in a reduction in the quantity of storm water runoff and a reduction of pollution loading in the receiving watercourses. Storm water should be directed into the soil, preferably to the same extent as prior to development, and maybe to an even greater extent. By allowing storm water to infiltrate back into the soil, it will not only reduce the quantity of runoff and recharge the water table, but the filtering properties of the soil will improve the water quality.

Whatever amount cannot be so accommodated at the point of rainfall should be detained in nearby locations for a controlled outlet to the receiving streams, with peak flows approaching the pre-development peak flows. There are a variety of methods in common use today that can effectively control peak runoff rates, while at the same time, improving quality. The following Table 2.1 lists such methods along with their effectiveness.



Long lengths with fewer joints can lower the effective “n” value.

**Table 2.1 Measures for Reducing Quantity of Runoff and Minimizing Pollution**

Measure	Reduce Volume of Runoff	Reduce Peak Rate of Runoff	Improvements to Runoff Water Quality	Applicability				
				Residential	Institutional	Commercial	Industrial	Highways
Roof Water to Grassed Surfaces	X	X	X	X				
Contour Grading	X	X		X				
Porous Pavement								
— Interlocking Stones	X	X		X	X	X	X	
— Gravelled Surfaces	X	X		X	X	X	X	
— Porous Asphalt	X	X		X	X	X	X	X
Grassed Ditches	X	X	X	X	X	X	X	X
Infiltration Basins	X	X	X	X	X	X	X	X
Blue-Green Storage		X		X	X	X	X	
Ponding on Flat Roofs		X			X	X	X	
Ponding on Roadways		X		X			X	
Ponding on Parking Lots		X			X	X	X	
Detention Ponds (Dry Pond)		X	X	X	X	X	X	X
Retention Ponds No Freeboard			X					
Retention Ponds With Freeboard		X	X	X	X	X	X	
Subsurface Disposal								
— Perforated Storm Sewer	X	X	X	X	X	X	X	X
— Infiltration Trenches	X	X	X	X	X	X	X	X
— Dry Wells	X	X	X	X	X	X	X	X
Subsurface Detention		X	X	X	X	X	X	X

### Surface Infiltration

One method of reducing runoff is to make maximum use of the pervious surfaces in lawns, green belts and parklands. By discharging roof water onto lawns, a large percentage of the roof runoff may be absorbed into the soil. For minor storm events, the designer may use the same runoff factors for roofs as for sodded areas. In such cases, this will generally mean a reduction in runoff of about 60-70 percent for the roof area. To prevent the downspout discharge from reaching the foundation drains, it is very important that splash pads be placed below the downspouts. This will prevent erosion and permit water to flow freely away from the foundation wall. The downspouts should, wherever practical, be placed in a location that will avoid problems during freezing temperatures, such as icing of driveways, and preferably where the runoff can reach grassed areas. This will also increase the time of concentration, resulting in further reduction in runoff. Additional infiltration and delay in runoff can often be achieved by means of contour grading of the site.

Special "recharge basins" can also be included as part of the drainage system in areas where the percolation rate is fair to high. They are similar to detention basins, but permit recharging of groundwater while detaining only the excess runoff.



Twin 180 m (590 ft) long smooth line, 2400 mm (96 in.) diameter provide cooling water at the Crist Steam Generating Plant of Gulf Power Company.

### Effects on Water Quality

The concepts used for detention and reduction of storm water runoff not only regulate the amounts and rate of runoff of storm water, but also are an important factor in reducing pollution. Sedimentation basins, underground recharge systems and detention facilities all have treatment capabilities. Runoff from roofs, directed over grassed surfaces rather than being piped directly to a storm sewer, will receive a substantial reduction in pollution through its travel over-land or through percolation into the soil. Perforated storm sewers with a properly designed filter material will permit initial runoff (the “first flush”), which contains most of the pollutants, to be temporarily stored in the underground system for gradual percolation into the soil. The voids in the stone filter material will permit treatment of pollutants somewhat similar to the action of a septic tile bed.

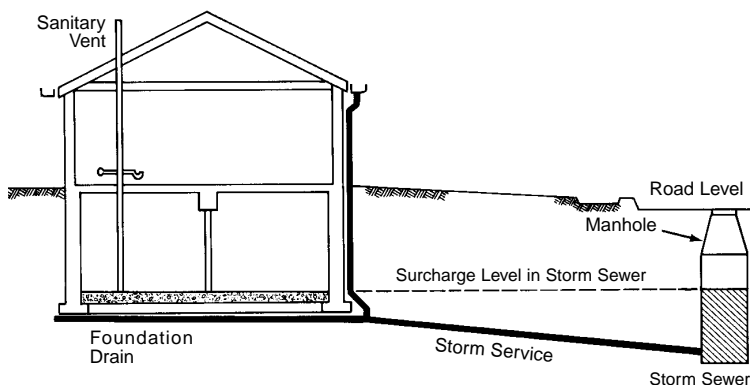
### FOUNDATION DRAINS

In the past, most foundation drains were often connected to the sanitary sewers, where such were available; otherwise they were served by sump pumps. With the growing demand for increased sewage treatment capacities, it became logical to eliminate as much extraneous flow from the sanitary sewers as possible, and some municipalities started to prohibit foundation drain connections to sanitary sewers, preferring to connect them to the storm sewer. The additional expense of extending storm sewers to serve the full length of all streets rather than to catch basins only, and the extra depths needed to connect the foundation drains by gravity, were considered to be worth the cost.

Only later did we realize that a problem was created, much larger than the one we were trying to solve.

Since it is not economically feasible to size storm sewers to accommodate every possible runoff eventuality, times occurred when the storm sewer backed up to levels above the basement floors, with the result that storm water flowed into foundation drains and caused the condition it was supposed to prevent (see Figure 2.1).

The condition became considerably worse where roof-water leaders were also connected to the same outlet pipe as the foundation drains. In addition to the high cost involved, this method resulted in many flooded basements as well as exten-



**Figure 2.1** Foundation drain and downspout connected to storm sewer by gravity.

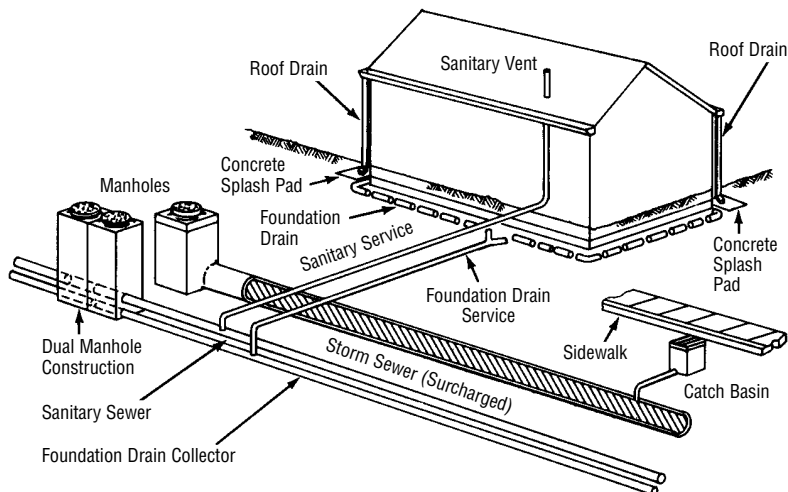
sive structural damage to basements from the hydrostatic pressure exerted. Standard methods of construction cannot withstand a hydrostatic pressure of more than 150 to 300 mm (6 to 12 in.) before damage takes place.

Some areas experiencing this problem have preferred to increase the sewer design criteria from a two-year to a five- or even ten-year rainfall frequency. This conflicts with the present emphasis of reducing runoff, but even if it did not, many indeterminable factors not yet recognized in storm drainage design will make it impossible for the designer to predict with any degree of accuracy what storm frequency the system will actually be able to handle before hydrostatic pressure will occur on basements. Due to the variations in storm patterns and runoff conditions, a system designed for a ten-year frequency may, in some areas, be able to accommodate a storm of much higher intensity, and in other locations considerably less. With a different storm pattern the condition could be reversed.

If foundation drains are connected by gravity to storm sewers of less capacity and the hydraulic grade line exceeds the basement elevation, protection against flooding of basements cannot be obtained.

Another possibility could be sump pump installations which can discharge to the ground or to a storm sewer. This would transfer the problem to the individual homeowner, who may not be too pleased with a device that, as a result of mechanical or power failure, may cause flooding in his basement. The resulting damage, however, would not cause structural failure to the basement, as pressure equalizes inside and outside. Although the inflowing water would be relatively clean storm water rather than sewage, this solution does not seem very desirable when projected for areas expecting a large urban growth.

An alternative solution is a separate foundation drain collector, such as a third pipe installed in the same trench as the sanitary sewer but with connection to foundation drains only (see Figure 2.2). The method has several advantages and, for many new areas, it may be the best solution. A foundation drain collector will:



**Figure 2.2** Foundation drain connected to foundation drain collector by gravity.

- a) eliminate the probability of hydrostatic pressure on basements due to surcharged sewers;
- b) eliminate infiltration into sanitary sewers from foundation drains;
- c) permit shallow storm sewers, design for lower rainfall intensity, and could reduce length of storm sewers, resulting in cost savings for the storm sewer system; and
- d) permit positive design of both the minor and major storm drainage systems.

Since it does require an outlet with free discharge even during severe thunderstorm conditions, it may not be practical in all areas, particularly within built-up areas where storm sewer outlets have already been provided.

### **Environmental Considerations of Runoff Waters**

This section addresses environmental and legal constraints that should be considered in planning and designing underground disposal systems for storm water runoff.

Various sources of data do attempt to define the character and concentrations of pollutants generated from urban areas.<sup>1, 2, 3</sup> An extensive database was gathered for the Water Planning Division of the U.S. Environmental Protection Agency (EPA)<sup>4</sup>. The EPA established the National Urban Runoff Program (N.U.R.P.) in 1978. As part of this program, average concentrations for various pollutants were established Act of 1987. Section 402 now requires the EPA to promulgate regulations establishing permit application requirements for certain storm water discharges and separate storm sewers (Table 2.2). The average concentration or median event meant concentrations were based on data from 28 projects throughout the United States.



Standard CSP structural designs permit unrestricted trench width.

**Table 2.2 Median EMCs for All Sites by Land Use Category**

Pollutant		Residential		Mixed		Commercial		Open/Non-urban	
		Median	CV	Median	CV	Median	CV	Median	CV
Biochemical Oxygen Demand	mg/l	10.0	0.41	7.8	0.52	9.3	0.31	–	–
Chemical Oxygen Demand	mg/l	73	0.55	65	0.58	57	0.39	40	0.78
Total Suspended Solids	mg/l	101	0.96	67	1.14	69	0.85	70	2.92
Total Lead	µg/l	144	0.75	114	1.35	104	0.68	30	1.52
Total Copper	µg/l	33	0.99	27	1.32	29	0.81	–	–
Total Zinc	µg/l	135	0.84	154	0.78	226	1.07	195	0.66
Total Kjeldahl Nitrogen	µg/l	1900	0.73	1288	0.50	1179	0.43	965	1.00
Nitrite + Nitrate	µg/l	736	0.83	558	0.67	572	0.48	543	0.91
Total Phosphorus	µg/l	383	0.69	263	0.75	201	0.67	121	1.66
Soluble Phosphorus	µg/l	143	0.46	56	0.75	80	0.71	26	2.11

**Legend:** mg/l = milligrams per liter  
µg/l = micro grams per liter  
CV = coefficient of variation



Perspective on the possible impacts of subsurface disposal of storm water runoff can be gained from information available on the land treatment of municipal wastewater. Design guidelines for the use of these systems are defined in detail in the "Process Design Manual for Land Treatment of Municipal Wastewater," published jointly by the EPA, U.S. Army Corps of Engineers, and U.S. Department of Agriculture.<sup>5</sup>

The main stimulus to elimination of storm sewer discharge into surface waters has been concern over its impact on public health and aquatic biological communities. As combined sanitary storm sewer systems have been identified and direct discharges reduced, attention has focused on the quality of stormwater

To effectively address the storm water issue, U.S. Congress amended section 402 of the Clean Water Act in the course of enacting the Water Quality Act of 1987. Section 402 now requires the EPA to promulgate regulations establishing permit application requirements for certain storm water discharges and separate storm sewer systems.

The rules develop a framework for National Pollutant Discharge Elimination System (N.P.D.E.S.) permits for storm water discharges associated with industrial activity; discharges from large municipal separate storm sewer systems (systems serving a population of 250,000 or more); and discharges from medium municipal separate storm sewer systems (systems serving a population of 100,000 or more, but less than 250,000).<sup>6</sup>

**Table 2.3 EPA Regulations on Interim Primary Drinking Water Standards, 1975<sup>7</sup>**

Constituent or Characteristic	Value	Reason For Standard
Physical		
Turbidity, mg/l	12	Aesthetic
Chemical, mg/l		
Arsenic	0.05	Health
Barium	1.0	Health
Cadmium	0.01	Health
Chromium	0.05	Health
Fluoride	1.4-2.43	Health
Lead	0.05	Health
Mercury	0.002	Health
Nitrate as N	10	Health
Selenium	0.01	Health
Silver	0.05	Cosmetic
Bacteriological		
Total coliform, per 100 mg	1	Disease
Pesticides, mg/l		
Endrin	0.0002	Health
Lindane	0.004	Health
Methoxychlor	0.1	Health
Toxaphene	0.005	Health
2, 4-D	0.1	Health
2, 4, 5-TP	0.01	Health

- Notes:**
1. The latest revisions to the constituents and concentrations should be used.
  2. Five mg/l of suspended solids may be substituted if it can be demonstrated that it does not interfere with disinfection.
  3. Dependent on temperature; higher limits for lower temperatures.

The general reference for ground water quality is drinking water standards since many near-surface or water table aquifers constitute the main source of public water supplies. For areas affected by saltwater intrusion or locations with naturally poor quality ground water, disposal of poor quality surficial storm water is not a serious concern. The EPA-proposed drinking water standards are listed in Table 2.3.

If ground water contaminants are substantially higher in the area of concern than any of the current listed standards for drinking water quality, future use as a public water supply is doubtful and the subsurface disposal permitting process should be greatly simplified.

Most State Health Departments prohibit direct discharge of storm water runoff into underground aquifers. Recharge systems are not utilized in some states because these requirements place restrictions on storm water infiltration systems. Under water pollution law in Ohio, for example, offenders can be charged with polluting ground water but those charges must be made and proven in a court of law.<sup>8</sup>

Some northern states use large quantities of road de-icing salts during winter months. These states have tended to refrain from use of storm water recharge systems fearing possible contamination of ground water. To prevent ground water pollution, some agencies in California require a 3 m (10 ft) aquifer clearance for drainage well construction.<sup>9</sup> Drainage wells are readily capable of polluting ground water supplies, and local regulatory agencies should be consulted concerning the amount of aquifer clearance required for a specific project.

### Ground Water Quality Process

Chemical analyzes of water commonly report constituent concentrations as "total." This designation implies that nitrogen, for example, is a total of dissolved and particulate phases. The principle dissolved nitrogen species are ammonia, soluble organic nitrogen, nitrite, and nitrate. The particulate can be either absorbed nitrogen, organic matter containing nitrogen, or insoluble mineralogic phases with nitrogen in the lattice.

The particulate in the various elements are also represented in the suspended sediments. The distinction is sometimes important as soils and interstitial areas of



Structural plate storm sewer encloses stream in an urban area.

some aquifers can filter out particulate or suspended solids thereby reducing the impact of the various pollutants on the ground water. This is particularly important in the case of bacteria.

The natural filtration of runoff water by the soil removes most harmful substances before they can reach the water-bearing aquifer. Nearly all pathogenic bacteria and many chemicals are filtered within 1-3 m (3-10 ft) during vertical percolation, and within 15-60 m (50-200 ft) of lateral water movement in some soil formations.<sup>10</sup>

Tests made by the U.S. Department of Agriculture for the Fresno Metropolitan Flood Control District indicated heavy metals such as lead, zinc, and copper were present in the upper few centimeters of storm water infiltration basin floors. Generally after 10 to 15 years of storm water collection, this layer may require removal or other treatment where a buildup of concentrations of these elements has occurred. The particular locations tested by USDA had soils with a relatively high clay content.<sup>8</sup> Layers of fine sands, silts, and other moderately permeable soils also very definitely improve the quality of storm water. This concept underlies the practice of disposing of domestic sewage in septic tanks with leach lines or pits, and the land disposal techniques.

One of the major traffic-related contaminants is lead. Although lead is primarily exhausted as particulate matter, it is fairly soluble. Ionic lead tends to precipitate in the soil as lead sulfate and remains relatively immobile due to low solubility.<sup>11</sup> Ionic forms can also be tied up by soil micro-organisms, precipitation with other anions, ion exchange with clay minerals, absorption by organic matter, or uptake by plants. Once ionic lead reaches the ground, watertable, precipitation, ion exchange, or absorption can still reduce the available lead. Surface and ground water quality samples collected near a major highway interchange in Miami, Florida, revealed that lead concentrations were very low.<sup>12</sup> The interaction of lead with the high bicarbonate probably caused precipitation in the surface water borrow pond. Sediment concentrations were relatively high.

If impure water is allowed to enter directly into coarse gravel or open joints in rocks, the impurities may enter into and contaminate adjacent ground waters. Sites that are underlain with highly permeable strata, or cracked and jointed rocks have the best capabilities for rapid disposal of surface waters. Unless adequate arrangements are made to treat contaminated water or to filter impurities, infiltration systems may degrade the ground water quality. Faults and intrusions should always



This twin CSP diversion is more than a kilometer long.

be evaluated for their effect on ground water occurrence, on quality, and on direction of movement. If the underlying rock strata is fractured or crevassed like limestone, storm water may be diverted directly to the ground water, thereby receiving less treatment than percolation through soil layers.

Breeding and Dawson<sup>13</sup> tell about a system of 127 recharge wells used by the City of Roanoke, Virginia, to dispose of storm runoff from newly developing industrial and residential areas. Several major faults exist in the underlying bedrock. These faults play a significant role in the effectiveness of the drainage wells, and also in the movement of ground water. The authors also indicate that these direct conduits to ground water have caused quality degradation in one area; however, "ground water users in adjacent Roanoke County have not experienced quality problems that could be connected to this means of storm water disposal."

The case cited illustrates the possibility of ground water contamination in areas where fractured and highly permeable rock layers exist, providing conduits for widespread movement of contaminants. It is, therefore, important in the planning stages of a large subsurface storm water disposal project to identify the underlying soil strata in terms of its hydraulic, physical, and chemical characteristics. Pertinent *physical characteristics* include texture, structure, and soil depth. Important *hydraulic characteristics* are infiltration rate, and permeability. *Chemical characteristics* that may be important include pH, cation-exchange capacity, organic content, and the absorption and filtration capabilities for various inorganic ions.

If detailed ground water quality analyzes are available, it is possible to compute the solution-mineral equilibrium.<sup>14</sup> This approach does not guarantee that an anticipated chemical reaction will occur but does indicate how many ionic species should behave. The items referring to physical and hydraulic characteristics are addressed to some extent in other chapters of this manual. Further discussion of the chemical characteristics of soils is beyond the scope of this manual. Definitive information on this subject can be obtained by consulting appropriate references, for example, Grim,<sup>15</sup> or other textbooks on the subject. The importance of proper identification of the hydraulic characteristics of the rock strata has been noted previously.



A view of the 18 lines of 1200 mm (48 in.) diameter fully perforated corrugated steel pipe used as a recharge system.

## Ground Water Monitoring

Environmental laws and regulations now in force require the monitoring of ground water where adverse effects to its quality may result from disposal and storage of solid and liquid wastes. Monitoring systems have not, as yet, been required for ground water recharge utilizing storm water.

## REFERENCES

1. Mattraw, H.C. and Sherwood, C.B., "The Quality of Storm Water Runoff from a Residential Area, Broward County, Florida," U.S. Geological Survey, Journal of Research, 1977.
2. Gupta, M., Agnew, R., Meinholz, T., and Lord, B., "Effects and Evaluation of Water Quality Resulting from Highway Development and Operation," Report No. DOT-FH-11-8600, Federal Highway Administration, Office of Research and Development, Washington, D.C., Oct. 1977.
3. Moe, R., Bullin, J., Polasek, Miculka, J. and Loughheed, M., Jr., "Characteristics of Highway Runoff in Texas," Report No. DOT-FH-11-8608, Federal Highway Administration, Office of Research and Development, Washington, D.C., Nov. 1977.
4. "Final Report of the Nationwide Urban Runoff Program," U.S. Environmental Protection Agency, Water Planning Division, Washington, D.C., Dec. 1983.
5. *Process Design Manual for Land Treatment of Municipal Wastewater*, U.S. Environmental Protection Agency, Environmental Research Information Center, Office of Water Programs Operation, Jointly sponsored by U.S. EPA, U.S. Army Corps of Engineers and U.S. Department of Agriculture, Oct. 1977.
6. Notice of Proposed Rulemaking (N.P.R.M) For National Pollutant Discharge Elimination System (N.P.D.E.S.) Permit Application Requirements For Storm water Discharges. U.S. Environmental Protection Agency, Office of Enforcement And Permits, Nov. 1988.
7. National Interim Primary Drinking Water Regulations, U.S. Environmental Protection Agency. 40 CFR 141, Dec. 24, 1975.
8. Response to Task Force 17 Questionnaire, "Infiltration Drainage Design for Highway Facilities," Fresno Metropolitan Flood Control District, Apr. 27, 1977.
9. Smith, T.W., Peter R.R., Smith, R.E., Shirley, E.C., Infiltration Drainage of Highway Surface Water, Transportation Laboratory, California Department of Transportation, Research Report 6328201, Aug. 1969.
10. Johnson, E.E., Inc., *Groundwater and Wells*, St. Paul, Minn. 1966, pp. 402-411.
11. Olson, K.W., Skogerboe, R.K., Identification of Soil Lead Compounds from Automotive Sources, Environmental Science and Technology, Vol. 9, No. 3, Mar. 1975, pp. 227-230.
12. Beaven, T.R., and McPherson, B.F., "Water Quality in Borrow Ponds near a Major Dade County, Florida Highway Interchange, October-November 1977", U.S. Geological Survey Open File Report, in Review, 1978.
13. Breeding, N.K., Jr., and Dawson, J.W., "Recharge Wells," Water and Sewage Works, Feb. 1977.
14. Kharaka, V.K., and Barnes, I., SOLM-NEQ: Solution-Mineral Equilibrium Computations, U.S. Geological Survey Computer Contribution, PB-215 899, Feb. 1973.
15. Grim, R.E., *Clay Mineralogy*, McGraw-Hill Inc., 1968.

## BIBLIOGRAPHY

- Amy, G., Pitt, R., Singh, R., Bradford, W.L., and La Graff, M.B., *Water Quality Management Planning for Urban Runoff*, Report 44019-75-004, U.S. Environmental Protection Agency, December 1974.
- Edwards, M.D., *Status of the National Water Data Exchange (NAWDEX - September 1977)*, U.S. Geological Survey Open File Report 78-154, 1978.



7 m (24 ft) diameter steel sewer being installed in wet conditions.

## CHAPTER 3 Hydrology

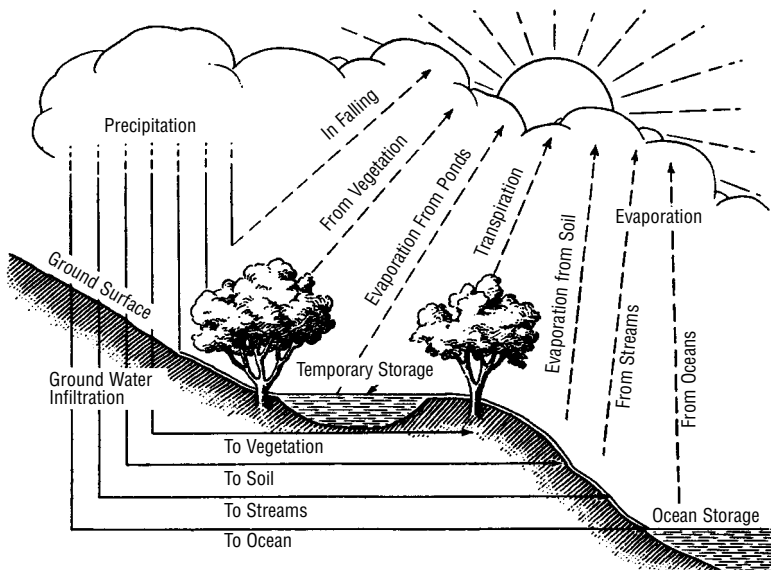
### INTRODUCTION

The hydrologic cycle is a continuous process whereby water is transported from ocean and land surfaces to the atmosphere from which it falls again in the form of precipitation. There are many inter-related phenomena involved in this process and these are often depicted in a simplistic form as shown in Figure 3.1. Different specialist interests, such as meteorologists, oceanographers or agronomists, focus on different components of the cycle, but from the point of view of the drainage engineer, the relevant part of the cycle can be represented in idealistic fashion by the block diagram of Figure 3.2.

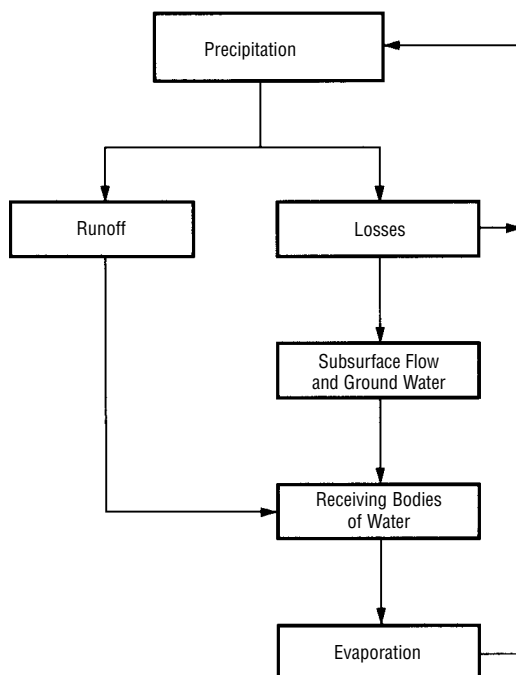
The effect of urbanization on the environment is to complicate that part of the hydrologic cycle that is affected by the modification of natural drainage paths, impounding of water, division of storm water and the implementation of storm water management techniques.

The objective of this chapter is to introduce the drainage engineer to different methods for estimating those components of the hydrologic cycle which affect design decisions—from precipitation to runoff. Emphasis is placed on the description of alternative methods for analyzing or simulating the rainfall-runoff process, particularly where these apply to computer models. This should help the user of these models in determining appropriate data and interpreting the results, thereby lessening the “black box” impression with which users are often faced.

Inevitably, it is necessary to describe many of these processes in mathematical terms. Every effort has been made to keep the presentation simple, but some fundamental knowledge of hydrology has been assumed.



**Figure 3.1** Hydrologic cycle - where water comes from and where it goes. From M.G. Spangler's "Soil Engineering"<sup>1</sup>



**Figure 3.2** Block diagram—Hydrologic Cycle.

## ESTIMATION OF RAINFALL

The initial data required for drainage design are descriptions of the rainfall. In most cases this will be a single event storm, i.e., a period of significant and continuous rainfall preceded and followed by a reasonable length of time during which no rainfall occurs. Continuous rainfall records extending many days or weeks may sometimes be used for the simulation of a system, particularly where the quality rather than the quantity of runoff water is of concern.

The rainfall event may be either historic, taken from recorded events or idealized. The main parameters of interest are the total amount (or depth) of precipitation ( $P_{tot}$ ), the duration of the storm ( $t_d$ ) and the distribution of the rainfall intensity ( $i$ ) throughout the storm event. The frequency of occurrence ( $N$ ) of a storm is usually expressed in years and is an estimate based on statistical records of the long-term average time interval, which is expected to elapse between successive occurrences of two storms of a particular severity (e.g., depth  $P_{tot}$  in a given time  $t_d$ ). The word “expected” is emphasized because there is absolutely no certainty that after a 25-year storm has occurred, a storm of equal or greater severity will not occur for another 25 years. This fact, while statistically true, is often difficult to convey to residents of an area.



### Rainfall Intensity—Duration Frequency Curves

Rainfall intensity-duration frequency curves are derived from the statistical analysis of rainfall records compiled over a number of years. Each curve represents the intensity-time relationship for a certain return frequency, from a series of storms. These curves are then said to represent storms of a specific return frequency.

The intensity, or the rate, of rainfall is usually expressed in depth per unit time with the highest intensities occurring over short time intervals and progressively decreasing as the time intervals increase. The greater intensity of the storm, the lesser their recurrence frequency; thus the highest intensity for a specific duration for  $N$  years of records is called the  $N$  year storm, with a frequency of once in  $N$  years.

The curves may be in the graphical form as the example shown in Figure 3.3, or may be represented by individual equations that express the time intensity relationships for specific frequencies, in the form:

$$i = \frac{a}{(t + c)^b}$$

where:  $i$  = intensity mm/hr (in./hr)

$t$  = time in minutes

$a, b, c$  = constants developed for each IDF curve

The fitting of rainfall data to the equation may be obtained by either graphical or least square methods.<sup>2</sup>

It should be noted that the IDF curves do not represent a rainfall pattern, but are the distribution of the highest intensities over time durations for a storm of  $N$  frequency.

The rainfall intensity-duration curves are readily available from governmental agencies, local municipalities and towns, and as such are widely used in the designing of storm drainage facilities and flood flow analysis.

### Rainfall Hyetographs

The previous section discussed the dependence of the average rainfall intensity of a storm on various factors. Of great importance from historical rainfall events is the way in which the precipitation is distributed in time over the duration of the storm. This can be described using a rainfall hyetograph, which is a graphical representation of the variation of rainfall intensity with time. Rainfall hyetographs can be obtained (usually in tabular rather than graphical form) from weather stations that have suitable records of historical rainfall events. Figure 3.4 shows a typical example.

Conventionally, rainfall intensity is plotted in the form of a bar graph. It is thus implicitly assumed that the rainfall intensity remains constant over the timestep used to describe the hyetograph. Obviously this approximation becomes a truer representation of reality as the timestep gets smaller. However, very small timesteps may require very large amounts of data to represent a storm and can increase the computational cost of simulation considerably. At the other extreme, it is essential that the timestep not be too large, especially for short duration events or very small catchments, otherwise peak values of both rainfall and runoff can be “smeared” with consequent loss of accuracy. When using a computer model, this point should be kept in mind since it is usual to employ the same timestep for

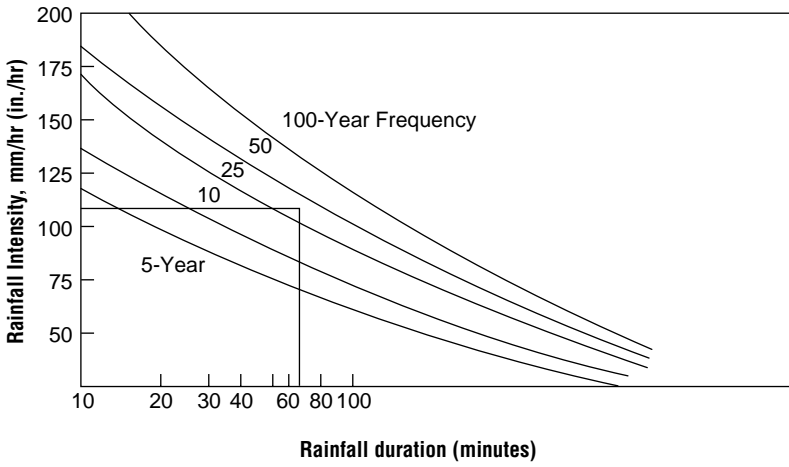


Figure 3.3 Rainfall for various storm frequencies vs. rainfall duration.

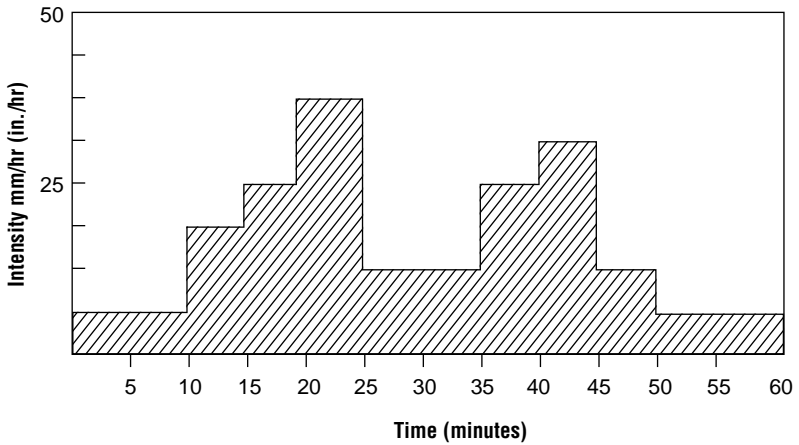


Figure 3.4 Rainfall hyetograph.

both the description of the rainfall hyetograph and the computation of the runoff hyetograph. Choice of timestep is therefore influenced by:

- a) Accuracy of rainfall-runoff representation;
- b) Discretization of the available data;
- c) Size of the watershed; and
- d) Computational storage and cost.

### Synthetic Rainfall Hyetographs

An artificial or idealized hyetograph may be required for a number of reasons, two of which are noted here.

- a) The historic rainfall data may not be available for the location or the return frequency desired.
- b) It may be desirable to standardize the design storm to be used within a region in order that comparisons of results from various studies may be made.

The time distribution of the selected design hyetograph will significantly affect the timing and magnitude of the peak runoff. Care should therefore be taken in selecting a design storm to ensure that it is representative of the rainfall patterns in the area under study. In many cases, depending upon the size of the watershed and degree of urbanization, it may be necessary to use several different rainfall hyetographs to determine the sensitivity of the results to the different design storms. For example, when runoff from pervious areas is significant, it will be found that late peaking storms produce higher peak runoff than early peaking storms of the same total depth as the latter tend to be reduced in severity by the initially high infiltration capacity of the ground.

Selection of the storm duration will also influence the hydrograph characteristics. The Soil Conservation Service Handbook<sup>3</sup> recommends that a six-hour storm duration be used for watersheds with a time of concentration less than or equal to six hours. For watersheds where the time of concentration exceeds six hours, the storm duration should equal the time of concentration.

A number of different synthetic hyetographs are described in the following sections. These include:

- a) Uniform rainfall as in the rational method;
- b) The Chicago hyetograph;
- c) The SCS design storms; and
- d) Huff's storm distribution patterns.

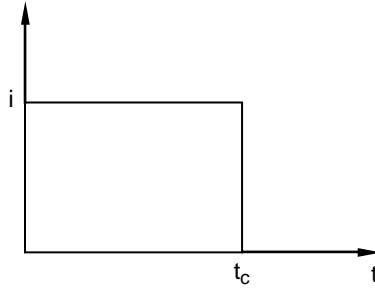
### Uniform Rainfall

The simplest possible design storm is to assume that the intensity is uniformly distributed throughout the storm duration. Thus

$$i = i_{ave} = \frac{P_{tot}}{t_d}$$

This simplified approximation is used in the rational method with the further assumption that the storm duration is equal to the time of concentration of the catchment (see Figure 3.5). Use of a rectangular rainfall distribution is seldom justified or acceptable nowadays, except for first cut or "back-of-the-envelope"

estimates. It can, however, have some use in explaining or visualizing rainfall runoff processes since any hyetograph may be considered as a series of such uniform, short duration pulses of rainfall.



**Figure 3.5** Uniform rainfall.

### The Chicago Hyetograph

The Chicago hyetograph<sup>4</sup> is assumed to have a time distribution such that if a series of ever increasing “time-slices” were analyzed around the peak rainfall, the average intensity for each “slice” would lie on a single curve of the IDF diagram. It implies that the Chicago design storm displays statistical properties that are consistent with the statistics of the IDF curve. The synthesis of the Chicago hyetograph, therefore, starts with the parameters of an IDF curve together with a parameter ( $r$ ), which defines the fraction of the storm duration that occurs before the peak rainfall intensity. The value of  $r$  is derived from the analysis of actual rainfall events and is generally in the range of 0.3 – 0.5.

The continuous curves of the hyetograph in Figure 3.6 can be computed in terms of the times before ( $t_b$ ) or after ( $t_a$ ) the peak intensity by the two equations below.

a) After the peak

$$i_a = \frac{a \left[ (1 - b) \frac{t_a}{1 - r} + c \right]}{\left( \frac{t_a}{1 - r} + c \right)^{1 + b}}$$

b) Before the peak

$$i_b = \frac{a \left[ (1 - b) \frac{t_b}{r} + c \right]}{\left( \frac{t_b}{r} + c \right)^{1 + b}}$$

where:  $t_a$  = time after peak  
 $t_b$  = time before peak  
 $r$  = ratio of time before the peak occurs to the total duration time

The Chicago storm is commonly used for small to medium watersheds (0.25 km<sup>2</sup> to 25 km<sup>2</sup> or 0.1 to 10 mi.<sup>2</sup>) for both rural or urbanized conditions. Typical storm durations are in the range of 1.0 to 4.0 hours. It has been found that peak runoff flows computed using a Chicago design storm are higher than those obtained using other synthetic or historic storms. This is due to the Chicago storm attempts to model the statistics of a large collection of real storms and thus tends to present an unrealistically extreme distribution. Another point to note is that the resultant peak runoff may exhibit some sensitivity to the time step used; very small timesteps giving rise to slightly more peaked runoff hydrographs.

**The Huff Rainfall Distribution Curves**

Huff<sup>5</sup> analyzed the significant storms in 11 years of rainfall data recorded by the State of Illinois. The data were represented in non-dimensional form by expressing the accumulated depth of precipitation P<sub>t</sub> (i.e., at time t after the start of rainfall) as a fraction of the total storm depth P<sub>tot</sub> and plotting this ratio as a function of a nondimensional time t/t<sub>d</sub>.

The storms were grouped into four categories depending on whether the peak rainfall intensity fell in the 1st, 2nd, 3rd or 4th quarter (or quartile) of the storm duration. In each category, a family of curves was developed representing values exceeded in 90%, 80%, 70%, etc., of the storm events. Thus the average of all the storm events in a particular category (e.g., 1st quartile) is represented by the 50% exceedence curve. Table 3.1 shows the dimensionless coefficients for each quartile expressed at intervals of 5% of t<sub>d</sub>.

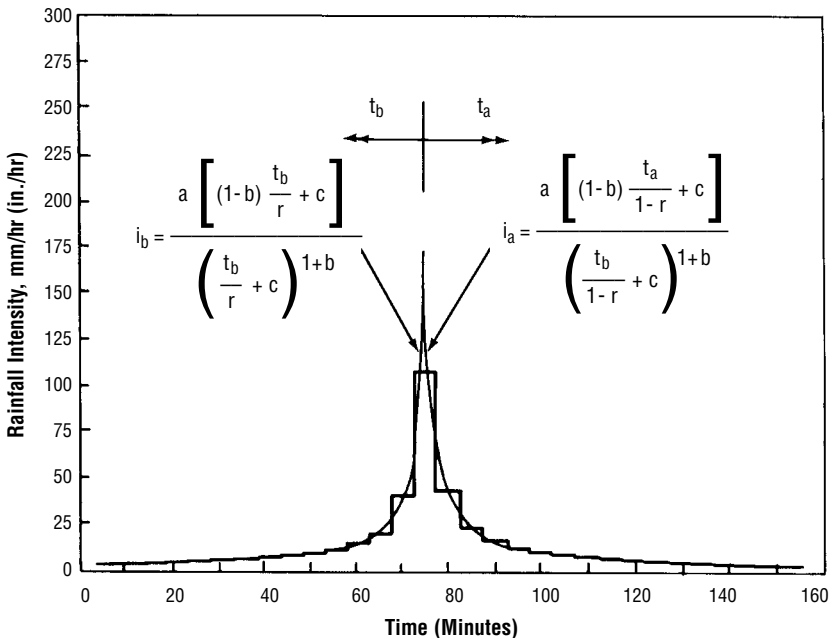


Figure 3.6 Chicago hyetograph.

The first quartile curve is generally associated with relatively short duration storms in which 62% of the precipitation depth occurs in the first quarter of the storm duration. The fourth quartile curve is normally used for longer duration storms in which the rainfall is more evenly distributed over the duration  $t_d$  and is often dominated by a series of rain showers or steady rain or a combination of both. The third quartile has been found to be suitable for storms on the Pacific seaboard.

The study area and storm duration for which the distributions were developed vary considerably, with  $t_d$  varying from 3 to 48 hours and the drainage basin area ranging from 25 to 1000 km<sup>2</sup> (10 to 400 mi.<sup>2</sup>). The distributions are most applicable to midwestern regions of North America and regions of similar rainfall climatology and physiography.

To use the Huff distribution, the user need only specify the total depth of rainfall  $P_{tot}$  the duration  $t_d$  and the desired quartile. The curve can then be scaled up to a dimensional mass curve and the intensities obtained by discretizing the mass curve for the specified timestep,  $t$ .

### SCS Storm Distributions

The U.S. Soil Conservation Service design storm was developed for various storm types, storm durations and regions in the United States<sup>3</sup>. The storm duration was initially selected to be 6 hours. Durations of up to 48 hours have, however, been developed. The rainfall distribution varies, based on duration and location. The 6-, 12- and 24-hour distributions for the SCS Type II storm are given in Table 3.2. This distribution is used in all regions of the United States and Canada with the exception of the Pacific coast.

**Table 3.1 Dimensionless Huff Storm Coefficients**

$t/t_d$	$P_t/P_{tot}$ For Quartile			
	1	2	3	4
0.00	0.000	0.000	0.000	0.000
0.05	0.063	0.015	0.020	0.020
0.10	0.178	0.031	0.040	0.040
0.15	0.333	0.070	0.072	0.055
0.20	0.500	0.125	0.100	0.070
0.25	0.620	0.208	0.122	0.085
0.30	0.705	0.305	0.140	0.100
0.35	0.760	0.420	0.155	0.115
0.40	0.798	0.525	0.180	0.135
0.45	0.830	0.630	0.215	0.155
0.50	0.855	0.725	0.280	0.185
0.55	0.880	0.805	0.395	0.215
0.60	0.898	0.860	0.535	0.245
0.65	0.915	0.900	0.690	0.290
0.70	0.930	0.930	0.790	0.350
0.75	0.944	0.948	0.875	0.435
0.80	0.958	0.962	0.935	0.545
0.85	0.971	0.974	0.965	0.740
0.90	0.983	0.985	0.985	0.920
0.95	0.994	0.993	0.995	0.975
1.00	1.000	1.000	1.000	1.000

The design storms were initially developed for large (25 km<sup>2</sup> or 10 mi.<sup>2</sup>) rural basins. However, both the longer duration (6- to 48-hour) and shorter 1-hour thunderstorm distributions have been used in urban areas and for smaller areas.

The longer duration storms tend to be used for sizing detention facilities while at the same time providing a reasonable peak flow for sizing the conveyance system.

**Estimation of Effective Rainfall**

Only a fraction of the precipitation that falls during a storm contributes to the overland flow or runoff from the catchment. The balance is diverted in various ways.

**Evaporation** In certain climates it is possible that some fraction of the rainfall evaporates before reaching the ground. Since rainfall is measured by gauges on the earth’s surface this subtraction is automatically taken into account in recorded storms and may be ignored by the drainage engineer.

**Interception** This fraction is trapped in vegetation or roof depressions and never reaches the catchment surface. It is eventually dissipated by evaporation.

**Infiltration** Rainfall that reaches a pervious area of the ground surface will initially be used to satisfy the capacity for infiltration in the upper layer of the soil. After even quite a short dry period, the infiltration

**Table 3.2 SCS Type II Rainfall Distribution for 3h, 6h, 12h and 24h Durations**

3 Hour			6 Hour			12 Hour			24 Hour		
Time end'g	F <sub>inc</sub> (%)	F <sub>cum</sub> (%)	Time end'g	F <sub>inc</sub> (%)	F <sub>cum</sub> (%)	Time end'g	F <sub>inc</sub> (%)	F <sub>cum</sub> (%)	Time end'g	F <sub>inc</sub> (%)	F <sub>cum</sub> (%)
0.5	4	4	0.5	2	2	0.5	1	1	2	2	2
			1.0	2	4	1.0	1	2			
			1.5	4	8	1.5	1	3			
			2.0	4	12	2.0	1	4			
			2.5	4	16	2.5	2	6			
1.0	8	12	2.0	4	12	3.0	2	8	8	4	12
			2.5	7	19	3.5	2	10			
			3.0	4	16	4.0	2	12			
			3.5	4	20	4.5	3	15			
			4.0	4	24	5.0	4	19			
1.5	58	70	3.0	51	70	5.5	6	25	12	51	70
			3.5	13	83	6.0	45	70			
			4.0	6	89	6.5	9	79			
			4.5	4	93	7.0	4	83			
			5.0	3	96	7.5	3	86			
2.0	19	89	4.0	6	89	8.0	3	89	16	6	89
			4.5	4	93	8.5	2	91			
			5.0	3	96	9.0	2	93			
			5.5	2	98	9.5	2	95			
			6.0	2	100	10.0	1	96			
2.5	7	96	5.0	3	96	10.5	1	97	20	3	96
			5.5	2	98	11.0	1	98			
			6.0	2	100	11.5	1	99			
			6.5	1	100	12.0	1	100			
			7.0	1	100						
3.0	4	100	6.0	2	100				24	2	100
			6.5	1	100						
			7.0	1	100						

capacity can be quite large (e.g., 100 mm/hr) but this gradually diminishes after the start of rainfall as the storage capacity of the ground is saturated. The infiltrated water will either:

- a) Evaporate directly by capillary rise;
- b) Evapotranspire through the root system of vegetal cover;
- c) Move laterally through the soil in the form of interflow toward a lake or stream; or,
- d) Penetrate to deeper levels to recharge the ground water.

Surface Depression Storage If the intensity of the rainfall reaching the ground exceeds the infiltration capacity of the ground, the excess will begin to fill the interstices and small depressions on the ground surface. Clearly this will begin to happen almost immediately on impervious surfaces. Only after these tiny reservoirs have been filled will overland flow commence and contribute to the runoff from the catchment. Since these surface depressions are not uniformly distributed it is quite possible that runoff will commence from some fraction of the catchment area before the depression storage on another fraction is completely filled. Typical recommended values for surface depression storage are given in Table 3.3.

The effective rainfall is thus that portion of the storm rainfall that contributes directly to the surface runoff hydrograph. This might be expressed as follows:

$$\text{Runoff, } Q_t = \text{Precipitation, } P_t - \text{Interception Depth} \\ - \text{Infiltrated Volume} - \text{Surface Depression Storage}$$

All of the terms are expressed in units of depth.

A number of methods are available to estimate the effective rainfall and thus the amount of runoff for any particular storm event. These range from the runoff coefficient  $C$  of the rational method to relatively sophisticated computer implementations of semi-empirical laws representing the physical processes. The method selected should be based on the size of the drainage area, the data available, and the degree of sophistication warranted for the design. Three methods for estimating effective rainfall are outlined.

### The Runoff Coefficient $C$ (Rational Method)

If an impervious area,  $A$ , is subjected to continuous and long-lasting rainfall of intensity,  $i$ , then, after a time (time of concentration  $T_c$ ), the runoff will be given by the equation:

$$Q = k \cdot i \cdot A$$

The rational method assumes that all of the abstractions may be represented by a single coefficient of volumetric runoff  $C$  so that in general the equation reduces to:

$$Q = k \cdot C \cdot i \cdot A$$

where:  $Q$  = runoff in  $\text{m}^3/\text{s}$  ( $\text{ft}^3/\text{s}$ )  
 $i$  = intensity in  $\text{mm}/\text{hr}$  ( $\text{in.}/\text{hr}$ )  
 $A$  = drainage area in hectares (acres)  
 $k$  = constant = 0.00278 for SI units ( $k=1$  for Imperial units)

When using the rational method, the following assumptions are considered:



- a) The rainfall intensity is uniform over the entire watershed during the entire storm duration.
- b) The maximum runoff rate occurs when the rainfall lasts as long or longer than the time of concentration.
- c) The time of concentration is the time required for the runoff from the most remote part of the watershed to reach the point under design.

Since  $C$  is the only manipulative factor in the rational formula, the runoff is directly proportional to the value assigned to  $C$ . Care should be exercised in selecting the value as it incorporates all of the hydrologic abstractions, soil types and antecedent conditions. Table 3.4 lists typical values for  $C$  as a function of land use for storms of approximately 5 to 10 year return period. It is important to note that the appropriate value of  $C$  depends on the magnitude of the storm and significantly higher values of  $C$  may be necessary for more extreme storm events. This is perhaps one of the most serious of the deficiencies associated with this method.

**Table 3.3 Typical Recommended Values for Surface Depression Storage<sup>6,7</sup>**

Land Cover	Recommended Value	
	(mm)	(in.)
Large Paved Areas	2.5	0.1
Roofs, Flat	2.5	0.1
Fallow Land Field Without Crops	5.0	0.2
Fields with Crops (grain, root crops)	7.5	0.3
Grass Areas in Parks, Lawns	7.5	0.3
Wooded Areas and Open Fields	10.0	0.4

### The Soil Conservation Service Method

The Soil Conservation Service (SCS) method<sup>3</sup> developed a relationship between rainfall ( $P$ ), retention ( $S$ ), and effective rainfall or runoff ( $Q$ ). The retention or potential storage in the soil is established by selecting a curve number (CN). The curve number is a function of soils type, ground cover and Antecedent Moisture Condition (AMC).

The hydrological soil groups, as defined by SCS soil scientists, are:

- a) (Low runoff potential) Soils having a high infiltration rate even when thoroughly wetted and consisting chiefly of deep, well to excessively drained sands or gravel.
- b) Soils having a moderate infiltration rate when thoroughly wetted and consisting chiefly of moderately deep to deep, moderately well to well drained soils with moderately fine to moderately coarse texture.
- c) Soils having a slow infiltration rate when thoroughly wetted and consisting chiefly of soils with a layer that impedes downward movement of water or soils with moderately fine to fine texture.
- d) (High runoff potential) Soils having a very slow infiltration rate when thoroughly wetted and consisting chiefly of clay soils with a high swelling potential, soils with a permanent high water table, soils with a claypan or clay layer at or near the surface and shallow soils over nearly impervious material.

**Table 3.4 Recommended Runoff Coefficients<sup>8</sup>**

Description of Area	Runoff Coefficients
<b>Business</b>	
Downtown . . . . .	0.70 to 0.95
Neighborhood . . . . .	0.50 to 0.70
<b>Residential</b>	
Single-family . . . . .	0.30 to 0.50
Multi-units, detached . . . . .	0.40 to 0.60
Multi-units, attached . . . . .	0.60 to 0.75
Residential (suburban) . . . . .	0.25 to 0.40
Apartment . . . . .	0.50 to 0.70
<b>Industrial</b>	
Light . . . . .	0.50 to 0.80
Heavy . . . . .	0.60 to 0.90
Parks, cemeteries . . . . .	0.10 to 0.25
Playgrounds . . . . .	0.20 to 0.35
Railroad yard . . . . .	0.20 to 0.35
Unimproved . . . . .	0.10 to 0.30

It often is desirable to develop a composite runoff based on the percentage of different types of surface in the drainage area. This procedure often is applied to typical "sample" blocks as a guide to selection of reasonable values of the coefficient for an entire area. Coefficients with respect to surface type currently in use are:

Character of Surface	Runoff Coefficients
<b>Pavement</b>	
Asphalt and Concrete . . . . .	0.70 to 0.95
Brick . . . . .	0.70 to 0.85
Roofs . . . . .	0.75 to 0.95
<b>Lawns, sandy soil</b>	
Flat, 2 percent . . . . .	0.13 to 0.17
Average, 2 to 7 percent . . . . .	0.18 to 0.22
Steep, 7 percent . . . . .	0.25 to 0.35

The coefficients in these two tabulations are applicable for storms of 5- to 10-yr frequencies. Less frequent, higher intensity storms will require the use of higher coefficients because infiltration and other losses have a proportionally smaller effect on runoff. The coefficients are based on the assumption that the design storm does not occur when the ground surface is frozen.

Knowing the hydrological soil group and the corresponding land use, the runoff potential or CN value of a site may be determined. Table 3.5 lists typical CN values.

Three levels of Antecedent Moisture Conditions are considered in the SCS method. It is defined as the amount of rainfall in a period of five to 30 days preceding the design storm. In general, the heavier the antecedent rainfall, the greater the runoff potential.

**AMC I** — Soils are dry but not to the wilting point. This is the lowest runoff potential.

**AMC II** — The average case.

**AMC III** — Heavy or light rainfall and low temperatures having occurred during the previous five days. This is the highest runoff potential.

The CN values in Table 3.5 are based on antecedent condition II. Thus, if moisture conditions I or III are chosen, then a corresponding CN value is determined (see Table 3.6).

The potential storage in the soils is based on an initial abstraction ( $I_a$ ), which is the interception, infiltration and depression storage prior to runoff and infiltration after runoff.

The effective rainfall is defined by the relationship.

$$Q = \frac{(P - I_a)^2}{P + S - I_a} \quad \text{where } S = \left( \frac{100}{\text{CN}} \right) - 10 \cdot 25.4$$

The original SCS method assumed the value of  $I_a$  to be equal to  $0.2 S$ . However, many engineers have found that this may be overly conservative, especially for moderated rainfall events and low CN values. Under these conditions the  $I_a$  value may be reduced to be a lesser percentage of  $S$  or may be estimated and input directly to the above equation.

### The Horton Infiltration Equation

The Horton equation<sup>9</sup>, which defines the infiltration capacity of the soil, changes the initial rate,  $f_o$ , to a lower rate,  $f_c$ . The infiltration capacity is an upper bound and is realized only when the available rainfall equals or exceeds the infiltration capacity. Therefore, if the infiltration capacity is given by:

$$f_{\text{cap}} = f_c + (f_o - f_c) e^{-t \cdot k}$$

Then the actual infiltration,  $f$ , will be defined by one or the other of the following two equations:

$$\begin{aligned} f &= f_{\text{cap}} \quad \text{for } i \geq f_{\text{cap}} \\ f &= i \quad \text{for } i \leq f_{\text{cap}} \end{aligned}$$

In the above equations:

- $f$  = actual infiltration rate into the soil
- $f_{\text{cap}}$  = maximum infiltration capacity of the soil
- $f_o$  = initial infiltration capacity
- $f_c$  = final infiltration capacity
- $i$  = rainfall intensity
- $k$  = exponential decay constant (1/hours)
- $t$  = elapsed time from start of rainfall (hours)

Figure 3.7 shows a typical rainfall distribution and infiltration curve.

For the initial timesteps, the infiltration rate exceeds the rainfall rate. The reduction in infiltration capacity is dependent more on the reduction in storage capacity in the soil rather than the elapsed time from the start of rainfall. To account for this the infiltration curve should, therefore, be shifted (dashed line for first timestep,  $\Delta t$ ) by an elapsed time that would equate the infiltration volume to the volume of runoff.

A further modification is necessary if surface depression is to be accounted for. Since the storage depth must be satisfied before overland flow can occur, the initial finite values of the effective rainfall hyetograph must be reduced to zero until a depth equivalent to the surface depression storage has been accumulated. The final hyetograph is the true effective rainfall that will generate runoff from the catchment surface.

**Table 3.5 Runoff Curve Numbers<sup>2</sup>**

Runoff curve number for selected agricultural suburban and urban land use  
(Antecedent moisture condition II and  $I_a = 0.2 S$ )

Land Use Description		Hydrologic Soil Group			
Cultivated Land <sup>1</sup> :	without conservation treatment	72	81	88	91
	with conservation treatment	62	71	78	81
Pasture or Range Land:	poor condition	68	79	86	89
	good condition	39	61	74	80
Meadow:	good condition	30	58	71	78
Wood or Forest Land:	thin stand, poor cover, no mulch	45	66	77	83
	good cover <sup>2</sup>	25	55	70	77
Open Spaces, Lawns, Parks, Golf Courses, Cemeteries, etc.	Good Condition: grass cover on 75% or more of the area	39	61	74	80
	Fair Condition: grass cover on 50% to 75% of the area	49	69	79	84
Commercial and Business Areas (85% impervious)		89	92	94	95
Industrial Districts (72% impervious)		81	88	91	93
Residential <sup>3</sup> :					
	Average lot size      Average % Impervious <sup>4</sup>				
	1/20 hectare or less ( $1/8$ acre)      65	77	85	90	92
	1/10 hectare ( $1/4$ acre)      38	61	75	83	87
	3/20 hectare ( $1/3$ acre)      30	57	72	81	86
	1/5 hectare ( $1/2$ acre)      25	54	70	80	85
	2/5 hectare (1 acre)      20	51	68	79	84
Paved Parking Lots, Roofs, Driveways, etc. <sup>5</sup>		98	98	98	98
Streets and Roads:					
	paved with curbs and storm sewers <sup>5</sup>	98	98	98	98
	gravel	76	85	89	91
	dirt	72	82	87	89

- Notes:**
- 1 For a more detailed description of agricultural land use curve numbers, refer to National Engineering Handbook, Section 4, Hydrology, Chapter 9, Aug. 1972<sup>3</sup>.
  - 2 Good cover is protected from grazing and litter and brush cover soil.
  - 3 Curve numbers are computed assuming the runoff from the house and driveway is directed toward the street with a minimum of roof water directed to lawns where additional infiltration could occur.
  - 4 The remaining pervious areas (lawn) are considered to be in good pasture condition for these curve numbers.
  - 5 In some warmer climates of the country, a curve number of 95 may be used.

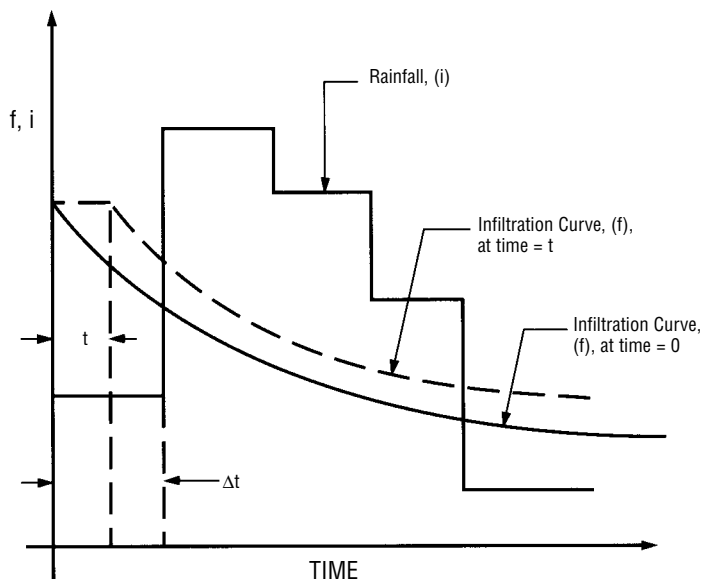
**Table 3.6 Curve Number Relationships for Different Antecedent Moisture Conditions**

CN for Condition II	CN for Conditions I & III		CN for Condition II	CN for Conditions I & III	
100	100	100	60	40	78
99	97	100	59	39	77
98	94	99	58	38	76
97	91	99	57	37	75
96	89	99	56	36	75
95	87	98	55	35	74
94	85	98	54	34	73
93	83	98	53	33	72
92	81	97	52	32	71
91	80	97	51	31	70
90	78	96	50	31	70
89	76	96	49	30	69
88	75	95	48	29	68
87	73	95	47	28	67
86	72	94	46	27	66
85	70	94	45	26	65
84	68	93	44	25	64
83	67	93	43	25	63
82	66	92	42	24	62
81	64	92	41	23	61
80	63	91	40	22	60
79	62	91	39	21	59
78	60	90	38	21	58
77	59	89	37	20	57
76	58	89	36	19	56
75	57	88	35	18	55
74	55	88	34	18	54
73	54	87	33	17	53
72	53	86	32	16	52
71	52	86	31	16	51
70	51	85	30	15	50
69	50	84			
68	48	84	25	12	43
67	47	83	20	9	37
66	46	82	15	6	30
65	45	82	10	4	22
64	44	81	5	2	13
63	43	80	0	0	0
62	42	79			
61	41	78			

The selection of the parameters for the Horton equation depends on soil type, vegetal cover and antecedent moisture conditions. Table 3.7 shows typical values for  $f_0$  and  $f_c$  (mm/hour or in./hr) for a variety of soil types under different crop conditions. The value of the lag constant should be typically between 0.04 and 0.08.

### Comparison of the SCS and Horton Methods

Figure 3.8 illustrates the various components of the rainfall runoff process for the SCS and Horton methods. The following example serves to show some of the difference between use of the SCS method in which the initial abstraction is used and the moving curve Horton method in which surface depression storage is significant. The incident storm is assumed to be represented by a second quartile Huff curve with a total depth of 50 mm (1.9 in.) and a duration of 120 minutes. In one case, the SCS method is used with the initial abstraction set at an absolute value of  $I_a = 6.1$  mm (0.24 in.). The curve number used is 87.6. Figure 3.9(a) shows that no runoff occurs until approximately 30 minutes have elapsed at which time the rainfall has satisfied the initial abstraction. From that point, however, the runoff, although small, is finite and continues to be so to the end of the storm.



**Figure 3.7** Representation of the Horton equation.

The Horton case is tested using values of  $f_o = 30$  mm/hr (1.18 in./hr);  $f_c = 10$  mm/hr (0.36 in./hr);  $K = 0.25$  hour and a surface depression storage depth of 5 mm (0.2 in.). These values have been found to give the same volumetric runoff coefficient as the SCS parameters. Figure 3.9(b) shows that infiltration commences immediately and absorbs all of the rainfall until approximately 30 minutes have elapsed. However, the initial excess surface water has to fill the surface depression storage, which delays the commencement of runoff for a further 13 minutes. Moreover, after 72 minutes, the rainfall intensity is less than  $f_c$  and runoff is effectively stopped at that time.

It will be found that the effective rainfall hyetograph generated using the Horton method has more leading and trailing “zero” elements so that the effective hyetograph is shorter but more intense than that produced using the SCS method.

### Establishing the Time of Concentration

Apart from the area and the percentage of impervious surface, one of the most important characteristics of a catchment is the time that must elapse until the entire area is contributing to runoff at the outflow point. This is generally called the Time of Concentration,  $T_c$ . This time is composed of two components:

- a) The time for overland flow to occur from a point on the perimeter of the catchment to a natural or artificial drainage conduit or channel.
- b) The travel time in the conduit or channel to the outflow point of the catchment.

In storm sewer design, the time of concentration may be defined as the inlet time plus travel time. Inlet times used in sewer design generally vary from 5 to 20 minutes, with the channel flow time being determined from pipe flow equations.

**Table 3.7** Typical values for the Horton equation parameters<sup>9</sup>

Land Surface Types	Loam, Clay K = 0.08		Clavey Sand K = 0.06		Sand, Loess, Gravel K = 0.04	
	$f_o$	$f_c$	$f_o$	$f_c$	$f_o$	$f_c$
Fallow land field without crops	15	8	33	10	43	15
Fields with crops (grain, root crops, vines)	36	3	43	8	64	10
Grassed verges, playground, ski slopes	20	3	20	3	20	3
Uncompacted grassy surface, grass areas in parks, lawns	43	8	64	10	89	18
Gardens, meadows, pastures	64	10	71	15	89	18
Coniferous woods	53*	53*	71*	71*	89*	89*
City parks, woodland, orchards	89	53	89	71	89*	89*

Notes: \*K = 0

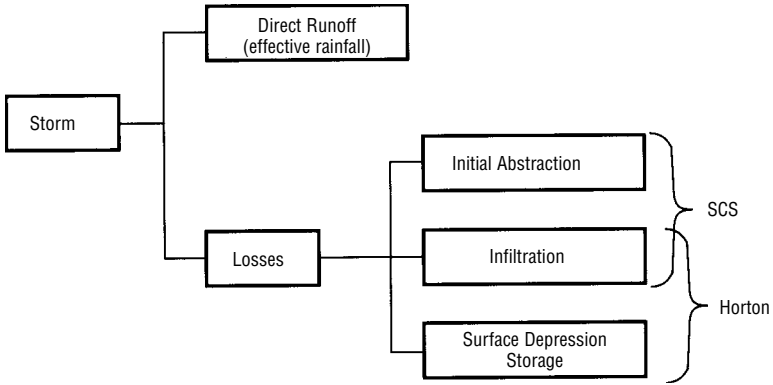


Figure 3.8 Conceptual components of rainfall.

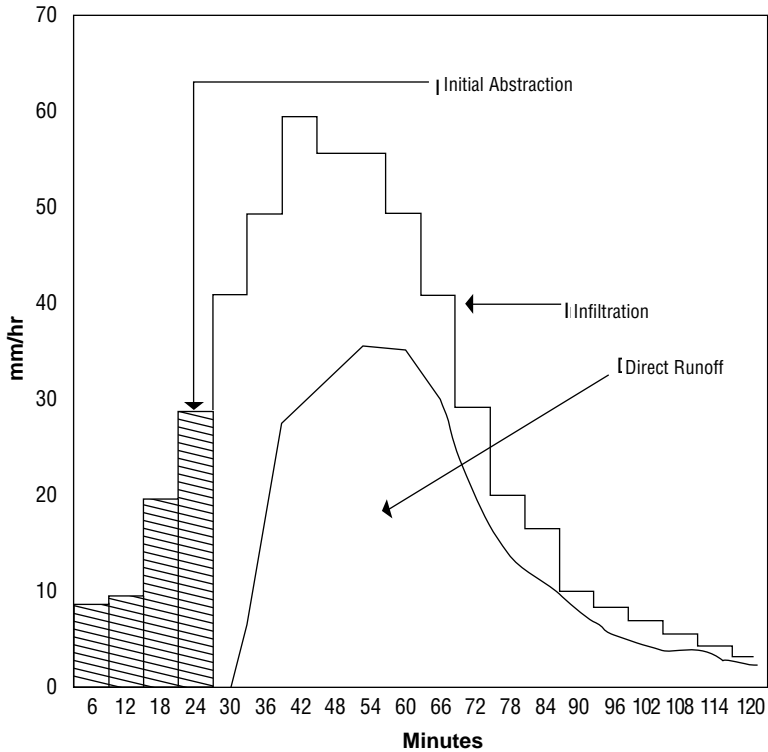
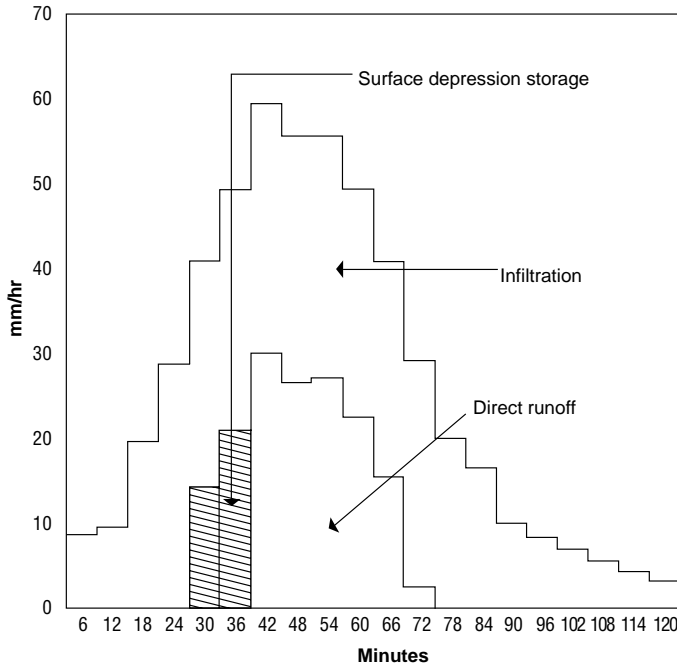


Figure 3.9a SCS Method with  $I_a = 6.1$  mm (0.24 in.) and  $CN = 87.6$ .





**Figure 3.9b** Horton equation  $f_0 = 30$  mm (1.18 in.),  $f_c = 10$  mm (0.36 in.),  $K = 0.25$   
Surface depression storage = 4 mm (0.2 in.)

### Factors Affecting Time of Concentration

The time taken for overland flow to reach a conduit or channel depends on a number of factors:

- a) Overland flow length ( $L$ ). This should be measured along the line of greatest slope from the extremity of the catchment to a drainage conduit or channel. Long lengths result in long travel times.
- b) Average surface slope ( $S$ ). Since  $T_c$  is inversely proportional to  $S$ , care must be exercised in estimating an average value for the surface slope.
- c) Surface roughness. In general, rough surfaces result in long travel times and vice versa. Thus, if a Manning equation is used to estimate the velocity of overland flow,  $T_c$  will be proportional to the Manning roughness factor,  $n$ .
- d) Depth of overland flow ( $y$ ). It seems reasonable to assume that very shallow surface flows move more slowly than deeper flows. However, the depth of flow is not a characteristic of the catchment alone but depends on the intensity of the effective rainfall or surface moisture excess.

Several methods of estimating the Time of Concentration are described below. Since it is clear that this parameter has a strong influence on the shape of the runoff hydrograph, it is desirable to compare the value to that obtained from observation, if possible. In situations where insufficient historical data are available, it may help to compare the results obtained by two or more methods. The impact on the resultant hydrograph due to using different methods for establishing the time of concentration should then be assessed.

### The Kirpich Formula

This empirical formula<sup>10</sup> relates  $T_c$  to the length and average slope of the basin by the equation:

$$T_c = 0.00032 L^{0.77} S^{-0.385} \quad (\text{See Figure 3.10})$$

Where,  $T_c$  = time of concentration in hours  
 $L$  = maximum length of water travel in meters (ft)  
 $S$  = surface slope, given by  $H/L$   
 $H$  = difference in elevation between the most remote point on the basin and the outlet, in meters (ft)

From the definition of  $L$  and  $S$ , it is clear that the Kirpich equation combines both the overland flow or entry time and the travel time on the channel or conduit. It is, therefore, particularly important that in estimating the drop  $H$ , the slope  $S$  and ultimately the time of concentration  $T_c$ , an allowance, if applicable, be made for the inlet travel time.

The Kirpich equation is normally used for natural basins with well defined routes for overland flow along bare earth or mowed grass roadside channels. For overland flow on grassed surfaces, the value of  $T_c$  obtained should be doubled. For overland flow on concrete or asphalt surfaces, the value should be reduced by multiplying by 0.4. For concrete channels, a multiplying factor of 0.2 should be used.

For large watersheds, where the storage capacity of the basin is significant, the Kirpich formula tends to significantly underestimate  $T_c$ .

### The Uplands Method

When calculating travel times for overland flow in watersheds with a variety of land covers, the Uplands Method<sup>2</sup> may be used. This method relates the time of concentration to the basin slope, length and type of ground cover. The individual times are calculated with their summation giving the total travel time. A graphical solution can be obtained from Figure 3.11. However, it should be noted that the graph is simply a log-log plot of values of  $V/S^{0.5}$  given in the following table.



Twin outfall lines for major urban storm sewer system.

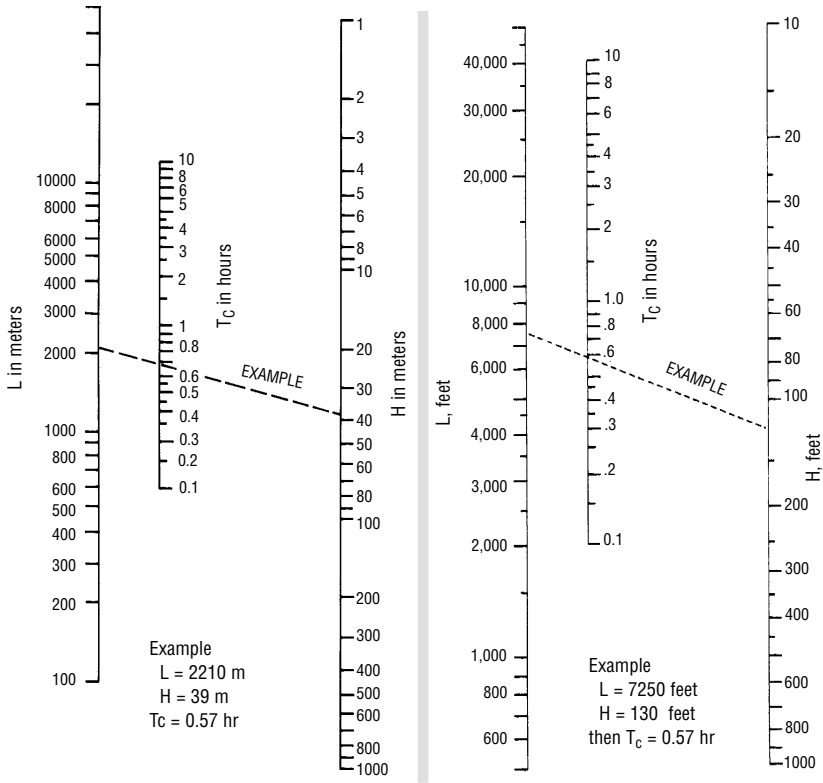


Figure 3.10  $T_c$  nomograph using the Kirpich formula.

### The Kinematic Wave Method

The two methods described above have the advantage of being straight forward and may be used for either simple or more complex methods of determining the runoff. Apart from the empirical nature of the equations, the methods assume that the time of concentration is independent of the depth of overland flow or, more generally, the magnitude of the input. A method in common use that is more physically based and that also reflects the dependence of  $T_c$  on the intensity of the effective rainfall is the Kinematic Wave method.

The method was proposed by Henderson<sup>11</sup> to analyze the kinematic wave resulting from rainfall of uniform intensity on an impermeable plane surface or rectangular area. The resulting equation is as follows:

$$T_c = k (L n / S)^{0.6} i_{\text{eff}}^{-0.4}$$

- in which
- $k = 6.98$  for SI units (0.939 for Imperial Units)
  - $L =$  Length of overland flow m (ft)
  - $n =$  Manning's roughness coefficient
  - $S =$  Average slope of overland flow m/m (ft/ft)
  - $i_{\text{eff}} =$  Effective rainfall intensity mm/hr (in./hr)

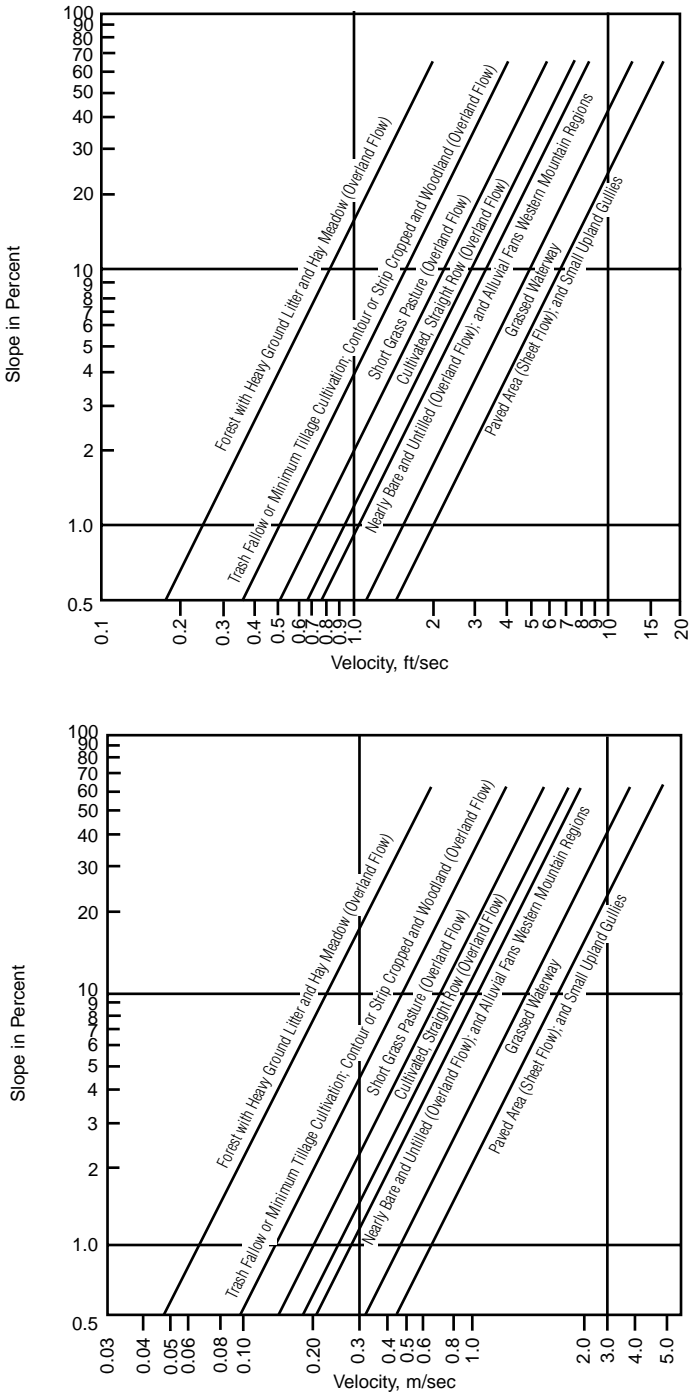


Figure 3.11 Velocities for Upland method for estimating travel time for overland flow.

**$V/S^{0.5}$  Relationship for Various Land Covers**

Land Cover	$V/S^{0.5}$ (m/s)	$V/S^{0.5}$ (ft/s)
Forest with Heavy Ground Litter, Hay Meadow (overland flow)	0.6	2.0
Trash Fallow or Minimum Tillage Cultivation; Contour, Strip Cropped, Woodland (overland flow)	1.5	5.0
Short Grass Pasture (overland flow)	2.3	7.5
Cultivated, Straight Row (overland flow)	2.7	9.0
Nearly Bare and Untilled (overland flow) or Alluvial Fans in Western Mountain Regions	3.0	10.0
Grassed Waterway	4.6	15.0
Paved Areas (sheet flow); Small Upland Gullies	6.1	20.0

**Other Methods**

Other methods have been developed that determine  $T_c$  for specific geographic regions or basin types. These methods are often incorporated into an overall procedure for determining the runoff hydrograph. Before using any method, the user should ensure that the basis on which the time of concentration is determined is appropriate for the area under consideration.

**DETERMINATION OF THE RUNOFF HYDROGRAPH**

The following sections outline alternative methods for generating the runoff hydrograph. Emphasis will be given to establishing the hydrograph for single storm events. Methods for estimating flow for urban and rural conditions are given.

Irrespective of the method used, it should be ensured that wherever possible the results should be compared with historical values. In many cases a calibration/validation exercise will aid in the selection of the most appropriate method.

All of the methods described could be carried out using hand calculations; however, for all but the simplest cases the exercise would be very laborious. Furthermore, access to many tested computer models has been made easier in recent years due to the widespread use of microcomputers. For these reasons emphasis will be placed on describing the basis of each method and the relevant parameters. A subsequent section will relate the methods to several computer models.

Rainfall runoff models may be grouped into two general classifications that analyze losses (i.e., to initial infiltration and depression storage) and effective rainfall. The effective rainfall hyetograph is then used as input to a catchment model to pro-



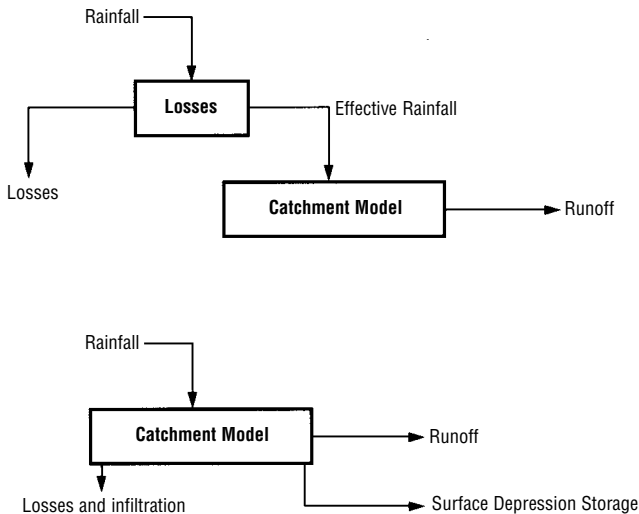
Ease of installation of CSP through existing concrete box.

duce a runoff hydrograph. It follows from this approach that infiltration must stop at the end of the storm.

The alternative approach employs a surface water budget in which the infiltration or loss mechanism is incorporated into the catchment model. In this method, the storm rainfall is used as input and the estimation of infiltration and other losses is made an integral part of the calculation of runoff. This approach implies that infiltration will continue as long as the average depth of excess water on the surface is finite. Clearly, this may continue after the cessation of rainfall.

### SCS Unit Hydrograph Method

A unit hydrograph represents the runoff distribution over time for one unit of rainfall excess over a drainage area. This method assumes that the ordinates of flow are proportional to the volume of runoff from any storm of the same duration. Therefore, it is possible to derive unit hydrographs for various rainfall blocks by convoluting the unit hydrograph with the effective rainfall distribution. The unit hydrograph theory is based on the following assumptions.



**Figure 3.12** Classification of rainfall-runoff models: Effective Rainfall (top) & Surface Water Budget (bottom)

- a) For a given watershed, runoff-producing storms of equal duration will produce surface runoff hydrographs with approximately equivalent time bases, regardless of the intensity of the rain.
- b) For a given watershed, the magnitude of the ordinates representing the instantaneous discharge from an area will be proportional to the volumes of surface runoff produced by storms of equal duration.
- c) For a given watershed, the time distribution of runoff from a given storm period is independent of precipitation from antecedent or subsequent storm periods.

The U.S. Soil Conservation Service, based on the analysis of a large number of hydrographs, proposed a unit hydrograph that requires only an estimate of the time to peak  $t_p$ . Two versions of this unit hydrograph were suggested, one being curvilinear in shape, the other being a simple asymmetric triangle as shown in Figure 3.13. In the standard procedure, the duration of the recession link is assumed to be  $t_r = (2/3)t_p$  so that the time base is given by  $t_b = (8/3)t_p$ .

The ordinates of the unit hydrograph are expressed in units of discharge per unit depth of effective rainfall. It follows, therefore, that the area under the triangle must equal the total contributing area of the catchment, so that, in terms of the notation used in Figure 3.13:

$$q_p = 2A/t_b \\ = 0.75 A/t_p \text{ for } t_b = (8/3) t_p$$

Expressed in SI units the above equation becomes:

$$q_p = 0.75 (A \times 1000^2 \times \frac{1}{1000}) / (t_p \times 3600)$$

or  $q_p = 0.208 A / t_p$  or  $= 484 A / t_p$  (US Imperial Units)

where  $A$  is in  $\text{km}^2$  ( $\text{mi}^2$ )

$t_p$  is in hours, and

$q_p$  peak flow is in  $\text{m}^3/\text{s}$  per mm ( $\text{ft}^3/\text{s}$  per inch) of effective rainfall

The numerical constant in the above equation is a measure of the storage in the watershed. This value, generally denoted as  $B$ , is usually taken to be about 0.13 for flat marshy catchments and 0.26 for steep flashy catchments.

The estimate of the time to peak  $t_p$  is based on the time of concentration  $T_c$  and the time step  $\Delta t$  used in the calculation using the relation:

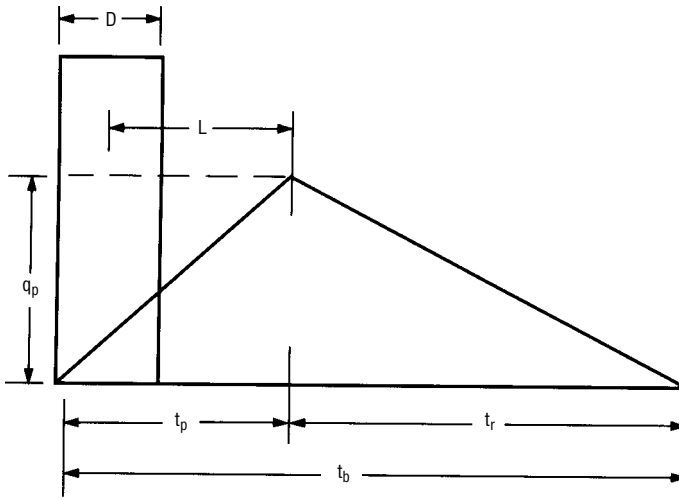
$$t_p = 0.5 \Delta t = 0.6 T_c$$

where  $T_c$  may be determined by any acceptable method such as those described in the previous section.

From the above equation it can be seen that the time to peak  $t_p$ , and therefore the peak of the Unit Hydrograph  $q_p$ , is affected by the value of timestep  $\Delta t$ . Values of  $\Delta t$  in excess of  $0.25 t_p$  should not be used as this can lead to underestimation of the peak runoff.

### Rectangular Unit Hydrograph

An alternative option to the triangular distribution used in the SCS method is the rectangular unit hydrograph. Figure 3.14 illustrates the concept of convoluting the



**Figure 3.13** SCS triangular unit hydrograph

Where:  $D$  = excess rainfall period (not to be confused with unit time or unit hydrograph duration)

$L$  = lag of watershed; time of center of mass of excess rainfall ( $D$ ) to the time to peak ( $t_p$ )

effective rainfall with a rectangular unit hydrograph. The ordinate of the unit hydrograph is defined as the area of the unit hydrograph divided by the time of concentration ( $T_c$ ).

The rational method is often used as a rough estimate of the peak flow. This method, which assumes the peak flow occurs when the entire catchment surface is contributing to runoff, may be simulated using a rectangular unit hydrograph. In this case the effective rainfall hydrograph is reduced to a simple rectangular function and  $i_{\text{eff}} = k \cdot C \cdot i$ . The effective rainfall with duration  $t_d$  is convoluted with a rectangular unit hydrograph, which has a base equal to the time of concentration  $T_c$ . If  $t_d$  is made equal to  $T_c$ , the resultant runoff hydrograph will be symmetrical and triangular in shape with a peak flow given by  $Q = k \cdot C \cdot i \cdot A$  and time base of  $t_b = 2 T_c$ . If the rainfall duration  $t_d$  is not equal to  $T_c$ , then the resultant runoff hydrograph is trapezoidal in shape with peak flow given by the equation below and a time base of  $t_b = t_d + T_c$ .

$$Q = k \cdot C \cdot i \cdot A \left( t_d / T_c \right) \quad \text{for } t_d \leq T_c$$

and 
$$Q = k \cdot C \cdot i \cdot A \quad \text{for } t_d > T_c$$

This approach makes no allowance for the storage effect due to the depth of overland flow and results in an “instantaneous” runoff hydrograph. This may be appropriate for impervious surfaces in which surface depression storage is negligible. However, for pervious or more irregular surfaces, it may be necessary to route the instantaneous hydrograph through a hypothetical reservoir in order to more closely represent the runoff hydrograph.



### Linear Reservoir Method

A more complex response function was suggested by Pederson<sup>12</sup> in which the shape of the unit hydrograph is assumed to be the same as the response of a single linear reservoir to an inflow of rectangular shape and of duration  $\Delta t$ . A linear reservoir is one in which the storage  $S$  is linearly related to the outflow  $Q$  by the relation:

$$S = K \cdot Q$$

where  $K$  = the reservoir lag or storage coefficient (e.g., in hours)

In the Pederson method, the value of  $K$  is taken to be  $0.5 T_c$  where  $T_c$  is computed from the kinematic wave equation in which the rainfall intensity used is the maximum for the storm being modelled. The use of  $i_{\max}$  is justified since this intensity tends to dominate the subsequent runoff hydrograph. The resulting Unit

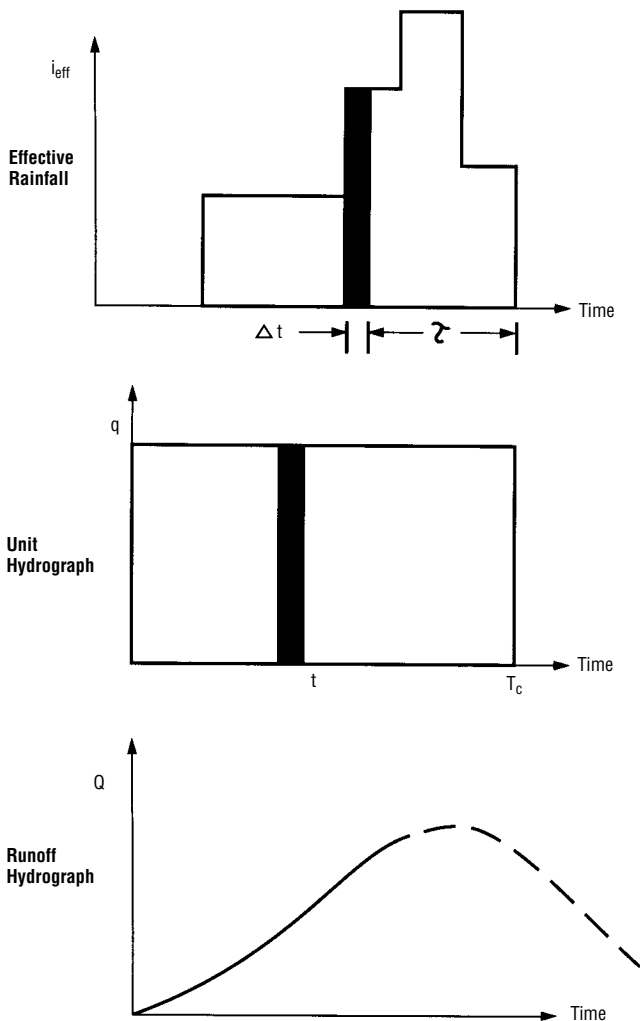


Figure 3.14 Convolution process using a rectangular unit hydrograph.

Hydrograph is illustrated in Figure 3.15 and comprises a steeply rising limb that reaches a maximum at time  $t = \Delta t$  followed by an exponential recession limb. The two curves can be described by the following equations.

$$q_p = [1 - e^{-\Delta t/k}] / \Delta t \quad \text{at } t = \Delta t$$

and

$$q = q_p \cdot e^{-(t - \Delta t)/k} \quad \text{for } t > \Delta t$$

An important feature of the method is that the unit hydrograph always has a time to peak at  $\Delta t$  and is incapable of reflecting different response times as a function of catchment length, slope or roughness. It follows that the peak of the runoff hydrograph will usually be close to the time of peak rainfall intensity irrespective of the catchment characteristics.

### SWMM Runoff Algorithm

The Storm Water Management Model was originally developed jointly for the U.S. Environmental Protection Agency in 1971<sup>13</sup>. Since then it has been expanded and improved by the EPA and many other agencies and companies. In particular, the capability for continuous simulation has been added to single event simulation, quality as well as quantity is simulated and snow-melt routines are included in some versions.

The model is intended for use in urban or partly urbanized catchments. It comprises five main “blocks” of code in addition to an Executive Block or supervisory calling program. This section describes the basic algorithm of the Runoff Block, which is used to generate the runoff hydrograph in the drainage system, based on a rainfall hyetograph, antecedent moisture conditions, land use and topography.

The method differs from those described above in that it does not use the concept of effective rainfall, but employs a surface water budget approach in which rainfall, infiltration, depression storage and runoff are all considered as processes

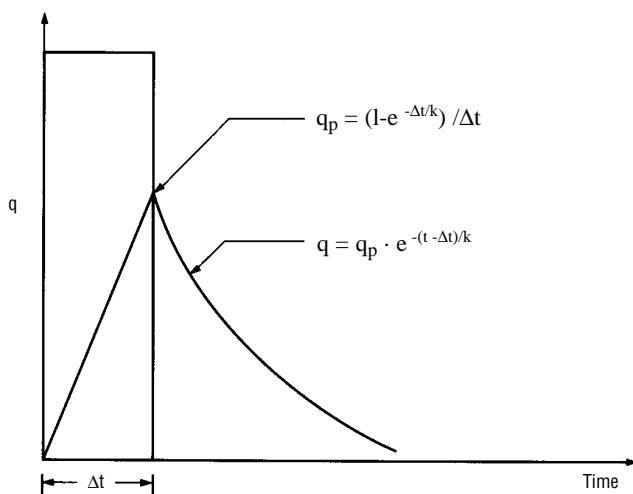
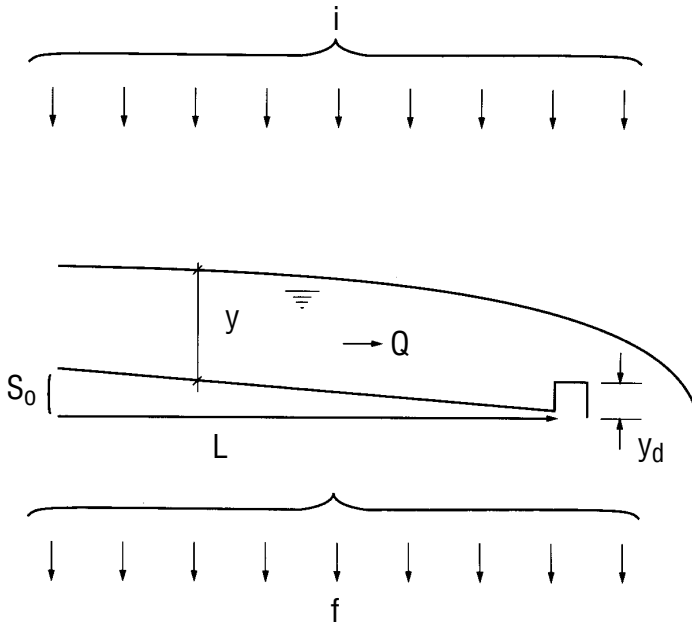


Figure 3.15 The single linear reservoir.



**Figure 3.16** Representation of the SWMM/Runoff algorithm.

occurring simultaneously at the land surface. The interaction of these inputs and outputs may be visualized with reference to Figure 3.16.

Treating each sub-catchment as an idealized, rectangular plane surface of breadth  $B$  and length  $L$ , the continuity or mass balance equation at the land surface is given by the statement:

$$\text{Inflow} = (\text{Infiltration} + \text{Outflow}) + \text{Rate of Surface Ponding}$$

That is:

$$i \cdot L \cdot B = (f \cdot L \cdot B + Q) + L \cdot B \cdot (\Delta y / \Delta t)$$

where  $i$  = Rainfall intensity  
 $f$  = Infiltration rate  
 $Q$  = Outflow  
 $y$  = Depth of flow over the entire surface

The depth of flow ( $y$ ) is computed using the Manning equation, taking into account the depth of depression surface storage ( $y_d$ ), which is also assumed to be uniform over the entire surface. This is the dynamic equation:

$$Q = B (1/n) (y - y_d)^{5/3} S^{1/2}$$

where  $n$  = Manning's roughness coefficient for overland flow  
 $S$  = Average slope of the overland flow surface

The infiltration rate ( $f$ ) must be computed using a method such as the "moving curve" Horton equation or the Green-Ampt model. Infiltration is assumed to occur as long as excess surface moisture is available from rainfall, depression storage or finite overland flow.

It is important to note that the value of Manning's "n" used for overland flow is somewhat artificial (e.g., in the range 0.1 to 0.4) and does not represent a value which can be used for channel flow calculation.

Various methods can be used for the simultaneous solution of the continuity and dynamic equation. One method is to combine the equations into one nondifferential equation in which the depth ( $y$ ) is the unknown. Once  $y$  is determined (e.g., by an interactive scheme such as the Newton-Raphson method) the outflow  $Q$  follows.

## COMPUTER MODELS

In recent years, many computer models have been developed for the simulation of the rainfall/runoff process. Table 3.8 lists several of these models and their capabilities.



Saddle branch manhole is bolted in place.

**Table 3.8 Hydrologic Computer Models**

Model Characteristics	Models													
	HEC-1 <sup>14</sup>	HYMO <sup>15</sup>	HSPF <sup>16</sup>	ILLUDAS <sup>17</sup>	MIDUSS <sup>18</sup>	OTTHYMO <sup>19</sup>	QUALHYMO <sup>20</sup>	SCS TR-20 <sup>21</sup>	SCS TR-55 <sup>21</sup>	SSARR <sup>22</sup>	STANFORD <sup>23</sup>	STORM <sup>24</sup>	SWMM <sup>13</sup>	USDAHL-74 <sup>25</sup>
Model Type:														
Single Event	•	•		•	•	•		•	•				•	
Continuous			•				•			•	•	•	•	•
Model Components:														
Infiltration	•	•	•	•	•	•	•	•	•	•	•	•	•	•
Evapotranspiration			•						•	•	•	•	•	•
Snowmelt	•		•						•	•	•	•	•	•
Surface Runoff	•	•	•	•	•	•	•	•	•	•	•	•	•	•
Subsurface Flow	•		•				•		•	•	•			•
Reservoir Routing	•	•	•		•	•	•	•	•	•		•	•	•
Channel Routing	•	•	•	•	•	•	•	•	•	•	•	•	•	•
Water Quality			•				•					•	•	
Application:														
Urban Land Use			•	•	•	•	•		•			•	•	
Rural Land Use	•	•	•		•	•	•	•	•	•	•	•	•	•
Ease of Use:														
High	•	•		•	•	•	•	•	•			•	•	•
Low			•						•	•		•	•	



## REFERENCES

1. Spangler, M.G., Handy, R.L, Soil Engineering, 4th Edition, Harper and Row Publishers, 1982.
2. Urban Hydrology for Small Watershed, U.S. Soil Conservation Service, Technical Release No. 55, 1975.
3. National Engineering Handbook, Section 4, Hydrology, U.S. Soil Conservation Service, 1972.
4. Keifer, L.S., Chu, H. H., "Synthetic Storm Pattern for Drainage Design," Proceedings ASCE, 1957.
5. Huff, F. A., "Time Distribution of Rainfall in Heavy Storms," Water Resources Research, 3140, pp. 1007-1019, 1967.
6. Tucker, L.S., "Availability of Rainfall Runoff Data for Partly Sewered Drainage Catchments," ASCE Urban Water Resources Program, Technical Memorandum No. 8.
7. "Hydrograph Volume Method of Sewer System Analysis," HVM Manual, Dorsch Consult Limited, Federal Republic of Germany, 1987.
8. "Design and Construction of Sanitary and Storm Sewers," Water and Pollution Control Federation Manual of Practice No. 9 and American Society of Civil Engineers Manuals and Reports on Engineering Practice No. 37, 1969.
9. Horton, R. E., "An Approach Toward a Physical Interpretation of Infiltration Capacity," Soil Science Society of America Proceedings, 5, pp. 399-417, 1940.
10. Kirpich, Z. P., "Time of Concentration in Small Agricultural Watersheds," Civil Engineering (New York), 10, p. 362, 1940.

11. Henderson, F.M., "Open Channel Flow", MacMillan Publishing Company, Inc., New York, NY, 1966.
12. Pederson, J. T., Peters, J. C., and Helweg, D. J., "Hydrology by Single Linear Reservoir Model" Proceedings ASCE, Journal of Hydraulics Division, 106 (HY5), pp. 837-842, 1980.
13. Huber, W.C., Heaney, J.P., Nix, S.J., Dickinson, R.E., and Polmann, D.J., "Storm water Management Model (SWMM), Version III," Users Manual, Municipal Environmental Research Laboratory, U.S. Environmental Protection Agency, Cincinnati, Ohio, 1982.
14. "HEC-1 Flood Hydrograph Package" Users Manual, Hydrologic Engineering Center, U.S. Army Corps of Engineers, Davis, California, 1973.
15. Williams, J.R., Hann, R.W., "HYMO: Problem Oriented Computer Language for Hydrologic Modeling," Users Manual, Agricultural Research Service, U.S. Department of Agriculture, Texas, 1978.
16. Johanson, R. D., Imhoff, J. C. and Davis, H.H., "Hydrological Simulation Program Fortran (HSPF)," Users Manual, U.S. Environmental Protection Agency, Environmental Research Laboratory, Athens, Georgia, 1980.
17. Terstriep, M. L., Stall, J. B., Illinois "Urban Drainage Area Simulator (ILLU-DAS), Illinois State Water Survey," Bulletin 58, Urbana, Illinois, 1974.
18. Smith, A.A., "Microcomputer Interaction Design of Urban Stormwater Systems (MIDUSS)," Users Manual, Version 4.2, Dundas, Ontario, 1987.
19. Wisner, P.E., and P'ng, C.E., OTTHYMO A Model for Master Drainage Plans, IMPSWMM Program, Department of Civil Engineering, University of Ottawa, Ottawa, Ontario, 1982.
20. Rowney, A. C., Wisner, P. E., "QUAL-HYMO Users Manual," Release 1.0, Department of Civil Engineering, University of Ottawa, Ottawa, Ontario, 1984.
21. "Computer Program for Project Formulation—Hydrology," Technical Release No. 20, U.S. Soil Conservation Service, U.S. Department of Agriculture, 1965.
22. "Streamflow Synthesis and Reservoir Regulation (SSARR)," Program Description and Users Manual, U.S. Army Engineer Division, Portland, Oregon, 1972.
23. Crawford, N. H., Linsley, R. K., "Digital Simulation in Hydrology: Stanford Watershed Model IV," Technical Report No. 39, Department of Civil Engineering, Stanford University, 1966.
24. "Storage, Treatment, Overflow Model (STORM)," Users Manual, Hydrologic Engineering Center, U.S. Army Corps of Engineers, Davis, California, 1977.
25. Holtan, H. N., Stiltner, G. J., Hanson, M. H., and Lopez, N. C., "USDAHL—74 Revised Model of Watershed Hydrology," Technical Bulletin No. 1518, Agricultural Research Service, U.S. Department of Agriculture, Washington, D.C., 1975.

## *BIBLIOGRAPHY*

Chow, V.T., Handbook of Applied Hydrology, McGraw-Hill Book Co., 1964.

Gray, D.M., Handbook on the Principles of Hydrology, National Research Council of Canada, 1970.

Handbook of Steel Drainage and Highway Construction Products, American Iron and Steel Institute, 1983.



Fabricated fittings reduce head losses in the system.



# Hydraulics of Storm Sewers

## CHAPTER 4

---

### INTRODUCTION

Storm sewers may be designed as either open channels, where there is a free water surface, or for pressure or “pipe” flow under surcharged conditions. When the storm sewer system is to be designed as pressure flow, it should be assured that the hydraulic grade line does not exceed the floor level of any adjacent basements or catch basin grate opening elevations where surcharge conditions may create unacceptable flooding or structural damages.

Regardless of whether the sewer system is to be designed as an open channel or pressure system, a thorough hydraulic analysis should be performed to assure that the system operates efficiently. Too often in the past a simplistic approach to the design of storm sewers was taken, with the design and sizing of conduits and appurtenances derived from nomographs or basic hydraulic flow equations.

As a result of this, excessive surcharging has been experienced in many instances due to improper design of the hydraulic structures. This in turn has led to flooding damage, both surface and structural, when service connections have been made to the storm sewer. Overloading of the sewer system may occur in upper reaches while lower segments may be flowing well below capacity because of the inability of the upper reaches to transport the flow or vice versa with downstream surcharging creating problems.

In conclusion, an efficient, cost effective storm drain system cannot be designed without a complete and proper hydraulic analysis.

The following section outlines the basic hydraulic principles for open channel and conduit flow. Subsequent sections of this chapter deal with losses (friction and form) within the sewer system and the hydraulics of storm water inlets. Manual calculations for designing a storm drainage system are presented in Chapter 5. An overview of several commonly used computer programs that may be used to design sewer systems is also given in Chapter 5.



CSP is easy to install in difficult trench conditions.

## CLASSIFICATION OF CHANNEL FLOW

Channel flow is distinguished from closed-conduit or pipe flow by the fact that the cross-section of flow is not dependent solely on the geometry of the conduit, but depends also on the free surface (or depth), which varies with respect to space and time and is a function of discharge. As a result, various categories of flow can be identified:

**STEADY** flow exhibits characteristics at a point that is constant with respect to time. Flow subject to very slow change may be assumed to be steady with little error.

**UNSTEADY** flow results when some time-dependent boundary condition—tide, floodwave or gate movement causes a change in flow and/or depth to be propagated through the system.

**UNIFORM** flow, strictly speaking, is flow in which velocity is the same in magnitude and direction at every point in the conduit. Less rigidly, uniform flow is assumed to occur when the velocity at corresponding points in the cross-section is the same along the length of the channel. Note that uniform flow is possible only if:

- flow is steady, or nearly so
- the channel is prismatic (i.e., has the same cross-sectional shape at all sections)
- depth is constant along the length of the channel
- the bedslope is equal to the energy gradient.

**NON-UNIFORM** or **VARIED** flow occurs when any of the requirements for uniform flow are not satisfied. Varied flow may be further sub-classified depending on the abruptness of the variation. Thus:

**GRADUALLY VARIED** flow occurs when depth changes occur over long distances such as the flow profiles or backwater profiles that occur between distinct reaches of uniform flow.

**RAPIDLY VARIED** flow occurs in the vicinity of transitions caused by relatively abrupt changes in channel geometry or where a hydraulic jump occurs.

Figure 4.1 illustrates various typical occurrences of these different classes of flow.

In the design of sewer systems, the flow, except where backwater or surcharging may occur, is generally assumed to be steady and uniform.

### Laws of Conservation

Fluid mechanics is based on the law of conservation applied to the mass, energy and momentum of a fluid in motion. Full details can be found in any text on the subject. At this point, it is sufficient to note that:

- a) Conservation of mass reduces to a simple statement of continuity for fluids in which the density is essentially constant.
- b) Conservation of energy is usually stated as the Bernoulli equation, which is discussed below.
- c) Conservation of momentum is significant in transitions where there are local and significant losses of energy, such as across a hydraulic jump.

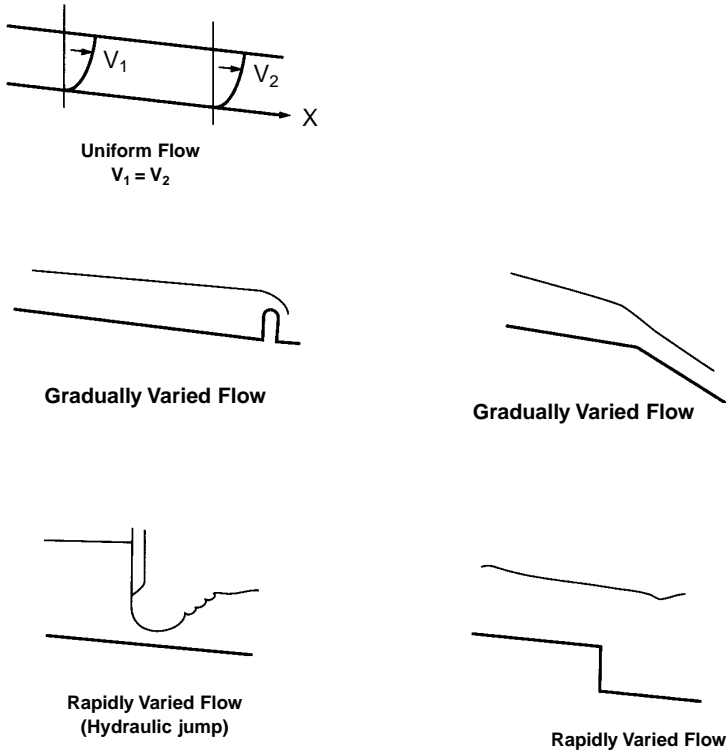


Figure 4.1 Different classes of open channel flow.

**Bernoulli Equation**

The law of conservation of energy as expressed by the Bernoulli Equation is the basic principle most often used in hydraulics. This equation may be applied to any conduit with a constant discharge. All the friction flow formulae such as the Manning’s, Cutter, Hazen-William’s, etc., have been developed to express the rate of energy dissipation as it applies to the Bernoulli Equation. The theorem states that the energy head at any cross-section must equal that in any other downstream section plus the intervening losses.<sup>1</sup>

In open channels, the flow is primarily controlled by the gravitational action on moving fluid, which overcomes the hydraulic energy losses. The Bernoulli Equation defines the hydraulic principles involved in open channel flow.

**Specific Energy**

An understanding of open channel flow is aided by the concept of Specific Energy E, which is simply the total energy when the channel bottom is taken to be the datum. Thus:

$$E = y + V^2/2g = y + Q^2/2gA^2$$

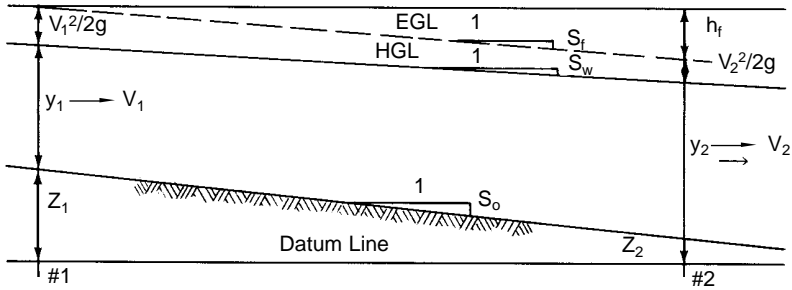


Figure 4.2 Energy in open channel flow.

$$H = y + \frac{V^2}{2g} + Z + h_f$$

- |                                  |                            |
|----------------------------------|----------------------------|
| H = Total Velocity Head          | $h_f$ = Headloss           |
| y = Water Depth                  | V = Mean Velocity          |
| $\frac{V^2}{2g}$ = Velocity Head | Z = Height above Datum     |
| EGL = Energy Grade Line          | HGL = Hydraulic Grade Line |
| $S_o$ = Slope of Bottom          | $S_f$ = Slope of EGL       |
|                                  | $S_w$ = Slope of HGL       |

The total energy at point #1 is equal to the total energy at point #2, thus

$$y_1 + Z_1 + \frac{V_1^2}{2g} = y_2 + Z_2 + \frac{V_2^2}{2g} + h_f$$

For pressure or closed conduit flow, the Bernoulli Equation can be written as:

$$\frac{V_1^2}{2g} + \frac{P_1}{\gamma} + Z_1 = \frac{V_2^2}{2g} + \frac{P_1}{\gamma} + Z_2 + h_f$$

where: P = pressure at given location

$\gamma$  = specific weight of fluid

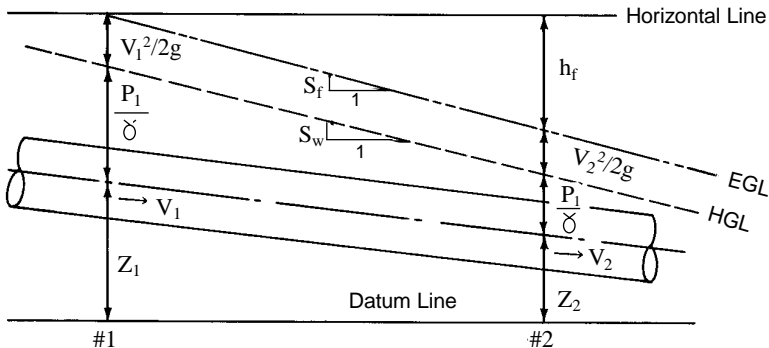


Figure 4.3 Energy in closed conduit flow.

Figure 4.4 shows a plot of specific energy as a function of depth of flow for a known cross-sectional shape and constant discharge  $Q$ . The turning value occurs where  $E$  is a minimum and defines the critical depth  $y_{cr}$ . The critical depth is defined by setting  $dE/dy = 0$  from which it can be shown that:

$$\frac{Q^2 T}{gA^3} = 1$$

in which the surface breadth,  $T$ , and cross-sectional area,  $A$ , are functions of the depth,  $y$ . The velocity corresponding to  $y_{cr}$  is called the critical velocity and is given by:

$$\frac{V_{cr}^2 T}{gA} = 1 \quad \text{or} \quad V_{cr} = (g A/T)^{1/2}$$

The critical velocity and hence the critical depth,  $y_{cr}$  is unique to a known cross-sectional shape and constant discharge,  $Q$ .

For the special case of rectangular cross-sections,  $A = B \cdot y$  and  $T = B$ , where  $B$  is the basewidth. In this case, the above equation for critical depth reduces to:

$$\frac{Q^2}{g \cdot B^3 \cdot y^2} = 1$$

from which the critical depth is found as  $y_{cr} = (Q^2/gB^2)^{1/3}$  and the corresponding critical velocity is  $V_{cr} = (g \cdot y)^{1/2}$ .

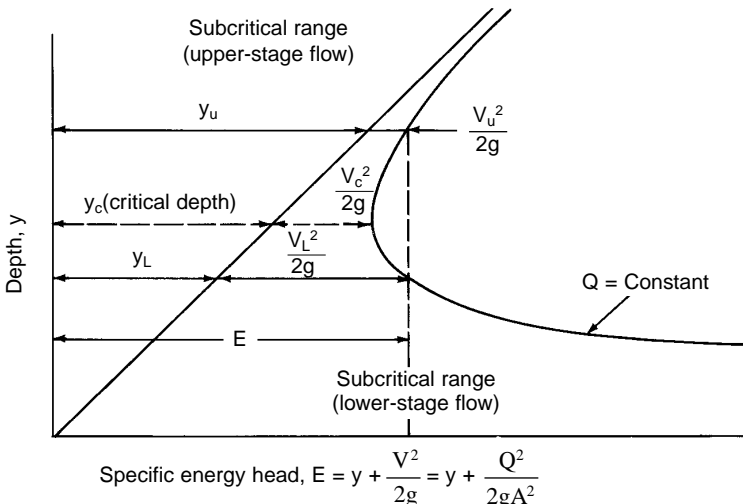


Figure 4.4 Typical plot of specific energy as a function of depth.

The critical depth serves to distinguish two more classes of open channel flow:

- $y > y_{cr}$  The specific energy is predominantly potential energy ( $y$ ), the kinetic energy is small and the velocity is less than  $V_{cr}$ . The flow is called **SUBCRITICAL** (i.e., with respect to velocity) or **TRANQUIL**.
- $y < y_{cr}$  Most of the specific energy is kinetic energy and the depth or potential energy is small. The velocity is greater than  $V_{cr}$  and the flow is therefore called **SUPERCritical** or **RAPID**.

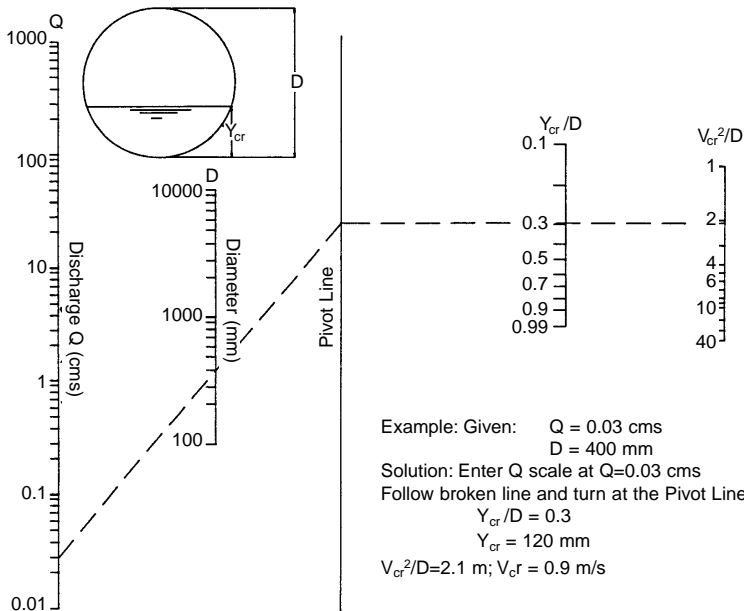
For circular conduits, Figures 4.5 provides a nomograph for calculating  $y_{cr}$ . For pipe arch CSP, pipe charts provide a graphical method of determining critical flow depths (Figures 4.6, 4.7).

**Energy Losses**

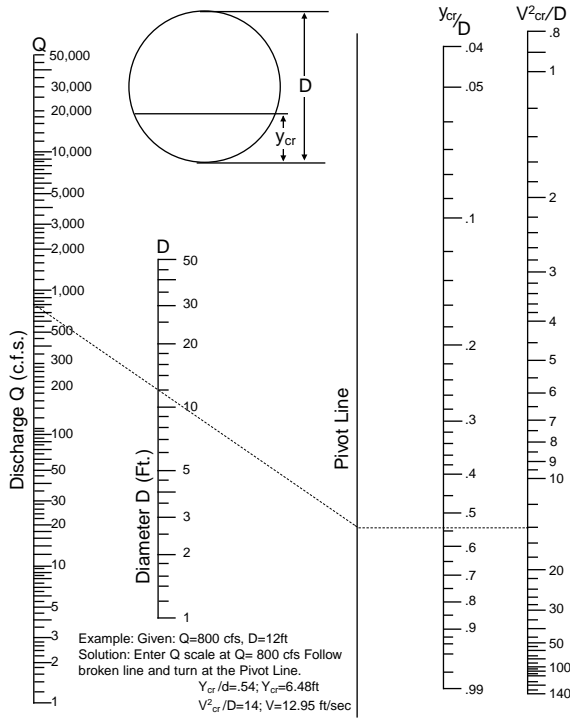
When using the Bernoulli Equation for hydraulic design, it is necessary to make allowance for energy losses as illustrated in Figure 4.2. The losses are expressed in terms of head and may be classified as:

- friction losses*—these are due to the shear stress between the moving fluid and the boundary material.
- form losses*—these are caused by abrupt transitions resulting from the geometry of manholes, bends, expansions and contractions.

It is a common mistake to include only friction losses in the hydraulic analysis. Form losses can constitute a major portion of the total head loss and, although estimates of form losses are generally based on empirical equations, it is important to make allowance for them in the design.



**Figure 4.5M** Critical flow and critical velocity in circular conduits



**Figure 4.5** Critical flow and critical velocity in circular conduits

**Friction Losses**

In North America, the Manning and Kutter equations are commonly used to estimate the friction gradient for turbulent flow in storm sewers. In both equations, fully developed rough turbulent flow is assumed so that the head loss per unit length of conduit is approximately proportional to the square of the discharge



Proper installation techniques are always important.

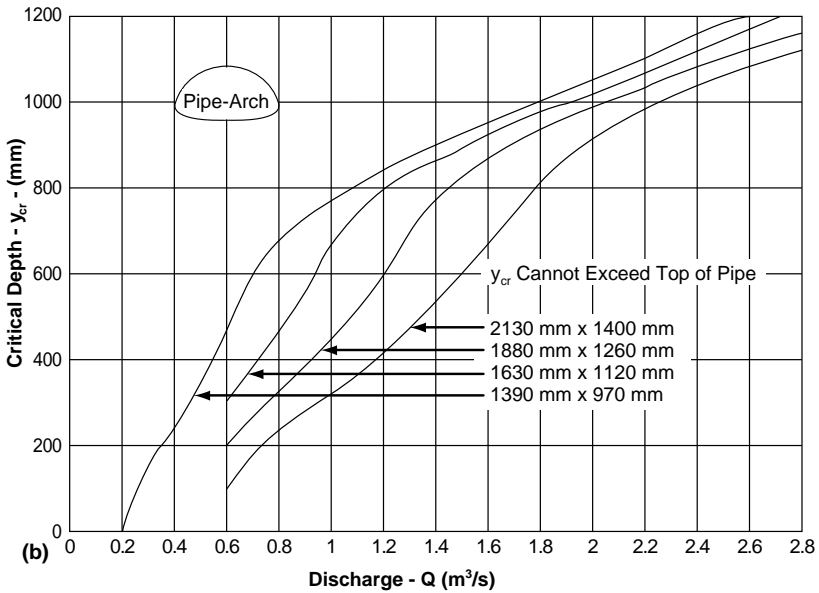
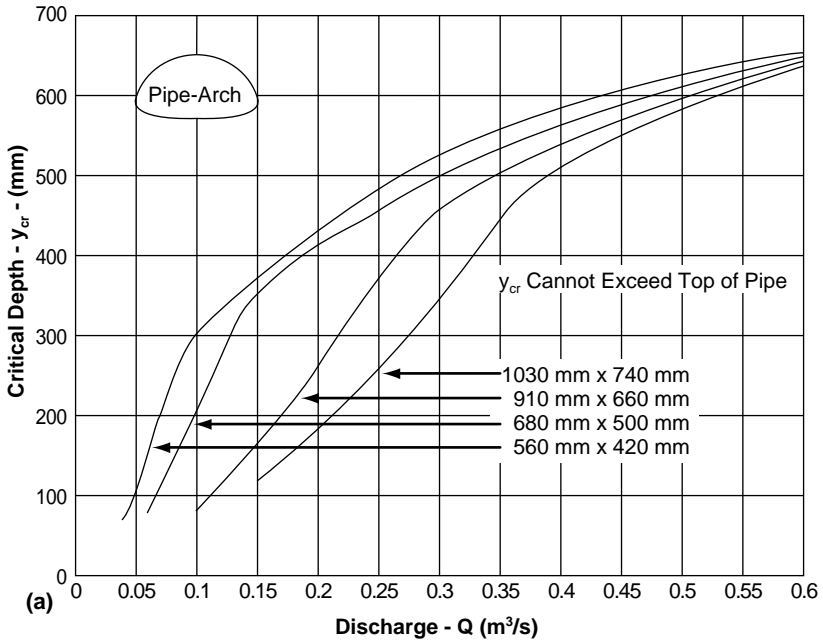


Figure 4.6M Critical depth curves for standard corrugated steel pipe (adapted from Federal Highway Administration)<sup>2</sup>.



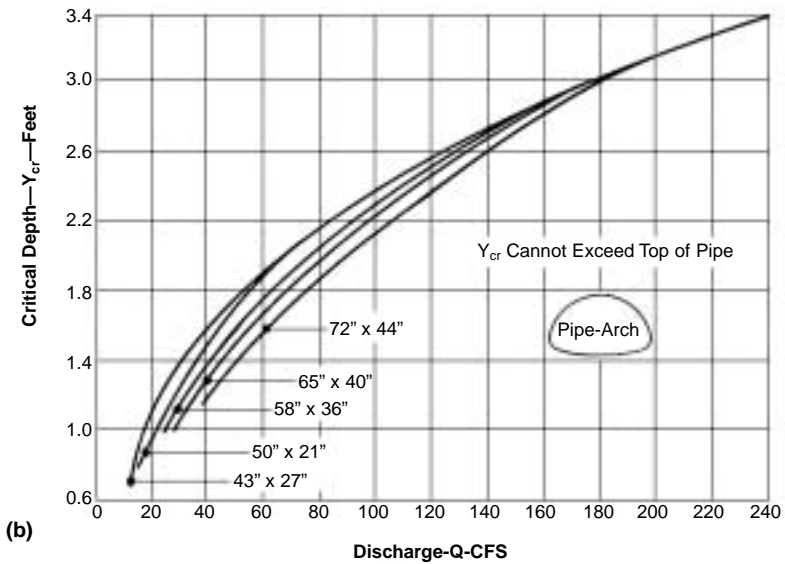
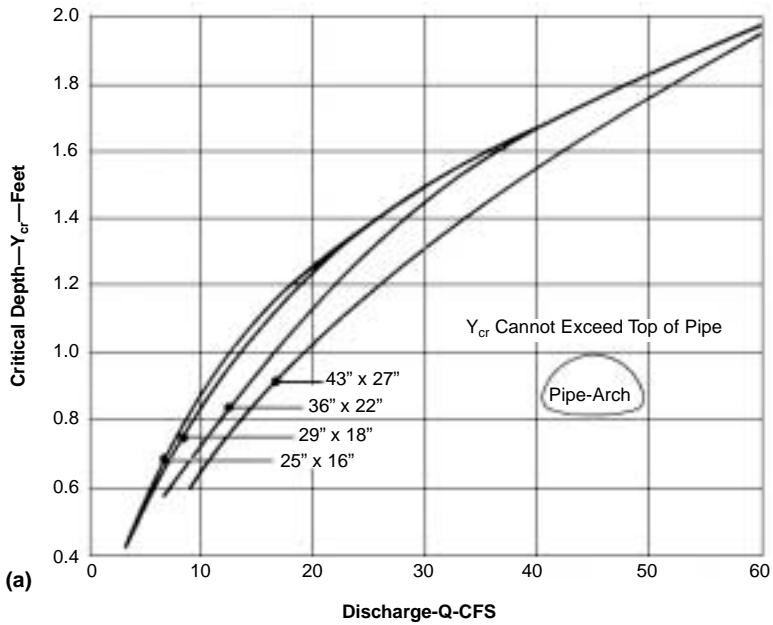


Figure 4.6 Critical depth curves for standard corrugated steel pipe (adapted from Federal Highway Administration)<sup>2</sup>.

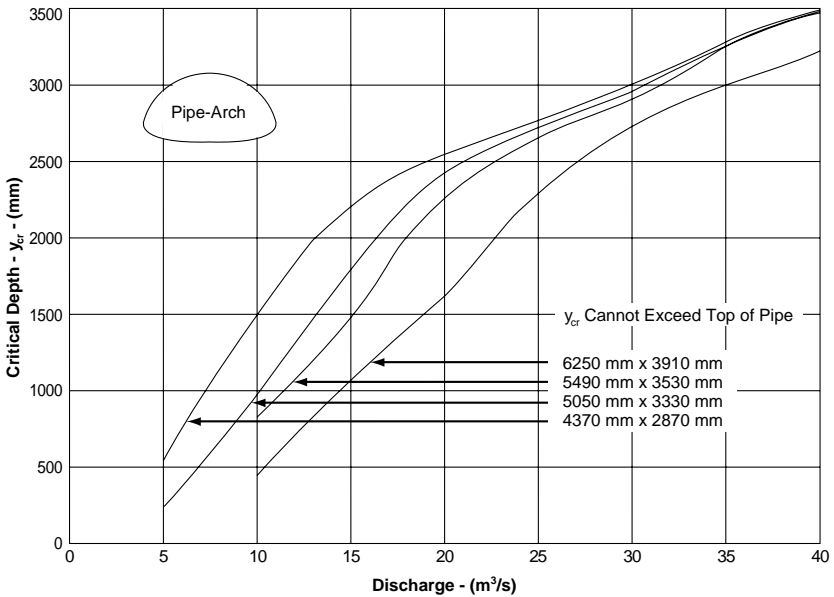
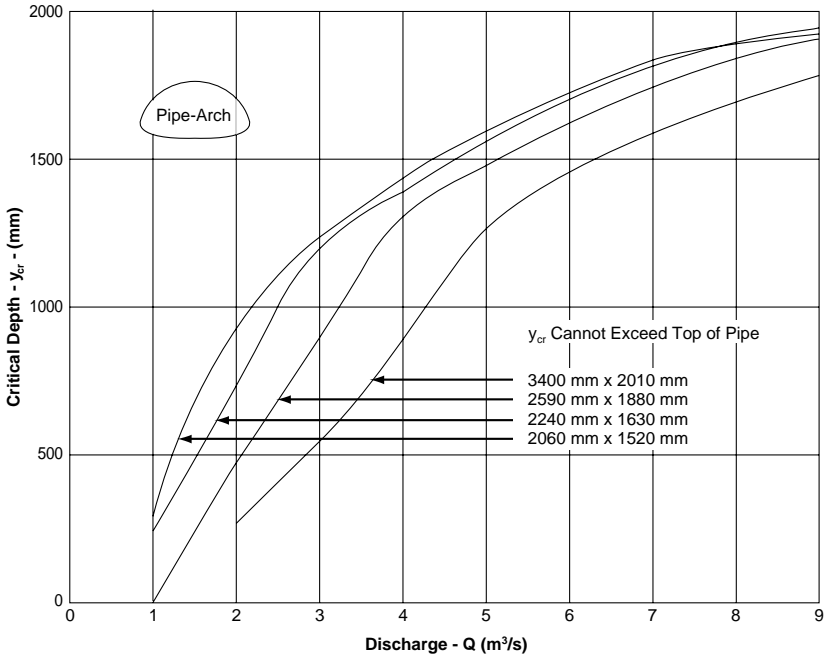
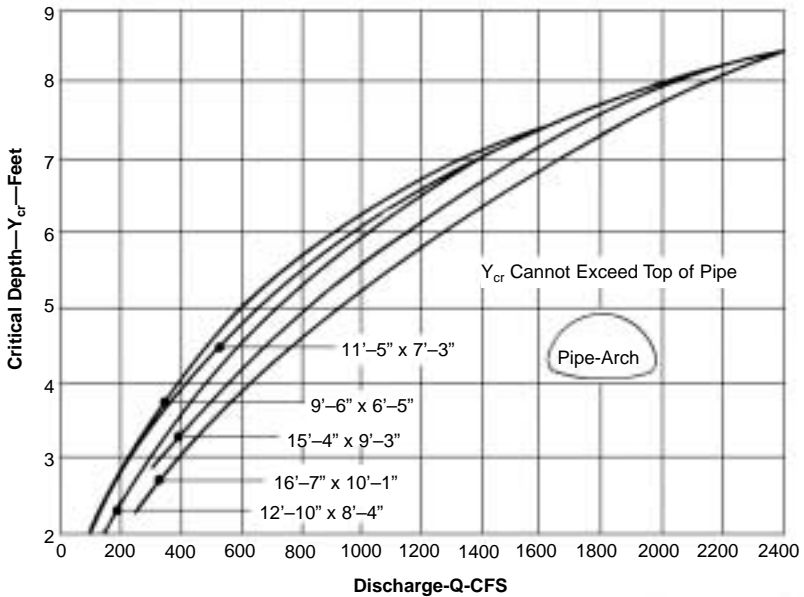
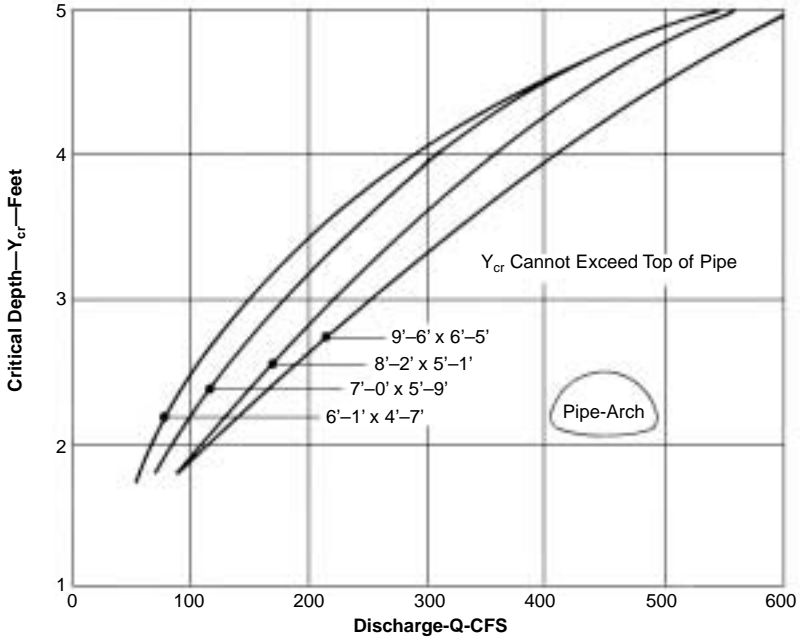


Figure 4.7M Critical depth curves for structural plate pipe-arch (adapted from Federal Highway Administration).



**Figure 4.7** Critical depth curves for structural plate pipe-arch (adapted from Federal Highway Administration).

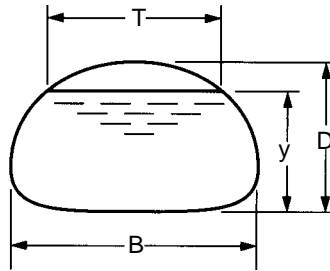
**Table 4.1M Waterway Areas for Standard Sizes of Corrugated Steel Conduits**

Round Pipe		Pipe-Arch (13 mm)		Structural Plate Pipe-Arch	
Diameter	Area	Size	Area	Size	Area
(mm)	(m <sup>2</sup> )	(mm)	(m <sup>2</sup> )	457 mm Corner Radius	
(mm)	(m <sup>2</sup> )	(mm)	(m <sup>2</sup> )	(mm)	(m <sup>2</sup> )
300	0.07	430 x 330	0.10	1850 x 1400	2.04
375	0.11	530 x 380	0.15	1930 x 1450	2.23
450	0.16	610 x 460	0.20	2060 x 1500	2.42
525	0.22	710 x 510	0.27	2130 x 1550	2.60
600	0.28	885 x 610	0.42	2210 x 1600	2.88
750	0.44	1060 x 740	0.60	2340 x 1650	3.07
900	0.64	1240 x 840	0.83	2410 x 1700	3.25
1050	0.87	1440 x 970	1.08	2490 x 1750	3.53
1200	1.13	1620 x 1100	1.37	2620 x 1800	3.72
1350	1.43	1800 x 1200	1.68	2690 x 1850	3.99
1500	1.77	1950 x 1320	2.03	2840 x 1910	4.27
1650	2.14	2100 x 1450	2.42	2900 x 2960	4.55
1800	2.54			2970 x 2010	4.83
1950	2.99			3120 x 2060	5.11
2100	3.46	Pipe-Arch (25 mm Corrugation)		3250 x 2110	5.39
2250	3.98	Size	Area	3330 x 2160	5.67
2400	4.52			3480 x 2210	5.95
2550	5.11	1520 x 1170	1.45	3530 x 2260	6.22
2700	5.73	1670 x 1300	1.79	3610 x 2310	6.60
2850	6.38	1850 x 1400	2.16	3760 x 2360	6.87
3000	7.07	2050 x 1500	2.56	3810 x 2360	7.25
3150	7.79	2200 x 1620	2.98	3810 x 2410	7.25
3300	8.55	2400 x 1720	3.44	3860 x 2460	7.53
3450	9.35	2600 x 1820	3.94	3910 x 2540	7.90
3600	10.18	2840 x 1920	4.46	4090 x 2570	8.27
3825	11.52	2970 x 2020	5.04	4240 x 2620	8.64
3980	12.47	3240 x 2120	5.62	4290 x 2670	9.01
4135	13.46	3470 x 2220	6.26	4340 x 2720	9.38
4290	14.49	3600 x 2320	6.92	4520 x 2770	9.75
4445	15.56			4670 x 2820	10.12
4600	16.66			4720 x 2870	10.50
4755	17.81	Structural Plate Arch		4780 x 2920	10.96
4910	18.99	Size	Area	4830 x 3000	11.33
5065	20.20	1830 x 970	1.39	5000 x 3020	11.71
5220	21.46	2130 x 1120	1.86	5050 x 3070	12.17
5375	22.75	2440 x 1270	2.42		
5530	24.08	2740 x 1440	3.07	787 mm Corner Radius	
5685	25.46	3050 x 1600	3.81	4040 x 2840	9.0
5840	26.86	3350 x 1750	4.65	4110 x 2900	9.5
5995	28.31	3660 x 1910	5.48	4270 x 2950	9.8
6150	29.79	3960 x 2060	6.50	4320 x 3000	10.1
6305	31.31	4270 x 2210	7.43	4390 x 3050	10.6
6460	32.87	4570 x 2360	8.55	4550 x 3100	11.0
6615	34.47	4880 x 2510	9.75	4670 x 3150	11.4
6770	36.10	5180 x 2690	11.06	4750 x 3200	11.8
6925	37.77	5490 x 2720	11.71	4830 x 3250	12.3
7080	39.48	5790 x 2880	13.01	4950 x 3300	12.7
7235	41.23	6100 x 3050	14.59	5030 x 3350	13.2
7390	43.01	6400 x 3200	15.98	5180 x 3400	13.6
7545	44.84	6710 x 3350	17.65	5230 x 3450	14.0
7700	46.70	7010 x 3510	19.32	5310 x 3510	14.6
7855	48.60	7320 x 3660	21.00	5460 x 3560	15.0
8010	50.53	7620 x 3810	22.95	5510 x 3610	15.5
				5660 x 3660	16.0
				5720 x 3710	16.4
				5870 x 3760	16.9
				5940 x 3810	17.5
				5990 x 3860	18.0
				6070 x 3910	18.6
				6220 x 3960	19.0
				6270 x 4010	19.6



### Hydraulic Properties of Pipe Arch Conduits Flowing Part Full

$y$  = Depth of flow  
 $D$  = Rise of conduit  
 $B$  = Span of conduit  
 $A$  = Area of flow  
 $R$  = Hydraulic radius  
 $T$  = Top width of flow



**Table 4.2 Determination of Area** Values of  $\frac{A}{BD}$

	.00	.01	.02	.03	.04	.05	.06	.07	.08	.09
.1		.072	.081	.090	.100	.109	.119	.128	.138	.148
.2	.157	.167	.177	.187	.197	.207	.217	.227	.237	.247
.3	.257	.267	.277	.287	.297	.307	.316	.326	.336	.346
.4	.356	.365	.375	.385	.394	.404	.413	.423	.432	.442
.5	.451	.460	.470	.479	.488	.497	.506	.515	.524	.533
.6	.541	.550	.559	.567	.576	.584	.592	.600	.608	.616
.7	.624	.632	.640	.647	.655	.662	.670	.677	.684	.690
.8	.697	.704	.710	.716	.722	.728	.734	.740	.745	.750
.9	.755	.760	.764	.769	.772	.776	.780	.783	.785	.787
1.0	.788									

**Table 4.3 Determination of Hydraulic Radius** Values of  $\frac{R}{D}$

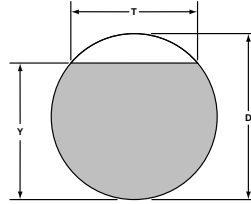
	.00	.01	.02	.03	.04	.05	.06	.07	.08	.09
.1		.078	.086	.094	.102	.110	.118	.126	.133	.141
.2	.148	.156	.163	.170	.177	.184	.191	.197	.204	.210
.3	.216	.222	.228	.234	.240	.245	.250	.256	.261	.266
.4	.271	.275	.280	.284	.289	.293	.297	.301	.305	.308
.5	.312	.315	.319	.322	.325	.328	.331	.334	.337	.339
.6	.342	.344	.346	.348	.350	.352	.354	.355	.357	.358
.7	.360	.361	.362	.363	.363	.364	.364	.365	.365	.365
.8	.365	.365	.364	.364	.363	.362	.361	.360	.359	.357
.9	.355	.353	.350	.348	.344	.341	.337	.332	.326	.318
1.0	.299									

**Table 4.4 Determination of Top Width** Values of  $\frac{T}{B}$

	.00	.01	.02	.03	.04	.05	.06	.07	.08	.09
.1		.900	.914	.927	.938	.948	.956	.964	.971	.976
.2	.982	.986	.990	.993	.995	.997	.998	.998	.998	.999
.3	.997	.996	.995	.993	.991	.989	.987	.985	.982	.979
.4	.976	.971	.967	.964	.960	.956	.951	.947	.942	.937
.5	.932	.927	.921	.916	.910	.904	.897	.891	.884	.877
.6	.870	.863	.855	.847	.839	.830	.822	.813	.803	.794
.7	.784	.773	.763	.752	.741	.729	.717	.704	.691	.678
.8	.664	.649	.634	.618	.602	.585	.567	.548	.528	.508
.9	.486	.462	.437	.410	.381	.349	.313	.272	.223	.158

**HYDRAULIC PROPERTIES OF CIRCULAR CONDUITS FLOWING PART FULL**

- D = Diameter
- y = Depth of flow
- A = Area of flow
- R = Hydraulic radius
- T = Top width



**Table 4.5 Determination of Area**

Values of  $\frac{A}{D^2}$

	.00	.01	.02	.03	.04	.05	.06	.07	.08	.09
.0	.000	.001	.004	.007	.011	.015	.019	.024	.029	.035
.1	.041	.047	.053	.060	.067	.074	.081	.089	.096	.104
.2	.112	.120	.128	.136	.145	.154	.162	.171	.180	.189
.3	.198	.207	.217	.226	.236	.245	.255	.264	.274	.284
.4	.293	.303	.313	.323	.333	.343	.353	.363	.373	.383
.5	.393	.403	.413	.423	.433	.443	.453	.462	.472	.482
.6	.492	.502	.512	.521	.531	.540	.550	.559	.569	.578
.7	.587	.596	.605	.614	.623	.632	.640	.649	.657	.666
.8	.674	.681	.689	.697	.704	.712	.719	.725	.732	.738
.9	.745	.750	.756	.761	.766	.771	.775	.779	.782	.784
1.0	.785									

**Table 4.6 Determination of Hydraulic Radius**

Values of  $\frac{R}{D}$

	.00	.01	.02	.03	.04	.05	.06	.07	.08	.09
.0	.000	.007	.013	.020	.026	.033	.039	.045	.051	.057
.1	.063	.070	.075	.081	.087	.093	.099	.104	.110	.115
.2	.121	.126	.131	.136	.142	.147	.152	.157	.161	.166
.3	.171	.176	.180	.185	.189	.193	.198	.202	.206	.210
.4	.214	.218	.222	.226	.229	.233	.236	.240	.243	.247
.5	.250	.253	.256	.259	.262	.265	.268	.270	.273	.275
.6	.278	.280	.282	.284	.286	.288	.290	.292	.293	.295
.7	.296	.298	.299	.300	.301	.302	.302	.303	.304	.304
.8	.304	.304	.304	.304	.304	.303	.303	.302	.301	.299
.9	.298	.296	.294	.292	.289	.286	.283	.279	.274	.267
1.0	.250									

**Table 4.7 Determination of Top Width**

Values of  $\frac{T}{D}$

	.00	.01	.02	.03	.04	.05	.06	.07	.08	.09
.0	.000	.199	.280	.341	.392	.436	.475	.510	.543	.572
.1	.600	.626	.650	.673	.694	.714	.733	.751	.768	.785
.2	.800	.815	.828	.842	.854	.866	.877	.888	.898	.908
.3	.917	.925	.933	.940	.947	.954	.960	.966	.971	.975
.4	.980	.984	.987	.990	.993	.995	.997	.998	.999	1.000
.5	1.000	1.000	.999	.998	.997	.995	.993	.990	.987	.984
.6	.980	.975	.971	.966	.960	.954	.947	.940	.933	.925
.7	.917	.908	.898	.888	.877	.866	.854	.842	.828	.815
.8	.800	.785	.768	.751	.733	.714	.694	.673	.650	.626
.9	.600	.572	.543	.510	.475	.436	.392	.341	.280	.199
1.0	.000									

i.e.: Given  $y = 300$  mm,  $D = 400$  mm,  $\frac{y}{D} = 0.75$  From tables;  $\frac{A}{D^2} = 0.632$ ,  $\frac{R}{D} = 0.302$ ,  $\frac{T}{D} = 0.866$

(or velocity). Both equations use an empirical coefficient 'n' to describe the roughness of the channel boundary. Tables 4.9 and 4.10 give suggested values for 'n' for various corrugation profiles and linings.

### Manning Equation

The Manning Equation is one of a number of so-called empirical equations. It is widely used in open channel flow but can also be applied to closed conduit flow. The equation is not dimensionally homogeneous and a correction factor must be applied depending upon the system of units being used.

$$V = (M/n) R^{2/3} S_f^{1/2}$$

Where V = average velocity

M = 1 for SI units (1.486 for US Imperial Units)

R = hydraulic radius = A/P, m (ft)

A = cross-sectional area, m<sup>2</sup> (ft<sup>2</sup>)

**Table 4.8 Effective Absolute Roughness and Friction Formula Coefficients<sup>3</sup>**

Conduit Material	Manning n
<b>Closed conduits</b>	
Asbestos-cement pipe	0.011-0.015
Brick	0.013-0.017
Cast iron pipe	
Uncoated (new)	—
Asphalt dipped (new)	—
Cement-lined & seal coated	0.011-0.015
Concrete (monolithic)	
Smooth forms	0.012-0.014
Rough forms	0.015-0.017
Concrete pipe	0.011-0.015
Plastic pipe (smooth)	0.011-0.015
Vitrified clay	
Pipes	0.011-0.015
Liner plates	0.013-0.017
<b>Open channels</b>	
Lined channels	
a. Asphalt	0.013-0.017
b. Brick	0.012-0.018
c. Concrete	0.011-0.020
d. Rubble or riprap	0.020-0.035
e. Vegetal	0.030-0.400
Excavated or dredged	
Earth, straight and uniform	0.020-0.030
Earth, winding, fairly uniform	0.025-0.040
Rock	0.030-0.045
Unmaintained	0.050-0.140
Natural Channels (minor streams, top width at flood stage < 30m, 100 ft)	
Fairly regular section	0.030-0.0700
Irregular section with pools	0.040-0.100



**Table 4.9M Values of Coefficient of Roughness (n) for Standard Corrugated Steel Pipe (Manning's Formulas). All Dimensions in mm.**

Corrugations		Helical											Annular 68 mm				
		38 x 6.5			68 x 13												
Flowing:	Diameters	200	250	300	375	450	600	750	900	1050	1200	1350 & Larger					
Full Unpaved		0.012	0.014	0.011	0.012	0.013	0.015	0.017	0.018	0.019	0.020	0.021		0.024			
Full 25% Paved							0.014	0.016	0.017	0.018	0.020	0.019		0.021			
Part Full Unpaved				0.012	0.013	0.015	0.017	0.019	0.020	0.021	0.022	0.023		0.027			
Flowing:	Pipe-Arch				430 x 330	530 x 380	710 x 510	885 x 610	1060 x 740	1240 x 840	1440 x 970	1620 x 1100 & Larger					
Full Unpaved					0.013	0.014	0.016	0.018	0.019	0.020	0.021	0.022			0.026		
Part Full					0.018	0.019	0.021	0.023	0.024	0.025	0.025	0.026			0.029		
		Helical											Annular 75 x 25				
		75 x 25															
Flowing:									900	1050	1200	1350	1500	1650	1800	1950 & Larger	
Full Unpaved									0.022	0.022	0.023	0.023	0.024	0.025	0.026	0.027	0.027
25% Paved									0.019	0.019	0.020	0.020	0.021	0.022	0.022	0.023	0.023
		Helical											Annular 125 x 25				
		125 x 25															
Flowing:										1200	1350	1500	1650	1800	1950 & Larger		
Full Unpaved										0.022	0.022	0.023	0.024	0.024	0.025	0.025	
25% Paved										0.019	0.019	0.020	0.021	0.021	0.022	0.022	
All pipe with smooth interior*		All Diameters 0.012															

**Notes:** Includes full paved, concrete lined, spiral rib and double wall pipe. Reference 13 modified for lower values of n for helical pipe.

**Table 4.9 Values of Coefficient of Roughness (n) for Standard Corrugated Steel Pipe (Manning's Formulas)**

Corrugations		Helical										Annular 2 <sup>2</sup> / <sub>3</sub> in.					
		1 <sup>1</sup> / <sub>2</sub> x 1 <sup>1</sup> / <sub>4</sub> in.		2 <sup>2</sup> / <sub>3</sub> x 1 <sup>1</sup> / <sub>2</sub> in.													
		8 in.	10 in.	12 in.	15 in.	18 in.	24 in.	30 in.	36 in.	42 in.	48 in.		54 in. and Larger				
Flowing:	Diameters																
Full Unpaved		0.012	0.014	0.011	0.012	0.013	0.015	0.017	0.018	0.019	0.020	0.021	0.024				
Full 25% Paved							0.014	0.016	0.017	0.018	0.020	0.019	0.021				
Part Full Unpaved				0.012	0.013	0.015	0.017	0.019	0.020	0.021	0.022	0.023	0.027				
Flowing:	Pipe-Arch				17 x 13	21 x 15	28 x 20	35 x 24	42 x 29	49 x 33	57 x 38	64 x 43 and Larger					
Full Unpaved					0.013	0.014	0.016	0.018	0.019	0.020	0.021	0.022	0.026				
Part Full					0.018	0.019	0.021	0.023	0.024	0.025	0.025	0.026	0.029				
		Helical										Annular 3 x 1 in.					
		3 x 1 in.															
Flowing:									36 in.	42 in.	48 in.	54 in.	60 in.	66 in.	72 in.	78 in. & Larger	
Full Unpaved									0.022	0.022	0.023	0.023	0.024	0.025	0.026	0.027	0.027
25% Paved									0.019	0.019	0.020	0.020	0.021	0.022	0.022	0.023	0.023
		Helical										Annular 5 x 1 in.					
		5 x 1 in.															
Flowing:										48 in.	54 in.	60 in.	66 in.	72 in.	78 in. & Larger		
Full Unpaved										0.022	0.022	0.023	0.024	0.024	0.025	0.025	
25% Paved										0.019	0.019	0.020	0.021	0.021	0.022	0.022	
All pipe with smooth interior*		All Diameters 0.012															

**Notes:** Includes full paved, concrete lined, spiral rib and double wall pipe. Reference 13 modified for lower values of n for helical pipe.

- P = wetted perimeter, m (ft)
- S<sub>f</sub> = friction gradient or slope of energy line
- n = Manning’s roughness coefficient (see Tables 4.8, 4.9, 4.10)

Figure 4.8 provides nomographs for estimating steady uniform flow for pipe flowing full, using the Manning equation. In cases where conduits are flowing only partly full, the corresponding hydraulic ratios may be determined from Figures 4.9 and 4.10.

**Kutter Equation**

The Kutter Equation is used for open channel calculations in certain areas of the United States. It is an empirically derived relation between the Chezy coefficient ‘C’ and the Manning roughness coefficient ‘n.’

$$Q = A \cdot C \cdot R^{1/2} \cdot S_f^{1/2}$$

where  $C = \frac{23 + \frac{0.00155}{S_f} + \frac{1}{n}}{1 + \frac{n}{\sqrt{R}} \left( 23 + \frac{0.00155}{S_f} \right)}$

Although the friction slope S<sub>f</sub> appears as a second order term in the expression for ‘C,’ the resulting discharge is not sensitive to this term. Table 4.11 shows the difference (%) in discharge computed using the Kutter equation compared with that obtained by Manning. The table gives the relationship between the diameter (D) and the hydraulic radius (R) assuming full flow in a circular pipe. The values in Table 4.11 are also valid for noncircular pipes flowing partially full.

The two equations give identical results for values of R close to 1.0 m (3 ft), which represents a very large pipe of perhaps 3600 mm (144 in.) diameter. For smaller sized conduits, the difference is significant, especially where the roughness coefficient is large.

**Table 4.10M Values of n for Structural Plate Pipe for 152 x 51mm Corrugations (Manning’s Formula)**

Corrugations	Diameters			
152 x 51	1500	2120	3050	4600
(mm)	(mm)	(mm)	(mm)	(mm)
Plain – unpaved	0.033	0.032	0.030	0.028
25% Paved	0.028	0.027	0.026	0.024

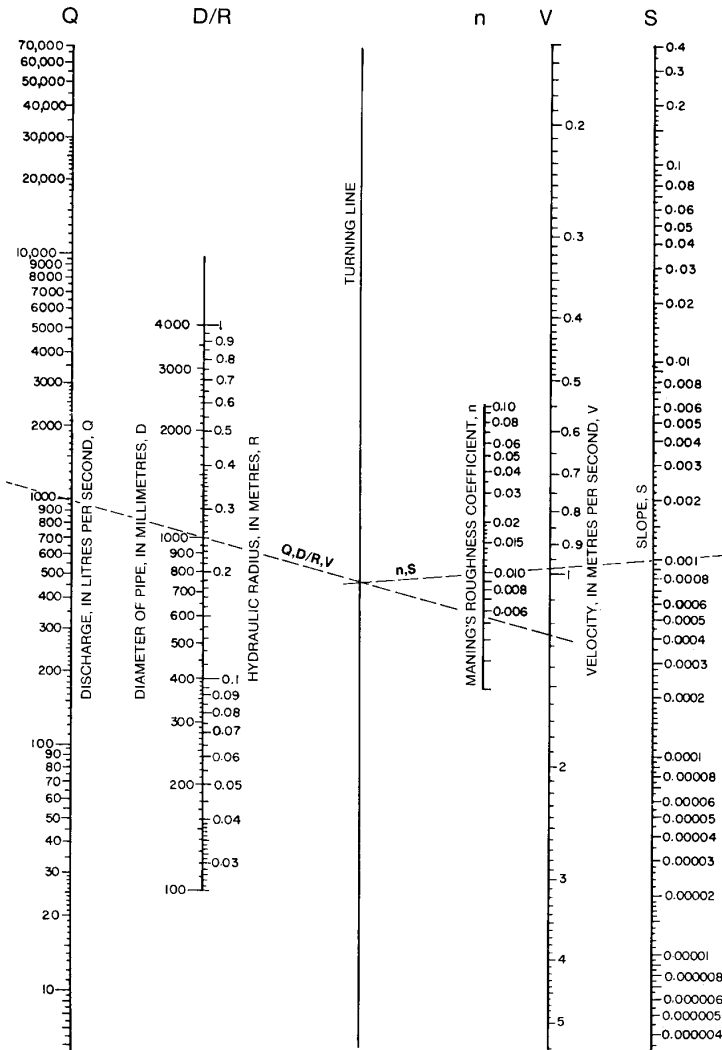
**Table 4.10 Values of n for Structural Plate Pipe for 6 x 2 in. Corrugations (Manning’s Formula)**

Corrugations	Diameters			
6 x 2 in.	5	7	10	15
	(ft)	(ft)	(ft)	(ft)
Plain – unpaved	0.033	0.032	0.030	0.028
25% Paved	0.028	0.027	0.036	0.024

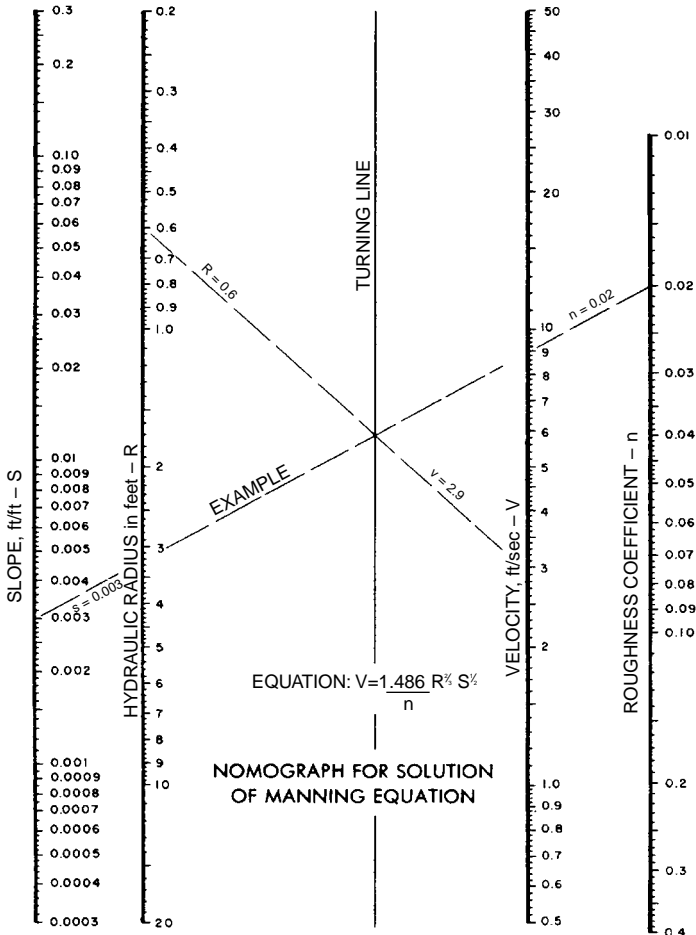
### Solving the Friction Loss Equation

Of the three quantities ( $Q$ ,  $S_f$ ,  $y_o$ ) of greatest interest in open channel analysis, the discharge  $Q$  and the friction slope  $S_f$  are easily obtained as they appear explicitly in the equations. Because of the exponential form of the Manning equation, it is a simple matter to compute the friction slope  $S_f$  as a function of velocity or discharge for known cross-sectional properties. Even with the Kutter equation, the second order term in  $S_f$  is of little importance and can be safely ignored as a first iteration when solving for  $S_f$ .

The third quantity is the normal depth  $y_o$ , which is the depth at which uniform flow would take place in a very long reach of channel. The normal depth is less easily determined as it appears in the expressions for both area  $A$  and hydraulic radius  $R$ .



**Note:** Use chart for flow computations,  $HL = S$ ; Alignment chart for energy loss in pipes, for Manning's formula.  
**Figure 4.8M** Nomograph for solution of Manning's formula.



**Note:** Use chart for flow computations,  $HL = S$ ; Alignment chart for energy loss in pipes, for Manning's formula. **Figure 4.8** Nomograph for solution of Manning's formula.

A trial and error solution is required except for sections of straightforward geometry.

For partially-full circular channels, a convenient semi-graphical method of solution is provided by the curves describing proportional ratios of discharge, hydraulic radius, area and velocity expressed as a function of the relative depth  $y/D$ . Two simple examples should give an indication of how these curves can be used:

Example 1: Finding the normal depth  $y_0$ .

A pipe of diameter 1.0 m (3 ft) ( $n = 0.013$ ) has a gradient of 1.0%. It is required to find the normal depth  $y_0$  for a discharge of  $2 \text{ m}^3/\text{s}$  ( $40 \text{ ft}^3/\text{s}$ ).

Step 1: Calculate the full-pipe capacity using Manning's equation for

$D = 1050 \text{ mm}$  (assume 1 m) (36 in.)

For full-pipe flow  $R = D/4 = 0.25 \text{ m}$  (0.75 ft)

$Q = (1)^2 (0.25)^{2/3} (0.01)^{1/2} / 0.013 = 2.4 \text{ m}^3/\text{s}$  ( $66.7 \text{ ft}^3/\text{s}$ )

Step 2: Get the proportional discharge  $Q_{\text{act}}/Q_{\text{full}} = 2/2.4 = 0.83$  (0.6)

Step 3: From the 'Discharge' curve of Figure 4.10 find the corresponding proportional depth  $y/D = 0.68$  (0.56). Thus the normal depth is given by:  $y_0 = 0.68 \times 1 = 0.68 \text{ m}$  (1.68 ft)

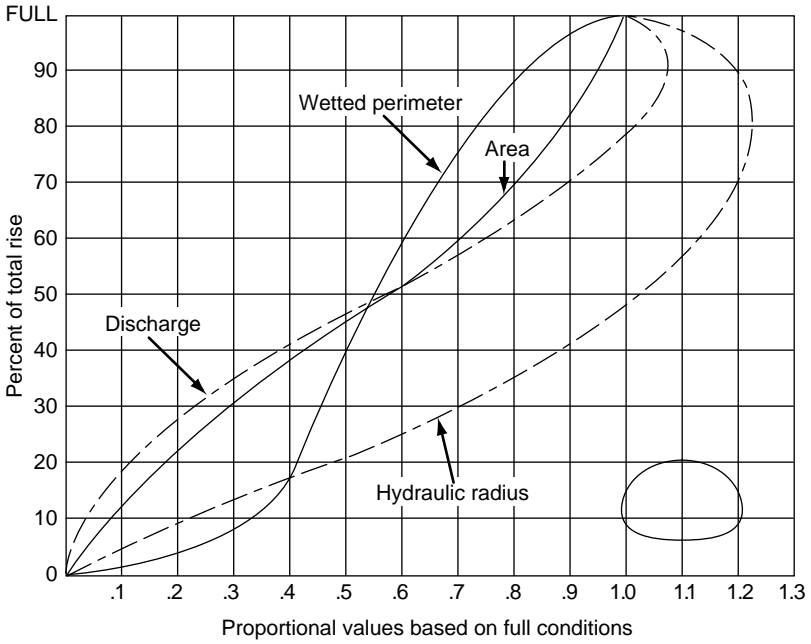


Figure 4.9 Hydraulic properties of corrugated steel and structural plate pipe-arches

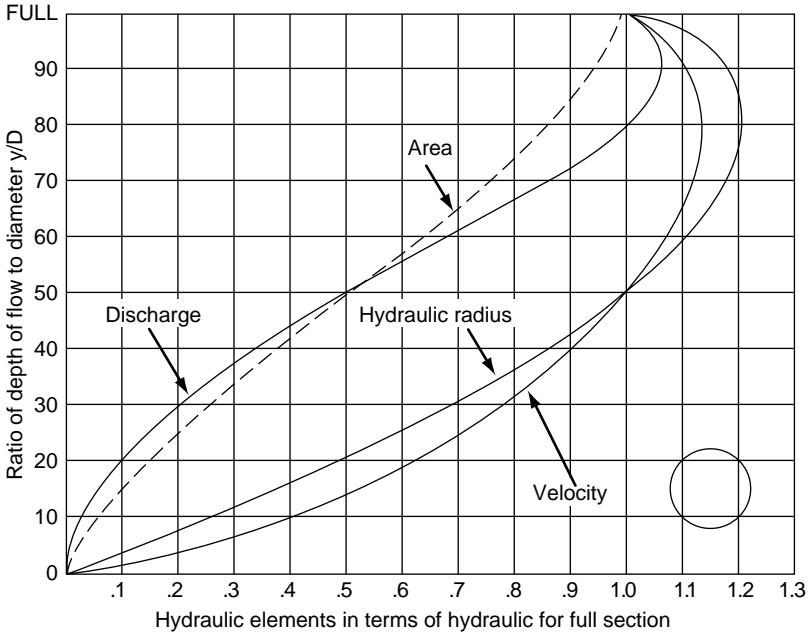


Figure 4.10 Hydraulic elements graph for circular CSP

**Table 4.11M Percent Difference of Kutter Equation Compared With Manning Equation (Grade = 1.0%)**

Diameter	Hydraulic Radius	n = 0.013	n = 0.02	n = 0.03
D-(m)	R-(m)			
0.5	0.125	-0.31	-5.50	-6.74
1.5	0.250	1.15	-2.20	-3.62
1.5	0.375	1.34	-0.96	-2.19
2.0	0.500	1.20	-0.38	-1.35
2.5	0.625	0.94	-0.11	-0.82
3.0	0.750	0.64	0.01	-0.45
3.5	0.875	0.32	0.03	-0.19
4.0	1.000	0.00	0.00	0.00
4.5	1.125	-0.32	-0.07	0.14
5.0	1.250	-0.62	-0.16	0.24
5.5	1.375	-0.92	-0.27	0.31
6.0	1.500	-1.21	-0.39	0.36

**Table 4.11 Percent Difference of Kutter Equation Compared With Manning Equation (Grade = 1.0%)**

Diameter	Hydraulic Radius	n = 0.013	n = 0.02	n = 0.03
D-(ft)	R-(ft)			
1.0	0.25	-4.46	-16.18	-26.13
2.0	0.50	-0.46	-8.54	-16.74
3.0	0.75	2.05	-5.07	-11.82
4.0	1.00	2.58	-3.12	-8.70
5.0	1.25	2.66	-1.94	-6.54
6.0	1.50	2.51	-1.18	-4.95
7.0	1.75	2.25	-0.70	-3.74
8.0	2.00	1.92	-0.39	-2.80
9.0	2.25	1.55	-0.20	-2.05
10.0	2.50	1.17	-0.10	-1.45
11.0	2.75	0.78	-0.06	-0.96
12.0	3.00	0.38	-0.07	-0.56
13.0	3.25	-0.01	-0.12	-0.23
14.0	3.50	-0.39	-0.19	0.04
15.0	3.75	-0.77	-0.28	0.26
16.0	4.00	-1.14	-0.39	0.44

Example 2: Designing for a range of flows.

A pipe is designed to carry a minimum discharge of 0.12 m<sup>3</sup>/s (4.24 ft<sup>3</sup>/s). With a velocity not less than 1.0 m/s (2.95 ft/s) and a maximum discharge 0.6 m<sup>3</sup>/s (21.2 ft<sup>3</sup>/s) without surcharging. Use the flattest gradient possible. (n = 0.013)

Step 1: Assuming  $Q_{\text{full}} = Q_{\text{max}} = 0.6$ ;  $Q_{\text{min}} / Q_{\text{full}} = 0.12 / 0.6 = 0.2$

Step 2: This corresponds to  $y/D = 0.31$ , which in turn corresponds to a proportional velocity of  $V_{\text{min}} / V_{\text{full}} = 0.78$  (Figure 4.9). Thus the full pipe velocity corresponding to  $V_{\text{min}} = 1.0$  m/s is given by:  $V_{\text{full}} = 1.0 / 0.78 = 1.28$  m/s (3.78 ft/s)

Step 3: Thus for full pipe flow the required section area is given by:  
 $A = Q_{\text{max}} / V_{\text{full}} = 0.6 / 1.28 = 0.47$  m<sup>2</sup> or  $D = (4A/\pi)^{1/2} = 0.77$  m (2.67 ft)

Step 4: Assuming that commercial sizes are available in increments of 100 mm (3 in.), the selected diameter must be rounded down (to ensure  $V_{\text{min}} > 1.0$  m/s) to 750 mm (2.5 ft)

Step 5: The necessary slope is then obtained from the Manning equation as

$$S_o = S_f = \frac{Q^2 n^2}{A^2 R^{4/3}}$$

where  $A = \pi D^2/4 = 0.38$  m<sup>2</sup> and  $R = D/4 = 0.175$  m (0.62 ft)

Thus the required grade is  $S_o = 0.0043$  or approximately 0.4%

**Surface Water Profiles**

Uniform flow is seldom attained except in very long reaches, free from any form of transition. Gradually varied flow occurs as a form of gentle transition from one stage of uniform flow to another, and non-uniform flow is found to be the rule rather than the exception.

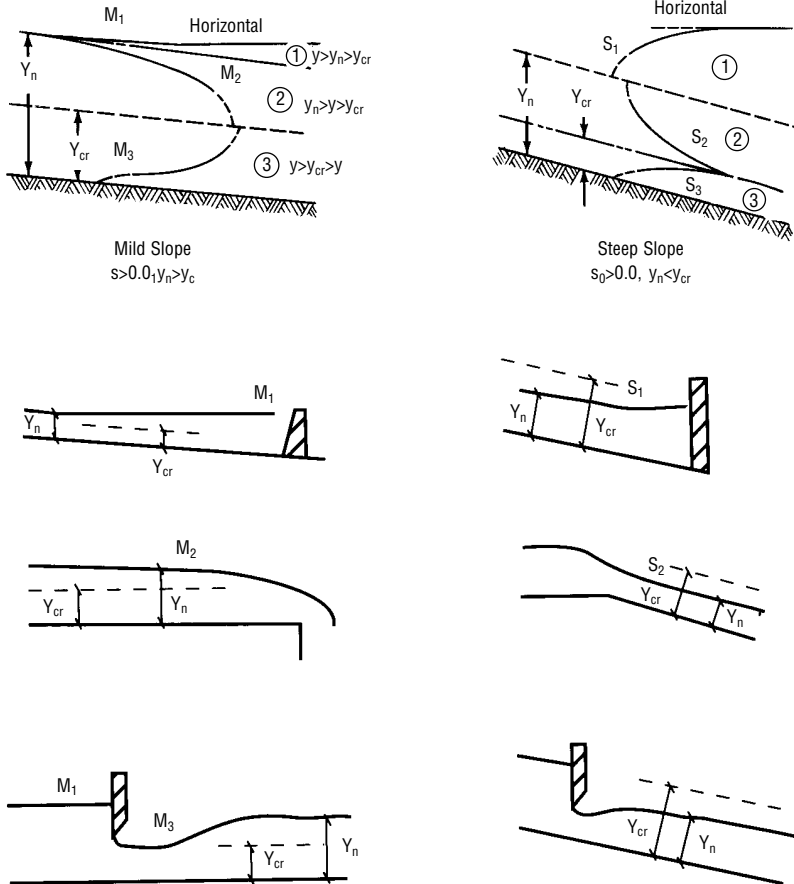
The flow profiles of gradually varied flow can be classified in relation to the normal depth  $y_o$  and the critical depth  $y_{cr}$  and the slope of the channel.

Channel slope is described as:

- (1) MILD when  $y_o > y_c$  i.e.  $S_o < S_c$ .
- (2) STEEP when  $y_o < y_{cr}$  i.e.  $S_o > S_c$ .

Note that the critical slope  $S_{cr}$  is slightly dependent on the stage or magnitude of flow, so that strictly speaking the description of Mild or Steep should not be applied to the channel without regard to the flow conditions.

Most textbooks show five classes of channel slope: Mild, Steep, Critical,



**Figure 4.11** Idealized flow profile.



Horizontal and Adverse. In practice, the last three categories are special cases of the first two and it is sufficient to consider them. In addition to the channel slope, a profile of gradually varied flow can be classified depending on whether it lies above, below or between the normal and critical depths. The three zones may be defined as follows.

Zone 1— Profile lies above both  $y_o$  and  $y_{cr}$

Zone 2— Profile lies between  $y_o$  and  $y_{cr}$

Zone 3— Profile lies below both  $y_o$  and  $y_{cr}$

Using the capitals ‘M’ and ‘S’ to denote Mild or Steep channel, state and the Zone number ‘1’, ‘2’ or ‘3’ profiles may be classified as ‘M<sub>1</sub>’ or ‘S<sub>3</sub>.’ Figure 4.11 shows the idealized cases of the six basic profile types along with typical circumstances in which they can occur.

### Hydraulic Jump

When supercritical flow enters a reach in which the flow is subcritical, an abrupt transition is formed that takes the form of a surface roller or undular wave, which tries to move upstream but is held in check by the velocity of the supercritical flow. Figure 4.12 shows a typical situation in which supercritical uniform flow from a steep reach enters a reach of mild slope in which the normal depth is subcritical.

The energy losses associated with the violent turbulence of the hydraulic jump make application of the Bernoulli equation impossible. Instead, the control volume of fluid containing the jump can be analyzed using the equation of conservation of momentum. For a prismatic channel of arbitrary cross-section, this can be expressed as follows:

$$Q^2/(g A_1) + A_1 y_1 = Q^2/(g A_2) + A_2 y_2$$

- where  $y$  = depth to the centroid of the cross-section
- $A$  = cross-sectional area
- $Q$  = total discharge
- $g$  = gravitational acceleration.

For the special case of a rectangular cross-section, the solution can be obtained directly using the discharge per unit breadth:

$$y_2 = - (y_1/2) + (y_1^2/4 + 2q^2/(gy_1))^{1/2}$$

- where  $y_2$  = depth downstream of the jump
- $y_1$  = depth upstream of the jump
- $q$  = discharge per unit breadth of channel
- $g$  = gravitational acceleration

The above equation is reversible so that  $y_1$  may be found as a function of  $y_2$  using a similar relationship.

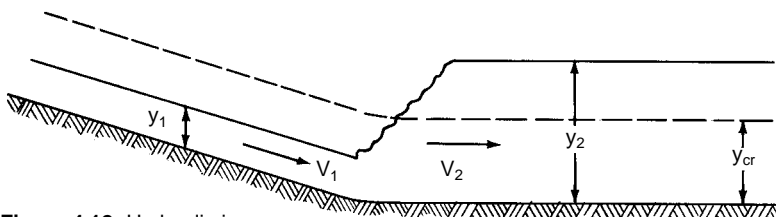


Figure 4.12 Hydraulic jump.

## FORM LOSSES IN JUNCTIONS, BENDS AND OTHER STRUCTURES

From the time storm water first enters the sewer system at the inlet until it discharges at the outlet, it will encounter a variety of hydraulic structures such as manholes, bends, contractions, enlargements and transitions, which will cause velocity head losses. These losses have been called "minor losses." This is misleading. In some situations these losses are as important as those arising from pipe friction. Velocity losses may be expressed in a general form derived from the Bernoulli and Darcy-Weisbach equations.

$$H = K \frac{V^2}{2g}$$

where H = velocity head loss  
 K = coefficient  
 V = average velocity  
 K = coefficient for the particular structure

The following are useful velocity head loss formulae of hydraulic structures commonly found in sewer systems. They are primarily based on experiments.

### Transition Losses (open channel)

The energy losses may be expressed in terms of the kinetic energy at the two ends:

$$H_t = K_t \Delta \left[ \frac{V^2}{2g} \right] \quad \text{where } K_t \text{ is the transition loss coefficient}$$

Contraction:

$$H_t = .1 \left( \frac{V_2^2}{2g} - \frac{V_1^2}{2g} \right) \quad V_2 > V_1$$

Expansion:

$$H_t = .2 \left( \frac{V_1^2}{2g} - \frac{V_2^2}{2g} \right) \quad V_1 > V_2$$

Where  $V_1$  = upstream velocity  
 $V_2$  = downstream velocity

Simple transition in size in a manhole with straight-through flow may be analyzed with the above equations.

### Transition Losses (pressure flow)

Contraction:

$$H_t = K \left( \frac{V_2^2}{2g} \right) \left[ 1 - \left( \frac{A_2}{A_1} \right) \right]^2$$

K = 0.5 for sudden contraction  
 K = 0.1 for well designed transition

and  $A_1, A_2$  = cross-sectional area of flow of incoming and outgoing pipe from transition.

Expansion:

$$H_t = K \left[ \frac{(V_1 - V_2)^2}{2g} \right]$$

K = 1.0 for sudden expansion

K = 0.2 for well designed transition

The above K values are for estimating purposes. If a more detailed analysis of the transition losses is required, then the tables in conjunction with the energy losses equation in the form below should be used for pressure flow.

$$H_t = K \left( \frac{V^2}{2g} \right)$$

**Entrance Losses**

$$H = K_e \frac{V^2}{2g}$$

**Table 4.12 Values of K<sub>2</sub> for Determining Loss of Head Due to Sudden Enlargement in Pipes, From the Formula H<sub>2</sub> = K<sub>2</sub> (V<sub>1</sub><sup>2</sup>/2g) <sup>7</sup>**

d<sub>2</sub>/d<sub>1</sub> = Ratio of Larger Pipe to Smaller Pipe                      V<sub>1</sub> = Velocity in Smaller Pipe

d <sub>2</sub> /d <sub>1</sub>	Velocity, V <sub>1</sub> , in Meters Per Second (feet per second)												
	0.6 (2.0)	0.9 (3.0)	1.2 (4.0)	1.5 (5.0)	1.8 (6.0)	2.1 (7.0)	2.4 (8.0)	3.0 (10)	3.6 (12)	4.5 (15)	6.0 (20)	9.0 (30)	12.0 (40)
1.2	.11	.10	.10	.10	.10	.10	.10	.09	.09	.09	.09	.09	.08
1.4	.26	.26	.25	.24	.24	.24	.24	.23	.23	.22	.22	.21	.20
1.6	.40	.39	.38	.37	.37	.36	.36	.35	.35	.34	.33	.32	.32
1.8	.51	.49	.48	.47	.47	.46	.46	.45	.44	.43	.42	.41	.40
2.0	.60	.58	.56	.55	.55	.54	.53	.52	.52	.51	.50	.48	.47
2.5	.74	.72	.70	.69	.68	.67	.66	.65	.64	.63	.62	.60	.58
3.0	.83	.80	.78	.77	.76	.75	.74	.73	.72	.70	.69	.67	.65
4.0	.92	.89	.87	.85	.84	.83	.82	.80	.79	.78	.76	.74	.72
5.0	.96	.93	.91	.89	.88	.87	.86	.84	.83	.82	.80	.77	.75
10.0	1.00	.99	.96	.95	.93	.92	.91	.89	.88	.86	.84	.82	.80
∞	1.00	1.00	.98	.96	.95	.94	.93	.91	.90	.88	.86	.83	.81

**Table 4.13 Values of K<sub>2</sub> for Determining Loss of Head Due to Gradual Enlargement in Pipes, From the Formula H<sub>2</sub> = K<sub>2</sub> (V<sub>1</sub><sup>2</sup>/2g) <sup>7</sup>**

d<sub>2</sub>/d<sub>1</sub> = Ratio of Diameter of Larger Pipe to Diameter of Smaller Pipe.  
 Angle of Cone is Twice the Angle Between the Axis of the Cone and its Side.

d <sub>2</sub> /d <sub>1</sub>	Angle of Cone													
	2°	4°	6°	8°	10°	15°	20°	25°	30°	35°	40°	45°	50°	60°
1.1	.01	.01	.01	.02	.03	.05	.10	.13	.16	.18	.19	.20	.21	.23
1.2	.02	.02	.02	.03	.04	.09	.16	.21	.25	.29	.31	.33	.35	.37
1.4	.02	.03	.03	.04	.06	.12	.23	.30	.36	.41	.44	.47	.50	.53
1.6	.03	.03	.04	.05	.07	.14	.26	.35	.42	.47	.51	.54	.57	.61
1.8	.03	.04	.04	.05	.07	.15	.28	.37	.44	.50	.54	.58	.61	.65
2.0	.03	.04	.04	.05	.07	.16	.29	.38	.46	.52	.56	.60	.63	.68
2.5	.03	.04	.04	.05	.08	.16	.30	.39	.48	.54	.58	.62	.65	.70
3.0	.03	.04	.04	.05	.08	.16	.31	.40	.48	.55	.59	.63	.66	.71
∞	.03	.04	.05	.06	.08	.16	.31	.40	.49	.56	.60	.64	.67	.72

**Table 4.14 Values of  $K_3$  for Determining Loss of Head Due to Sudden Contraction From the Formula  $H_3 = K_3(V_2^2/2g)$  <sup>7</sup>**

$d_2/d_1$ = Ratio of Larger Pipe to Smaller Pipe		$V_2$ = Velocity in Smaller Pipe											
		Velocity, $V_2$ , in Meters Per Second (feet per second)											
$d_2/d_1$	0.6 (2.0)	0.9 (3.0)	1.2 (4.0)	1.5 (5.0)	1.8 (6.0)	2.1 (7.0)	2.4 (8.0)	3.0 (10)	3.6 (12)	4.5 (15)	6.0 (20)	9.0 (30)	12.0 (40)
1.1	.03	.04	.04	.04	.04	.04	.04	.04	.04	.04	.05	.05	.06
1.2	.07	.07	.07	.07	.07	.07	.07	.08	.08	.08	.09	.10	.11
1.4	.17	.17	.17	.17	.17	.17	.17	.18	.18	.18	.18	.19	.20
1.6	.26	.26	.26	.26	.26	.26	.26	.26	.26	.25	.25	.25	.24
1.8	.34	.34	.34	.34	.34	.34	.33	.33	.32	.32	.31	.29	.27
2.0	.38	.38	.37	.37	.37	.37	.36	.36	.35	.34	.33	.31	.29
2.2	.40	.40	.40	.39	.39	.39	.39	.38	.37	.37	.35	.33	.30
2.5	.42	.42	.42	.41	.41	.41	.40	.40	.39	.38	.37	.34	.31
3.0	.44	.44	.44	.43	.43	.43	.42	.42	.41	.40	.39	.36	.33
4.0	.47	.46	.46	.46	.45	.45	.45	.44	.43	.42	.41	.37	.34
5.0	.48	.48	.47	.47	.47	.46	.46	.45	.45	.44	.42	.38	.35
10.0	.49	.48	.48	.48	.48	.47	.47	.46	.46	.45	.43	.40	.36
$\infty$	.49	.49	.48	.48	.48	.47	.47	.46	.46	.45	.44	.41	.38

### Manhole Losses

Manhole losses in many cases comprise a significant percentage of the overall losses within a sewer system. Consequently, if these losses are ignored, or underestimated, the sewer system may surcharge leading to basement flooding or sewer overflows. Losses at sewer junctions are dependent upon flow characteristics, junction geometry and relative sewer diameters. General problems with respect to flow through junctions have been discussed by Chow<sup>8</sup>, who concluded that the losses could be best estimated by experimental analysis as opposed to analytical procedures.

Marsalek<sup>9</sup>, in a study for three junction designs, found the following:

- In pressurized flow, the most important flow variable was the relative lateral inflow for junctions with more than two pipes. The losses increased as the ratio of the lateral discharge to main line discharge increased.
- Among the junction geometrical parameters, the important ones are: relative pipe sizes, junction benching and pipe alignment. Base shape and relative manhole sizes were less influential.
- Full benching to the crown of the pipe significantly reduced losses as compared to benching to the mid-section of the pipe or no benching.
- In junctions where two lateral inflows occurred, the head losses increased as the difference in flows between the two lateral sewers increased. The head loss was minimized when the lateral flows were equal.

Various experimental studies<sup>10,11,12,13,14,15</sup> have been performed to estimate manhole losses. These works should be referred to whenever possible. In cases where no applicable results are available, the following may be used as a guideline to estimate manhole losses.

**Manhole Losses (flow straight through)**

In a straight through manhole where there is no change in pipe size, losses can be estimated by:

$$H_m = 0.05 \frac{V^2}{2g}$$

**Terminal Manhole Losses**

Losses at terminal manholes may be estimated by the formula:

$$H_{tm} = \frac{V^2}{2g}$$

**Manhole Junction Losses**

Losses at junctions where one or more incoming laterals occur may be estimated by combining the laws of pressure plus momentum where  $H_j$  is equal to the junction losses.

$$H_j = K_j \frac{V^2}{2g}$$

using the laws of pressure plus momentum:

$$(H_j + D_1 - D_2) \frac{(A_1 + A_2)}{2} = \frac{Q_2^2}{A_2g} - \frac{Q_1^2}{A_1g} - \frac{Q_3^2}{A_3g} \cos \theta$$

**Bend Losses**

Bend losses may be estimated from the equation:

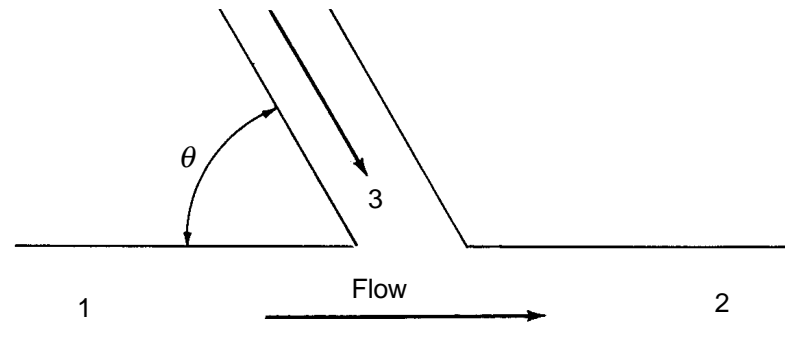
$$H_b = K_b \frac{V^2}{2g}$$

For curved sewer segments where the angle is less than 40° the bend loss coefficient may be estimated as:

$$H_m = .25 \sqrt{\frac{\varnothing}{90}}$$

where:  $\varnothing$  = central angle of bend in degrees

For greater angles of deflection and bends in manholes, the bend loss coefficient may be determined from Figure 4.13.



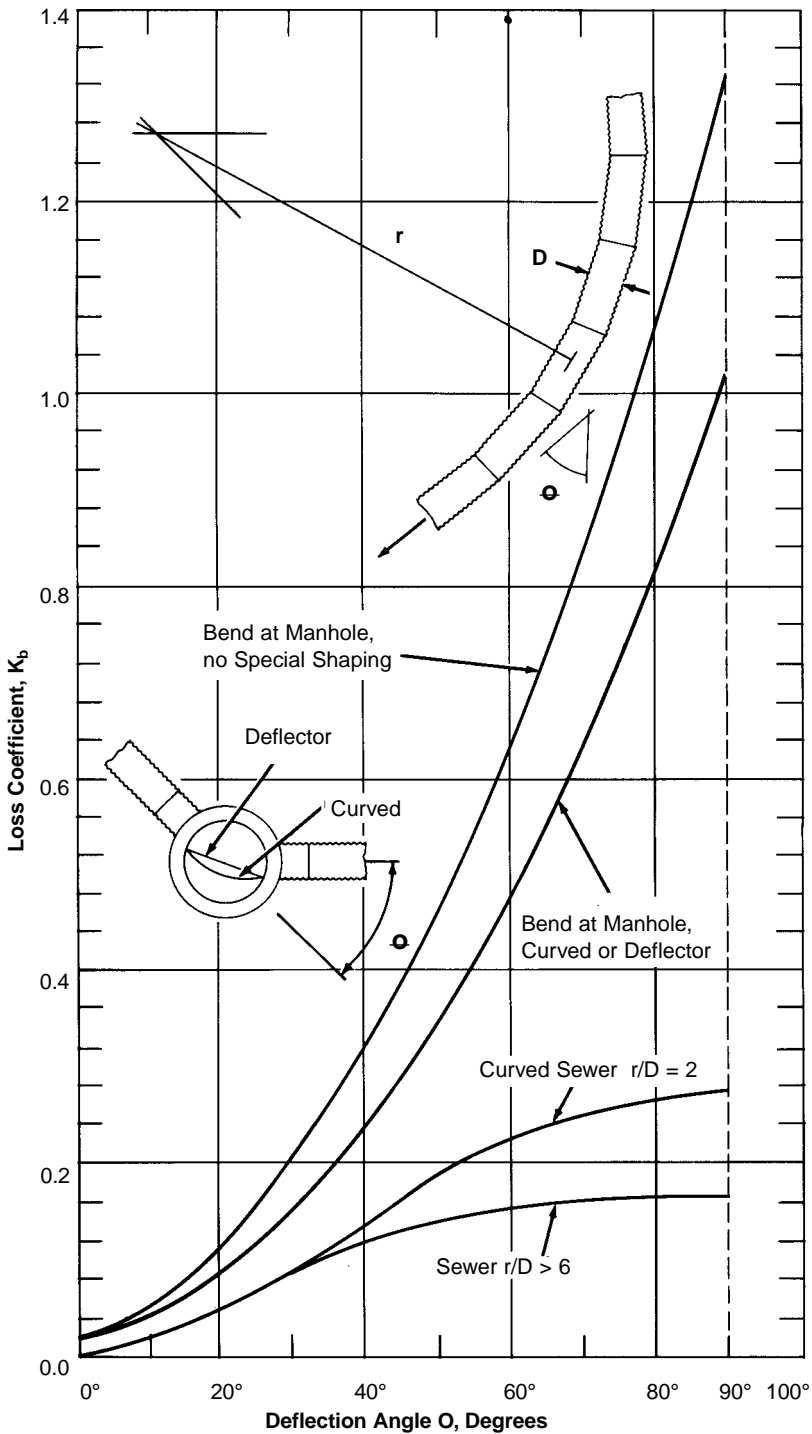


Figure 4.13 Sewer bend loss coefficient.<sup>16</sup>

## HYDRAULICS OF STORM INLETS

### Hydraulics of Storm Water Inlets

Storm water inlets are the means by which storm runoff enters the sewer system. Their design is often neglected or receives very little attention during the design of storm drainage systems. Inlets play an important role in road drainage and storm sewer design because of their effect on both the rate of water removal from the road surface and the degree of utilization of the sewer system. If inlets are unable to discharge the design inflow to the sewer system, it may result in a lower level of roadway convenience and conditions hazardous to traffic. It may also lead to overdesign of the sewer pipes downstream of the inlet. In some cases the limited capacity of the inlets may be desirable as a storm water management alternative thereby offering a greater level of protection from excessive sewer surcharging. In such cases, both the quantity of runoff intercepted and the resulting level of roadway convenience must be known. Furthermore, overdesign in the number of inlets results in higher costs and could result in overuse of the sewer system.

No one inlet type is best suited for all conditions. Many different types of inlets have thus been developed, as shown in Figure 4.17. In the past, the hydraulic capacities of some of these inlets were often unknown, sometimes resulting in erroneous capacity estimates.

Storm water inlets may not intercept all runoff due to the velocity of flow over the inlet and the spread of flow across the roadway and gutter. This leads to the concept of carryover flow. As carryover flow progresses downstream, it may accumulate, resulting in a greater demand for interception. It is imperative that more emphasis be placed on inlet design to assure that the inlet type, location and capacity are adequately determined to achieve the overall drainage requirements.

The hydraulic efficiency of inlets is a function of street grade, cross-slope, inlet geometry and curb and gutter design. Generally, an increased street cross-slope will result in increased inlet capacity as the flow is concentrated within the gutter. The depth of flow in the gutter may be estimated from Figure 4.14. The effect of street grades on inlet capacities varies. Initially as the street grade increases there is an increase in gutter flow velocity, which allows a greater flow to reach the inlets for interception. However, as street grades continue to increase, there is a threshold where the velocity is so high that less flow can be intercepted. This threshold velocity depends upon the geometry of the inlet and characteristics of the gutter, see Figures 4.15 and 4.16.

Recent experiments on inlet capacities<sup>17</sup> have resulted in a set of tables and charts to aid the designer in storm water inlet selection and sewer system design. A sample of the results is shown in Figures 4.15 and 4.16, Tables 4.16 and 4.17.

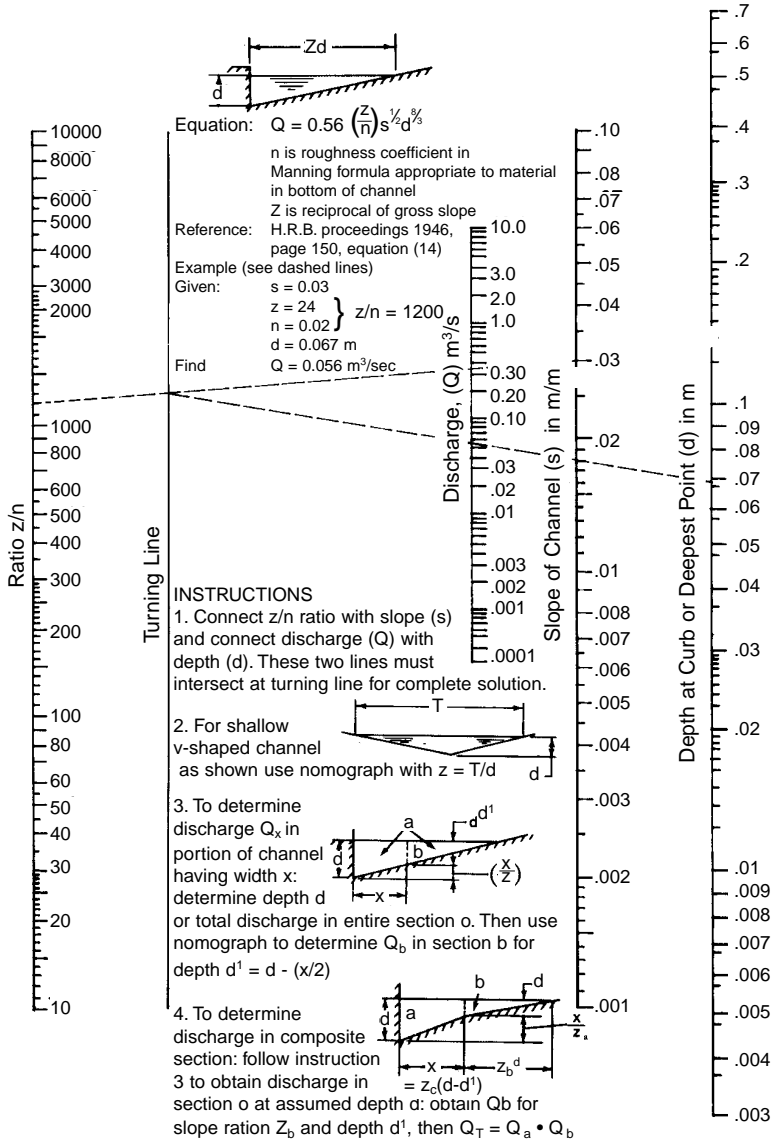
To use these charts or tables, the designer determines the overland flow and the resulting spread in gutter flow from a pre-determined road grade and crossfall, gutter design and inlet type; see Table 4.16. This value is then used with Table 4.17 to obtain the storm water inlet or grate inlet capacity. The difference between the flow on the roadway and the inlet capacity is referred to as the carryover. An illustrative example is presented below:

Design Parameter	— Road crossfall = 0.02 m/m (0.02 ft/ft)
	— Road grade = 0.02 m/m (0.02 ft/ft)
	— Gutter type B
	— Inlet grate type per Figure 4.16
	— One inlet on each side of the road
	— Upstream carryover flow = 0 m <sup>3</sup> /s
Catchment Runoff	= 0.18 m <sup>3</sup> /s (6.2 ft <sup>3</sup> /s)
Gutter Flow	= 0.18 ÷ 2 = 0.09 m <sup>3</sup> /s (3.1 ft <sup>3</sup> /s)

**Table 4.15 Entrance Loss Coefficients For Corrugated Steel Pipe or Pipe-Arch**

Inlet End of Culvert	Coefficient $K_e$
Projecting from fill (no headwall)	0.9
Headwall, or headwall and wingwalls square-edged	0.5
Mitered (beveled) to conform to fill slope	0.7
*End-Section conforming to fill slope	0.5
Headwall, rounded edge	0.2
Beveled Ring	0.25

**Notes:** \*End Sections available from manufacturers.



**Figure 4.14M** Nomograph for flow in triangular channels.



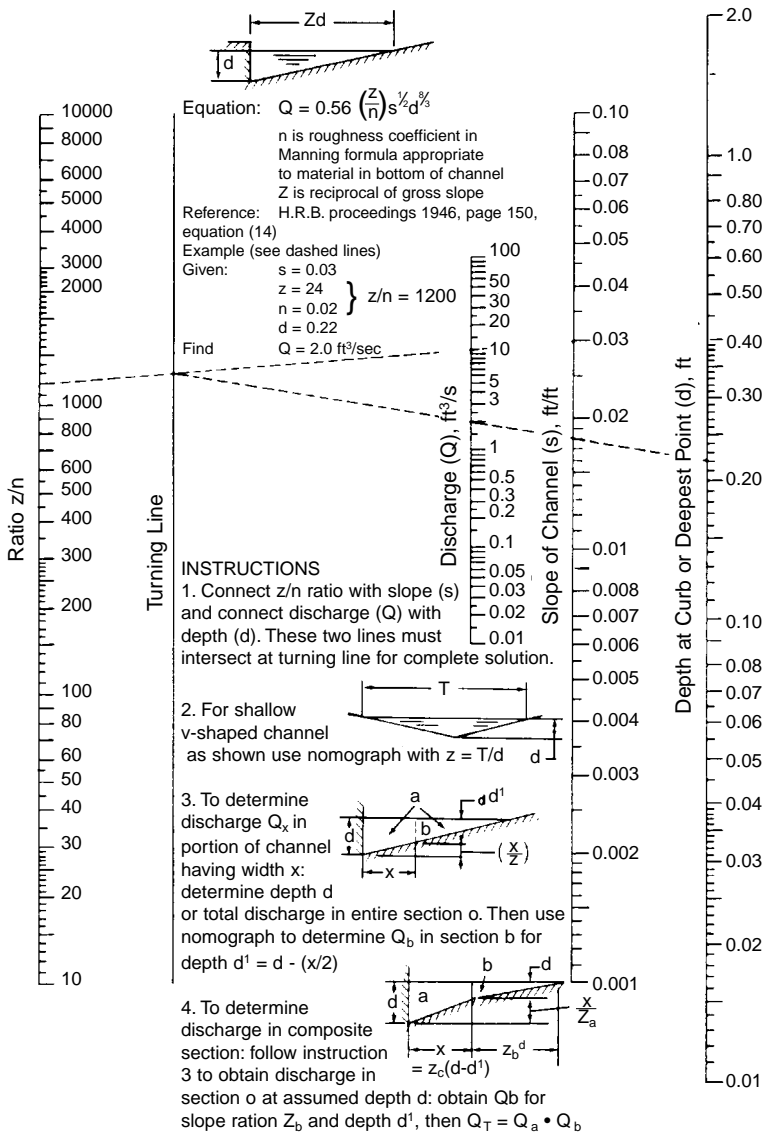


Figure 4.14 Nomograph for flow in triangular channels.

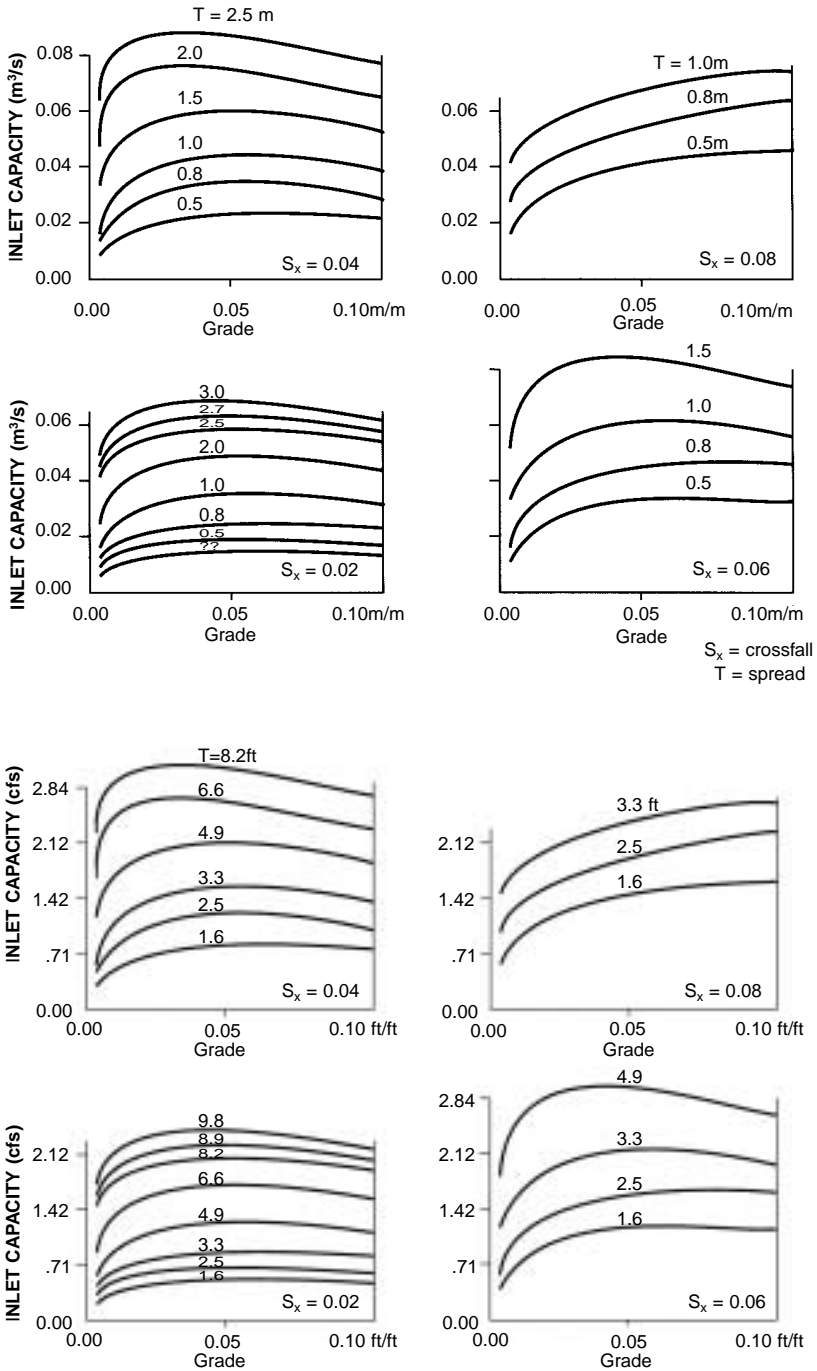


Figure 4.15 Sewer inlet capacity: as per curb and gutter in Figure 4.16

**Table 4.16M Gutter Flow Rate<sup>17</sup> (m<sup>3</sup>/s)**

Crossfall (m/m)	Spread (m)	Depth (m)	Grade (m/m)							
			0.003	0.01	0.02	0.03	0.04	0.06	0.08	0.10
0.02	0.00	0.05	0.005	0.008	0.012	0.014	0.016	0.020	0.023	0.026
	0.50	0.06	0.008	0.014	0.020	0.024	0.028	0.034	0.039	0.044
	0.75	0.06	0.010	0.018	0.025	0.031	0.036	0.044	0.051	0.057
	1.00	0.07	0.013	0.024	0.033	0.041	0.047	0.058	0.067	0.074
	1.50	0.08	0.022	0.039	0.055	0.068	0.078	0.096	0.110	0.123
	2.00	0.09	0.034	0.062	0.087	0.107	0.123	0.151	0.175	0.195
	2.50	0.10	0.051	0.093	0.131	0.161	0.186	0.227	0.263	0.294
	2.70	0.10	0.059	0.108	0.153	0.187	0.216	0.264	0.305	0.341
	3.00	0.11	0.073	0.134	0.189	0.231	0.267	0.327	0.378	0.422
	0.50	0.07	0.012	0.022	0.030	0.037	0.043	0.053	0.061	0.068
0.04	0.75	0.08	0.018	0.033	0.046	0.057	0.066	0.080	0.093	0.104
	1.00	0.09	0.026	0.048	0.068	0.084	0.097	0.118	0.136	0.153
	1.50	0.11	0.051	0.094	0.133	0.162	0.188	0.230	0.265	0.296
	2.00	0.13	0.089	0.163	0.230	0.281	0.325	0.398	0.460	0.514
	2.50	0.15	0.142	0.258	0.365	0.447	0.517	0.633	0.731	0.817
	0.50	0.08	0.017	0.031	0.043	0.053	0.061	0.075	0.087	0.097
	0.75	0.09	0.028	0.052	0.073	0.089	0.103	0.126	0.146	0.163
	1.00	0.11	0.044	0.080	0.114	0.140	0.161	0.197	0.228	0.255
	1.50	0.14	0.092	0.168	0.237	0.290	0.335	0.411	0.474	0.530
	1.67	0.15	0.113	0.206	0.292	0.358	0.413	0.506	0.584	0.653
0.06	0.50	0.09	0.023	0.042	0.059	0.072	0.083	0.102	0.117	0.131
	0.75	0.11	0.040	0.074	0.104	0.128	0.148	0.181	0.209	0.234
	1.00	0.13	0.065	0.120	0.169	0.207	0.239	0.293	0.338	0.378
	1.25	0.15	0.099	0.181	0.255	0.313	0.361	0.442	0.511	0.571

**Table 4.16 Gutter Flow Rate<sup>17</sup> (cfs)**

Crossfall (ft/ft)	Spread (ft)	Depth (ft)	Grade (ft/ft)							
			0.003	0.01	0.02	0.03	0.04	0.06	0.08	0.10
0.02	0.00	0.16	0.16	0.29	0.41	0.50	0.58	0.71	0.81	0.91
	1.64	0.20	0.27	0.49	0.69	0.84	0.98	1.19	1.38	1.54
	2.46	0.21	0.35	0.64	0.90	1.11	1.28	1.56	1.81	2.02
	3.28	0.23	0.46	0.83	1.18	1.44	1.66	2.04	2.35	2.63
	4.92	0.26	0.76	1.38	1.95	2.39	2.76	3.38	3.90	4.36
	6.56	0.30	1.19	2.18	3.08	3.78	4.36	5.34	6.17	6.89
	8.20	0.33	1.80	3.28	4.64	5.68	6.56	8.03	9.28	10.37
	8.86	0.34	2.09	3.81	5.39	6.60	7.62	9.34	10.78	12.05
	9.84	0.36	2.58	4.72	6.67	8.17	9.43	11.55	13.34	14.92
	1.64	0.23	0.41	0.76	1.07	1.31	1.51	1.86	2.14	2.39
0.04	2.46	0.26	0.64	1.16	1.64	2.01	2.32	2.84	3.28	3.66
	3.28	0.30	0.93	1.70	2.41	2.95	3.41	4.17	4.82	5.39
	4.92	0.36	1.81	3.31	4.69	5.73	6.63	8.11	9.37	10.47
	6.56	0.43	3.14	5.74	8.11	9.94	11.47	14.05	16.23	18.14
	8.20	0.49	5.00	9.12	12.90	15.80	18.24	22.34	25.80	28.84
	1.64	0.26	0.59	1.08	1.53	1.88	2.17	2.66	3.07	3.43
	2.46	0.31	1.00	1.82	2.58	3.15	3.64	4.46	5.15	5.76
	3.28	0.36	1.56	2.84	4.02	4.93	5.69	6.96	8.04	8.99
	4.92	0.46	3.24	5.92	8.37	10.25	11.84	14.50	16.75	18.72
	5.48	0.49	3.99	7.29	10.31	12.63	14.59	17.86	20.63	23.06
0.06	1.64	0.30	0.80	1.47	2.07	2.54	2.93	3.59	4.14	4.64
	2.46	0.36	1.43	2.61	3.69	4.52	5.22	6.39	7.38	8.25
	3.28	0.43	2.31	4.23	5.98	7.32	8.45	10.35	11.95	13.36
	4.10	0.49	3.49	6.38	9.02	11.05	12.76	15.62	18.04	20.17

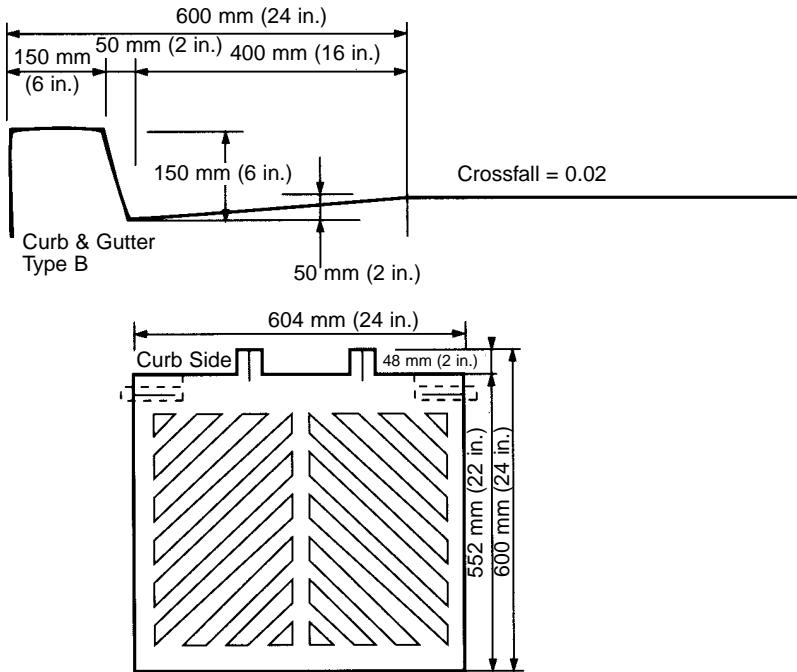


Figure 4.16 Catch basin grate.

Table 4.17M Grate Inlet Capacity<sup>17</sup> (m<sup>3</sup>/s)\*

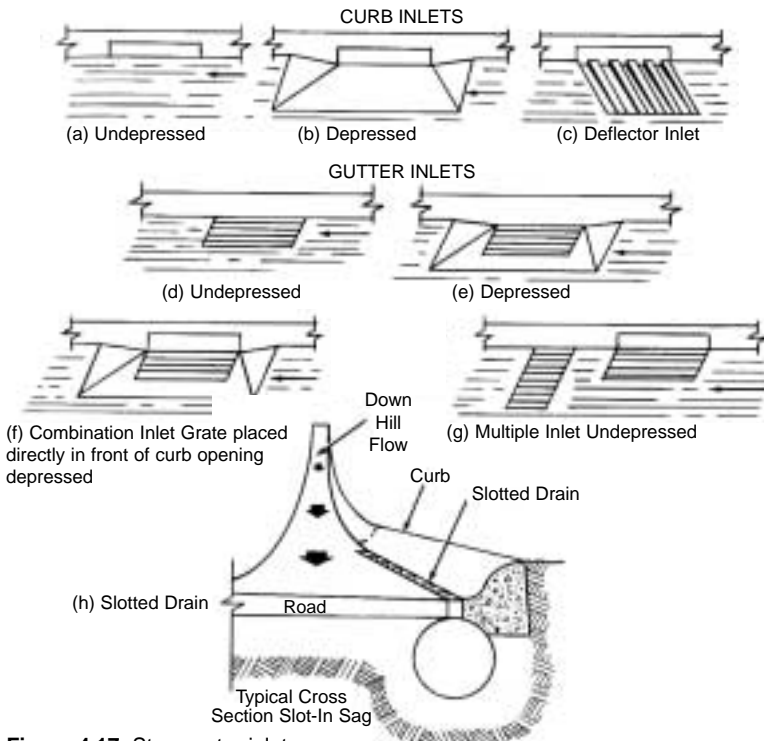
Crossfall (m/m)	Spread (m)	Grade (m/m)							
		0.00	0.01	0.02	0.03	0.04	0.06	0.08	0.10
0.02	0.50	0.005	0.007	0.010	0.011	0.012	0.012	0.013	0.012
	0.75	0.008	0.012	0.014	0.017	0.018	0.019	0.019	0.017
	1.00	0.010	0.014	0.018	0.021	0.022	0.023	0.024	0.022
	1.50	0.013	0.023	0.029	0.031	0.033	0.035	0.034	0.032
	2.00	0.023	0.035	0.040	0.043	0.044	0.044	0.043	0.041
	2.50	0.034	0.046	0.052	0.054	0.054	0.054	0.052	0.050
	2.70	0.037	0.050	0.056	0.057	0.058	0.057	0.056	0.052
	3.00	0.042	0.055	0.061	0.062	0.062	0.061	0.059	0.057
0.04	0.50	0.007	0.013	0.017	0.020	0.022	0.024	0.024	0.021
	0.75	0.012	0.021	0.027	0.030	0.031	0.032	0.031	0.028
	1.00	0.016	0.027	0.035	0.039	0.040	0.042	0.040	0.038
	1.50	0.027	0.046	0.054	0.057	0.058	0.056	0.053	0.050
	2.00	0.042	0.064	0.070	0.071	0.071	0.070	0.068	0.064
0.06	0.50	0.010	0.015	0.021	0.024	0.026	0.028	0.030	0.030
	0.75	0.019	0.028	0.033	0.036	0.039	0.042	0.044	0.043
	1.00	0.030	0.042	0.048	0.052	0.054	0.056	0.055	0.051
	1.50	0.048	0.062	0.069	0.071	0.072	0.071	0.068	0.063
	0.50	0.013	0.023	0.029	0.032	0.035	0.038	0.038	0.038
0.08	0.75	0.027	0.038	0.042	0.046	0.049	0.054	0.057	0.057
	1.00	0.038	0.050	0.047	0.061	0.063	0.068	0.072	0.074

Notes: \*Grate shown in Figure 4.16.

**Table 4.17** Grate Inlet Capacity<sup>17</sup> (cfs)\*

Crossfall (ft/ft)	Spread (ft)	Grade (ft/ft)								
		0.00	0.01	0.02	0.03	0.04	0.06	0.08	0.10	
0.02	1.64	0.17	0.26	0.34	0.39	0.41	0.44	0.45	0.43	
	2.46	0.28	0.41	0.50	0.59	0.63	0.66	0.68	0.61	
	3.28	0.36	0.51	0.64	0.74	0.79	0.82	0.83	0.77	
	4.92	0.46	0.80	1.01	1.11	1.18	1.22	1.21	1.13	
	6.56	0.81	1.25	1.42	1.53	1.55	1.54	1.51	1.45	
	8.20	1.21	1.63	1.84	1.92	1.92	1.89	1.83	1.75	
	8.86	1.29	1.77	1.97	2.03	2.04	2.02	1.96	1.84	
	9.84	1.48	1.94	2.14	2.19	2.18	2.14	2.09	2.02	
	1.64	0.24	0.45	0.60	0.69	0.76	0.84	0.83	0.75	
0.04	2.46	0.43	0.74	0.96	1.07	1.11	1.14	1.10	0.99	
	3.28	0.55	0.96	1.22	1.36	1.41	1.47	1.42	1.34	
	4.92	0.97	1.63	1.90	2.01	2.04	1.98	1.87	1.77	
	6.56	1.48	2.27	2.46	2.50	2.51	2.47	2.39	2.25	
	8.20	2.03	2.75	2.85	2.85	2.82	2.70	2.59	2.54	
	1.64	0.34	0.54	0.74	0.86	0.93	0.99	1.07	1.06	
	0.06	2.46	0.66	0.99	1.16	1.27	1.39	1.50	1.57	1.53
		3.28	1.07	1.49	1.69	1.83	1.90	1.96	1.94	1.80
		4.92	1.69	2.19	2.43	2.52	2.56	2.52	2.40	2.21
1.64		0.46	0.81	1.04	1.14	1.24	1.33	1.35	1.34	
0.08	2.46	0.96	1.33	1.49	1.61	1.73	1.89	2.00	2.02	
	3.28	1.34	1.78	1.65	2.15	2.24	2.41	2.55	2.63	

Notes: \*Grate shown in Figure 4.16.



**Figure 4.17** Stormwater inlets.

From Table 4.16 the resulting spread in flow = 2.00 m (6.56 ft). From Table 4.17, 2.00 m (6.56 ft) of spread results in an inlet capacity of 0.040 m<sup>3</sup>/s (1.42 ft<sup>3</sup>/s). Therefore, the total flow intercepted = 2 x 0.040 = 0.080 m<sup>3</sup>/s (2.84 ft<sup>3</sup>/s). The carryover flow = 0.18-0.08 = 0.10 m<sup>3</sup>/s (3.36 ft<sup>3</sup>/s).

For roads where few restrictions to inlet location may exist (i.e., highways and arterial roads), these charts can be used to establish minimum spacing between inlets. This is done by controlling the catchment area for each inlet. The area is simplified to a rectangular shape of width and length where the length represents the distance between inlets.

Under special circumstances, it may be necessary to install twin or double inlets to increase the inlet capacity. For reasons of interference by traffic, such installations are usually installed in series, parallel to the curb. Studies<sup>17</sup> have shown that where such installations exist on a continuous grade, the increases in inlet capacity rarely exceed 50 percent of the single inlet capacity.

The capacity of storm water inlets at a sag in the roadway is typically expressed by weir and orifice equations.<sup>18</sup> Flow into the inlets initially operates as a weir having a crest length equal to the length of perimeter that flow crosses. The inlet operates under these conditions to a depth of about 100 mm (4 in.). The quantity intercepted is expressed by the following:

$$Q = C \cdot L \cdot D^{1.5}$$

Where  $Q$  = rate of discharge into the grate opening

$$C = 1.66 \text{ for m}^3/\text{s} \text{ (3.0 for ft}^3/\text{s)}$$

$L$  = perimeter length of the grate, disregarding bars and neglecting the side against the curb, m (ft)

$D$  = depth of water at the grate, m (ft)

When the depth exceeds 0.12 m (0.4 ft), the inlet begins to operate as an orifice and its discharge is expressed by the following:

$$Q = C A D^{0.5}$$

Where  $Q$  = rate of discharge into the grate opening, m<sup>3</sup>/s (ft<sup>3</sup>/s)

$A$  = clear opening of the grate, m<sup>2</sup> (ft<sup>2</sup>)

$$C = 1.66 \text{ (3.0)}$$

$D$  = depth of water ponding above the top of the grate, m (ft)

The inlet capacity of an undepressed curb inlet may be expressed by the equation:

$$Q/l = C \times 10^{-3} d \text{ (g/d)}^{1/2}$$

where  $Q$  = discharge into inlets, m<sup>3</sup>/s (ft<sup>3</sup>/s)

$$C = 1.47 \text{ for m}^3/\text{s} \text{ (4.82 for ft}^3/\text{s)}$$

$l$  = length of opening, m (ft)

$g$  = gravitational acceleration, m<sup>3</sup>/s (ft<sup>3</sup>/s)

$d$  = depth of flow in gutter, m (ft)

or

$$Q/l = C i^{0.579} \left( \frac{Q_o}{\sqrt{(s/n)}} \right)^{0.563}$$

This assumes a gutter of wedge shaped cross-section with a cross-sectional street slope of 10<sup>-3</sup> to 10<sup>-1</sup> with

$Q_o$  = flow in the gutter, m<sup>3</sup>/s (ft<sup>3</sup>/s)

$i$  = transverse slope  $C = (1.87)$

$s$  = hydraulic gradient of gutter

$n$  = coefficient of roughness of gutter

$C = 0.25 \text{ for m}^3/\text{s} \text{ (1.87 for ft}^3/\text{s)}$

The inlet capacity for a slotted drain may be determined from Figure 4.19. The advantages of carryover are shown in Figure 4.18. If carryover is to be permitted, assume a length ( $L_A$ ) such that  $L_A/L_R$  is less than 1.0 but greater than 0.4. It is suggested that  $L$  be in increments of 1.5 m or 3 m (5 or 10 ft) to facilitate fabrication, construction and inspection. Pipe diameter is usually not a factor but it is recommended that a 450 mm (18 in.) minimum be used. It should be carefully noted that, generally, the economics favor slotted drain pipe inlets designed with carryover rather than for total flow interception. Make certain that there is a feasible location to which the carryover may be directed.

Determine the amount of carryover (C.O.) from Figure 4.18.

At on-grade inlets where carryover is not to be permitted,  $L_A$  must be at least the length of  $L_R$ .

Example: if 20% carryover ( $Q_a / Q_d = 80\%$ ) is allowed, then only 58% ( $L_A/L_R$ ) of the total slotted drain length is required, resulting in a 42% savings in material and installation costs.

At sag inlets, the required length of slotted drain,  $L_R$ , for total interception can be calculated from the following equation:

$$L_R = \frac{0.072 Q_D}{\sqrt{h}} \quad (1.401 \text{ for Imperial Units})$$

For sag inlets,  $L_A$  should be at least 2.0 times the calculated  $L_R$  to ensure against the debris hazard.  $L_A$  should never be less than 6 m (20 ft) for sag inlet cases.

The slot should be parallel to the curb and located in the gutter approximately as shown.



Compacting backfill is required for proper installation of all sewers.

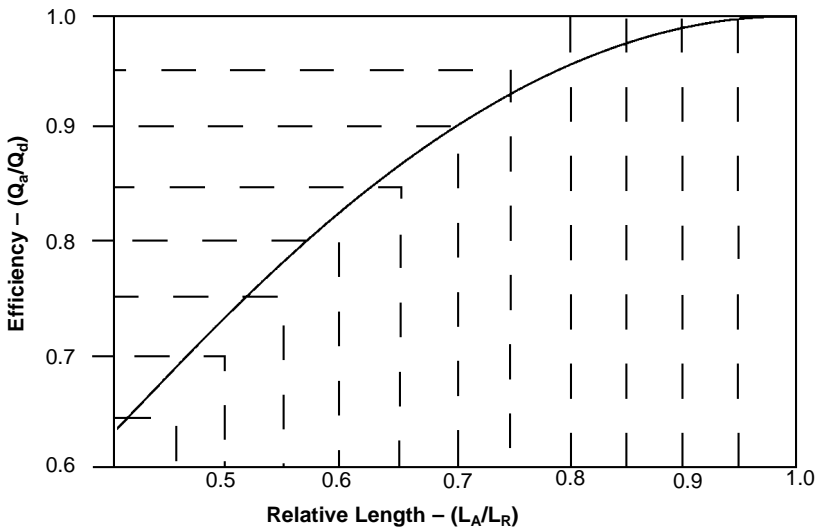
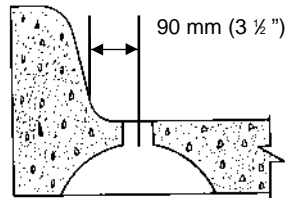
Definitions

- S — Longitudinal gutter or channel slope, m/m (ft/ft)
- S<sub>x</sub> — Transverse slope, m/m (ft/ft)
- Z — Transverse slope reciprocal, m/m (ft/ft)
- d — Depth of flow, m (ft)
- L — Length of slot, m (ft)
- Q — Discharge, m<sup>3</sup>/s (ft<sup>3</sup>/s)
- L<sub>R</sub> — Length of slot required for total interception, m (ft) (no carryover)
- L<sub>A</sub> — An assumed length of slot, m (ft)
- Q<sub>d</sub> — Total discharge at an inlet, m<sup>3</sup>/s (ft<sup>3</sup>/s)
- Q<sub>a</sub> — An assumed discharge, m<sup>3</sup>/s (ft<sup>3</sup>/s)

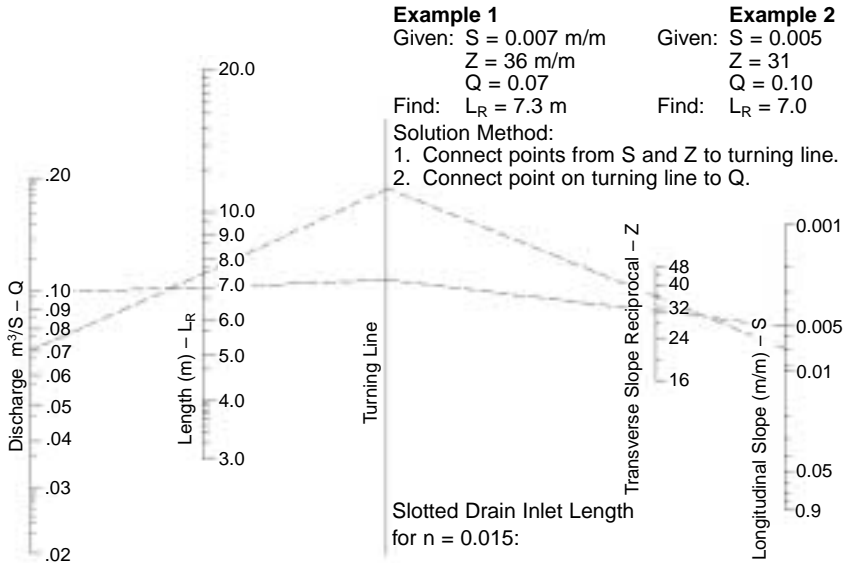
Slotted Drain is used effectively to intercept runoff from wide, flat areas such as parking lots, highway medians — even tennis courts and airport loading ramps. In these installations, the drain is placed transverse to the direction of flow, so that the open slot acts as a weir intercepting all of the flow uniformly along the entire length of the drain. The water is not collected and channeled against a berm, as required by a slot-on-grade installation.

Slotted Drain has been tested for overland flow (sheet flow). These results are published.<sup>18</sup>

The tests included flows up to 0.0037 m<sup>3</sup>/s per meter of slot (0.04 ft<sup>3</sup>/s per foot). The test system was designed to supply at least 0.0023 m<sup>3</sup>/s per meter (0.025 ft<sup>3</sup>/s per foot), which corresponds to a rainstorm of 380 mm/hr (15 in./hr) over a 22 m (72 ft) wide roadway (6 lanes). Slopes ranged from a longitudinal slope of 9 % and a Z of 16, to a longitudinal slope of 0.5% and a Z of 48. At the design discharge of 0.0023 m<sup>3</sup>/s per meter (0.025 ft<sup>3</sup>/s per foot), it was reported that the total flow fell through the slot as a weir flow without hitting the curb side of the slot. Even at the maximum discharge of 0.0037 m<sup>3</sup>/s per meter (0.04 ft<sup>3</sup>/s per foot) and maximum slopes, nearly all the flow passed through the slot.





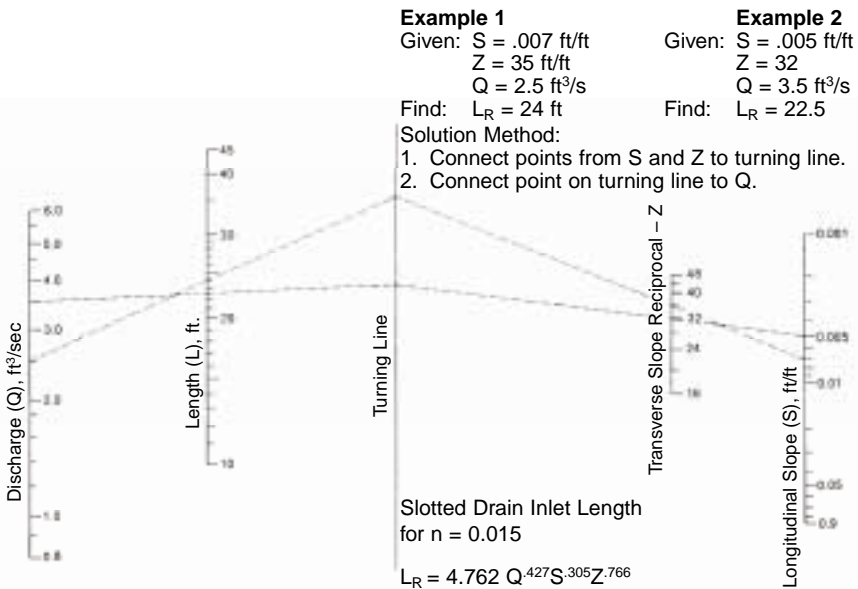


Slotted Drain Inlet Length  
for  $n = 0.015$ :

$$L_R = (6.655) Q^{.427} S^{.305} Z^{.766}$$

$$\text{If } n \neq 0.015, L_r = L_R \left( \frac{0.015}{n} \right)^{0.87}$$

(Extrapolation not recommended)



Slotted Drain Inlet Length  
for  $n = 0.015$

$$L_R = 4.762 Q^{.427} S^{.305} Z^{.766}$$

$$\text{If } n \neq .015, L_r = L_R \left( \frac{.015}{n} \right)^{0.87}$$

(Extrapolation not recommended)

Figure 4.19 Slotted drain design Nomograph.

## REFERENCES

1. Davis, C. B., Sorenson, K. E., *Handbook of Applied Hydraulics*, 3rd Edition, 1969.
2. FHWA, "Hydraulic Design of Highway Culverts," Hydraulic Design Series No. 5, Report No. FHWA-IP-85-15, Sept. 1985, Federal Highway Administration.
3. *Design and Construction of Sanitary and Storm Sewers*, Water and Pollution Control Federation Manual of Practice No. 9 and American Society of Civil Engineers Manuals and Reports on Engineering Practice No. 37, 1969.
4. Silberman, E., Dahlin, W.Q., "Further Studies of Friction Factors for Corrugated Aluminum Pipes Flowing Full," Project Report No. 121, April 1971, University of Minnesota, St. Anthony Falls Hydraulic Laboratory, Minneapolis, MN.
5. Grace, J. L., Jr., "Friction Factors for Hydraulic Design of Corrugated Metal Pipe," Dept. of Defense, U.S. Corps of Engineers, *Proceedings of the Highway Research Board*, U.S. Waterways Experimental Station, Vol. 44, 1965.
6. Webster, M. J. and Metcalf, L. R., "Friction Factors in Corrugated Metal Pipe," *Journal of the Hydraulic Division*, American Society of Civil Engineers, Vol. 85, Sept. 1959, pp. 35-67.
7. Brater, E. F., King, H.W., *Handbook of Hydraulics*, 6th Edition, McGraw-Hill Book Company, 1976.
8. Chow, V. T., *Open Channel Hydraulics*, McGraw-Hill Book Company, 1959.
9. Marsalek, J., "Head Losses at Selected Sewer Manholes," Environmental Hydraulics Section, Hydraulics Division, National Water Research Institute, Canada Centre for Inland Waters, July 1985.
10. Ackers, P., "An Investigation of Head Losses at Sewer Manholes," *Civil Engineering and Public Works Review*, Vol. 54, No. 637, 1959 pp. 882-884 and 1033-1036.
11. Archer, B., Bettes, F. and Colyer, P. J., "Head Losses and Air Entrainment at Surcharged Manholes," Report No. IT185, Hydraulics Research Station, Wallingford, 1978.
12. Black, R. G., Piggott, T. L., "Head Losses at Two Pipe Stormwater Junction Chambers," *Proceedings Second National Conference on Local Government Engineering*, Brisbane, September 19-22, 1983, pp. 219-223.
13. deGrout, C. F., Boyd, M. J., "Experimental Determination of Head Losses in Stormwater Systems," *Proceedings Second National Conference on Local Government Engineering*, Brisbane, September 19-22, 1983.
14. Hare, C. M., "Magnitude of Hydraulic Losses at Junctions in Piped Drainage Systems," *Civil Engineering Transactions*, Institution of Civil Engineers, 1983, pp. 71-77.
15. Howarth, D. A. and Saul, A. J., "Energy Loss Coefficients at Manholes," *Proceedings 3rd International Conference on Urban Storm Drainage*, Goteburg, June 4-8, 1984, pp. 127-136.
16. Wright, K. K., *Urban Storm Drainage Criteria Manual*, Volume I, Wright-McLaughlin Engineers, Denver, Colorado, 1969.
17. Marsalek, J., "Road and Bridge Deck Drainage Systems," Ministry of Transportation and Communications, Research and Development Branch, Ontario, Canada, Nov. 1982.
18. FHWA, Vol. 4, "Hydraulic Characteristics of Slotted Drain Inlets," Feb. 1980, Report No. FHWA-RD-79-106, Federal Highway Administration.
19. Sangster, W.M., Wood, H.W., Smavelor, E.T., Bussy, H.G., "Pressure Changes at Storm Drain Junctions," Engineering Series Bulletin No. VI, Engineering Experiment Station, *The University of Missouri Bulletin*.

---

**BIBLIOGRAPHY**

*Handbook of Steel Drainage and Highway Construction Products*, American Iron and Steel Institute, 1983.

"73-3 Implementation Package for Slotted CMP Surface Drains," U.S. Dept. of Transportation, July 1973.

Jones, C. W., "Design of Culverts."

Bauer, W. J., "Determination of Manning's n for 14 ft. Corrugated Steel Pipe," April 1969, Bauer Engineering, Inc., Chicago, IL, 27 pp. "Debris Control Structures," Hydraulic Engineering Circular No. 9, Feb. 1964, Federal Highway Administration, U.S. Government Printing Office, Washington, D.C. 20402, 37 pp.

"Design Charts for Open Channel Flow," Hydraulic Design Series No. 3, 1961, U.S. Bureau of Public Roads.

Harrison, L. S., Morris, J. C., Normann, J. M., and Johnson, F. L., "Hydraulic Design of Improved Inlets for Culverts," Hydraulic Engineering Circular No. 13, Aug. 1972, Federal Highway Administration, Hydraulics Branch, HNG-31, Washington, D.C. 20590.

Silberman, E., "Effects of Helix Angle on Flow in Corrugated Pipes," *Journal of the Hydraulics Division*, American Society of Civil Engineers, Vol. 96, Nov. 1970, pp. 2253-2263.

Normann, J. M., "Hydraulic Design of Large Structural Plate Corrugated Metal Culverts," Unpublished Report, Jan. 1974, Hydraulics Branch, Bridge Division, Office of Engineering, Federal Highway Administration, Washington, D.C. 20590, 17 pp.



Fabricated fittings are hydraulically superior.

# Hydraulic Design Of Storm Sewers

## CHAPTER 5

---

### INTRODUCTION

The hydraulic design of a sewer system may have to take into account the effect of backwater (the limiting effect on flows that a downstream sewer has on upstream sewers), surcharging, inlet capacity and all energy losses in the system. Whether each, or all, of these factors have to be considered depends on the complexity of the sewer system and the objectives of the analysis (i.e., is the sizing of the system preliminary or final?). Furthermore, the degree of analysis will also depend on the potential impact should the sewer system capacity be exceeded. For example, would surcharging result in damages to private property due to the foundation drains being connected to the system or is the depth of flooding on a roadway important because emergency vehicles depend on safe access along the street. By defining the above factors, the user may then select the level of analysis that is required.

This section will outline two methods using hand calculations. Both methods assume that all flows enter the sewer system, i.e., that the inlet capacity of the system is not a limiting factor. In addition, a listing of various computer models that may be used in the analysis or design of sewer systems is provided.

Flow charts and nomographs such as those presented in Chapter 4 provide quick answers for the friction head losses in a given run of straight conduit between structures (manholes, junctions). These design aids do not consider the additional head losses associated with other structures and appurtenances common in sewer systems.

In most instances, when designing with common friction flow formulae such as the Manning equation, the hydraulic grade is assumed to be equal to the pipe slope at an elevation equal to the crown of the pipe. Consideration must therefore also be given to the changes in hydraulic grade line due to pressure changes, elevation changes, manholes and junctions. The design should then not only be based on the pipe slope, but on the hydraulic grade line.

A comprehensive storm sewer design must therefore proceed on the basis of one run of conduit or channel at a time, working methodically through the system. Only in this way can the free flow conditions be known and the hydraulic grade controlled, thus assuring performance of the system.

Making such an analysis requires backwater calculations for each run of conduit. This is a detailed process, which is demonstrated on the following pages. However, it is recognized that a reasonable conservative “estimate” or “shortcut” will sometimes be required. This can be done and is also demonstrated on pages 160 through 166.

When using the backwater curve approach, the designer should first establish the type of flow (sub-critical or supercritical) to determine the direction his calculations are to proceed.

- Super critical flow – designer works downstream with flow.
- Sub-critical flow – designer works against the flow.
- Hydraulic jump may form if there is super and sub-critical flow in the same sewer.

## BACKWATER ANALYSIS

Given is a flow profile of a storm drainage system (see Figures 5.1 and 5.2) where the hydraulic grade is set at the crown of the outlet pipe. Hydrological computations have been made, and preliminary design for the initial pipe sizing has been completed.

To demonstrate the significance of form losses in sewer design, a backwater calculation will be performed in this example with helical corrugated steel pipe.

### Solution

1. Draw a plan and surface profile of trunk storm sewer.
2. Design discharges,  $Q$ , are known; Areas,  $A$ , are known; Diameters of pipe,  $D$ , have been calculated in preliminary design.
3. Calculate the first section of sewer line. Note: Normal depth is greater than critical depth,  $y_n > y_c$ ; therefore, calculations to begin at outfall working upstream. At "point of control" set design conditions on profile and calculations sheet:

Station 0 + 00 (outfall)

Design discharge	$Q = 7.0 \text{ m}^3/\text{s} \text{ (145 ft}^3/\text{s)}$	(9)
Invert of pipe	$= 28.2 \text{ m (94.50 ft)}$	(2)
Diameter	$D = 1800 \text{ mm (66 in.)}$	(3)
Hydraulic grade elevation	$\text{H.G.} = 30 \text{ m (100 ft)}$	(4)
Area of pipe	$A = 2.54 \text{ m}^2 \text{ (23.76 ft}^2\text{)}$	(6)
Velocity $= \frac{Q}{A}$ ,	$V = 2.8 \text{ m/s (6.1 ft/s)}$	(8)

Note: (1) Numbers in parentheses refer to the columns on Table 5.2.

Compute:

- a. 'K' value (7):  $K = (2g) n^2$  (Derived from Manning-Chezy Formula)
- b. 'Sf' value (12):  $S_f = K \frac{V^2}{2g} \div R^{4/3}$

The friction slope ( $S_f$ ) may also be estimated from Table 5.1 for a given diameter of pipe and with a known 'n' value for the expected flow  $Q$ .

$S_f$  (12) is a "point slope" at each station set forth by the designer. Therefore, the friction slope (Avg.  $S_f$ ) (13) for each reach of pipe  $L$  (14), is the average of the two point slopes  $S_f$  being considered.

- c. Velocity Head (10):  $H_v = \frac{V^2}{2g}$
- d. Energy grade point, E. G. (11) is equal to H. G. (4) plus the velocity head (10).
- e. Friction loss (15): Multiply Avg.  $S_f$  (13) by length of sewer section,  $L$  (14) =  $H_f$  (15).
- f. Calculate energy losses:  $H_b$ ,  $H_j$ ,  $H_m$ ,  $H_t$ , using formulas in text.
- g. Compute new H. G. (4) by adding all energy loss columns, (15) thru (19) to previous H. G.

**Table 5.1M Energy-loss Solution by Manning's Formula For Pipe Flowing Full**

Diameter	Area	Hydraulic Radius	$\left(\frac{n}{AR^{2/3}}\right)^2 \times 10^{-2}$						
	A	R	$R^{2/3}$	$AR^{2/3}$	n = 0.012	n = 0.015	n = 0.019	n = 0.021	n = 0.024
(mm)	(m <sup>2</sup> )	(m)							
200	0.03	0.050	0.136	0.004	792	1238	1986	2426	3168
250	0.05	0.063	0.157	0.008	241	376	604	738	964
300	0.07	0.075	0.178	0.013	91.1	142	228	279	364
375	0.11	0.094	0.206	0.023	27.7	43.3	69.5	84.9	111
450	0.16	0.113	0.233	0.037	10.48	16.38	26.28	32.10	41.93
525	0.22	0.131	0.258	0.056	4.607	7.198	11.55	14.11	18.43
600	0.28	0.150	0.282	0.080	2.260	3.531	5.666	6.921	9.040
675	0.36	0.169	0.305	0.109	1.206	1.884	3.023	3.693	4.824
750	0.44	0.188	0.328	0.145	0.687	1.074	1.724	2.105	2.750
825	0.53	0.206	0.349	0.187	0.414	0.646	1.037	1.266	1.654
900	0.64	0.225	0.370	0.235	0.260	0.406	0.652	0.796	1.040
1050	0.87	0.263	0.410	0.355	0.114	0.179	0.286	0.350	0.457
1200	1.13	0.300	0.448	0.507	0.056	0.088	0.141	0.172	0.224
1350	1.43	0.338	0.485	0.694	0.030	0.047	0.075	0.092	0.120
1500	1.77	0.375	0.520	0.919	0.017	0.027	0.043	0.052	0.068
1650	2.14	0.413	0.554	1.185	0.010	0.016	0.026	0.031	0.041
1800	2.54	0.450	0.587	1.494	0.006	0.010	0.016	0.020	0.026
1950	2.99	0.488	0.619	1.850	0.004	0.007	0.011	0.013	0.017
2100	3.46	0.525	0.651	2.254	0.003	0.004	0.007	0.009	0.011
2250	3.98	0.563	0.681	2.709	0.002	0.003	0.005	0.006	0.008
2400	4.52	0.600	0.711	3.218	0.0014	0.0022	0.0035	0.0043	0.0056
2700	5.73	0.675	0.769	4.406	0.0007	0.0012	0.0019	0.0023	0.0030
2850	6.38	0.713	0.798	5.089	0.0006	0.0009	0.0014	0.0017	0.0022
3000	7.07	0.750	0.825	5.835	0.0004	0.0007	0.0011	0.0013	0.0017
3150	7.79	0.788	0.853	6.646	0.0003	0.0005	0.0008	0.0010	0.0013
3300	8.55	0.825	0.880	7.524	0.0003	0.0004	0.0006	0.0008	0.0010
3450	9.35	0.863	0.906	8.470	0.0002	0.0003	0.0005	0.0006	0.0008
3600	10.18	0.900	0.932	9.488	0.0002	0.0002	0.0004	0.0005	0.0006

Manning Flow Equation:  $Q = \left(\frac{AR^{2/3}}{n}\right)^2 \times S^{1/2}$

Energy Loss =  $S = Q^2 \left(\frac{n}{AR^{2/3}}\right)^2$

To find energy loss in pipe friction for a given Q, multiply Q<sup>2</sup> by the figure under the proper value of n.

**Table 5.1 Energy-loss Solution by Manning's Formula For Pipe Flowing Full**

Diameter (in.)	Area (ft <sup>2</sup> )	Hydraulic Radius (ft)	$\left(\frac{n}{1.486AR^{2/3}}\right)^2 \times 10^{-7}$						
	<i>A</i>	<i>R</i>	<i>R</i> <sup>2/3</sup>	<i>AR</i> <sup>2/3</sup>	n = 0.012	n = 0.015	n = 0.019	n = 0.021	n = 0.024
6	.196	.125	.250	.049	271.600	424,420	681,000	831,940	1,086,350
8	.349	.167	.303	.106	58,000	90,703	145,509	177,730	232,164
10	.545	.208	.351	.191	17,879	27,936	44,802	54,707	71,455
12	.785	.250	.397	.312	6,698	10,466	17,797	20,605	26,791
15	1.227	.3125	.461	.566	2,035.6	3,180.8	5,102.5	6,234.4	8,144.6
18	1.767	.375	.520	.919	772.2	1,206.5	1,935.5	2,364.7	3,088.7
21	2.405	.437	.576	1.385	340.00	531.24	852.60	1,041.0	1,359.98
24	3.142	.50	.630	1.979	166.5	260.04	417.31	510.20	666.39
30	4.909	.625	.731	3.588	50.7	79.126	127.01	155.12	202.54
36	7.069	.75	.825	5.832	19.20	29.953	48.071	58.713	76.691
42	9.621	.875	.915	8.803	8.40	13.148	21.096	25.773	33.667
48	12.566	1.00	1.00	12.566	4.130	6.452	10.353	12.647	16.541
54	15.904	1.125	1.082	17.208	2.202	3.440	5.520	6.741	8.817
60	19.635	1.25	1.16	22.777	1.257	1.965	3.337	3.848	5.030
66	23.758	1.375	1.236	29.365	0.756	1.182	1.895	2.316	3.026
72	28.274	1.50	1.310	37.039	0.475	0.743	1.192	1.456	1.902
78	33.183	1.625	1.382	45.859	0.310	0.485	0.777	0.950	1.241
84	38.485	1.75	1.452	55.880	0.209	0.326	0.524	0.640	0.835
90	44.179	1.875	1.521	67.196	0.144	0.226	0.362	0.442	0.578
96	50.266	2.00	1.587	79.772	0.102	0.160	0.257	0.314	0.410
108	63.617	2.25	1.717	109.230	0.055	0.085	0.137	0.167	0.219
114	70.882	2.375	1.780	126.170	0.041	0.064	0.103	0.125	0.164
120	78.54	2.5	1.842	144.671	0.031	0.049	0.078	0.098	0.125

$$\text{Manning Flow Equation: } Q = \left( A \times \frac{1.486}{n} \times R^{2/3} \right) \times S^{1/2}$$

$$\text{Energy Loss} = S = Q^2 \left( \frac{n}{1.486 AR^{2/3}} \right)^2$$

To find energy loss in pipe friction for a given Q, multiply Q<sup>2</sup> by the figure under the proper value of n.



**Table 5.2M Hydraulic Calculation Sheet**

1	2	3	4	5	6	7	8	9	10	11	12	13	14	15	16	17	18	19	20
Station	Invest	D	H.g.	Section	A	K	V	Q	V <sup>2</sup> /2g	E.G.	S <sub>1</sub>	Avg.S <sub>t</sub>	L	H <sub>t</sub>	H <sub>b</sub>	H <sub>j</sub>	H <sub>m</sub>	H <sub>t</sub>	E.G
	(m)	(mm)	(m)		(m <sup>2</sup> )		(m/s)	(m <sup>3</sup> /s)	(m)	(m)	(m/m)	(m/m)	(m)	(m)	(m)	(m)	(m)	(m)	(m)
0+000.000	28.200	1800	30.000	0	2.54	0.01130	2.8	7.0	0.39	30.390	0.0127	0.0127	33.5	0.424	0.056				30.390
0+033.528	28.625	1800	30.424	0	2.54	0.01130	2.8	7.0	0.39	30.814	0.127	0.0127	4.7	0.059					30.814
0+038.222	28.740	1800	30.540	0	2.54	0.01130	2.8	7.0	0.39	30.930	0.0127	0.0127	37.4	0.473					30.930
0+075.590	29.212	1800	31.012	0	2.54	0.01130	2.8	7.0	0.39	31.402	0.0127	0.0266	2.3	0.061				0.132	31.402
0+077.876	29.805	1400	31.205	0	1.54	0.00950	4.5	7.0	1.05	32.255	0.0406	0.0406	30.5	1.238					32.255
0+108.356	31.043	1400	32.443	0	1.54	0.00950	4.5	7.0	1.05	33.493	0.0406	0.0406	30.5	1.238		1.085	0.053		33.493
0+138.836	32.334	1400	33.734	0	1.54	0.00950	4.5	7.0	1.05	34.784	0.0406	0.0299	3.1	0.092					34.784
0+141.900	33.711	1200	34.911	0	1.13	0.00785	3.1	3.5	0.49	35.401	0.0191	0.0191	35.0	0.669		1.299			35.401
0+176.900	34.380	1200	35.580	0	1.13	0.00785	3.1	3.5	0.49	36.70	0.0191	0.0351	3.5	0.123					36.070
0+180.421	36.402	600	37.002	0	0.28	0.00636	3.5	1.0	0.64	37.492	0.0511	0.0511	35.5	1.814			0.032		37.492
0+215.892	38.248	600	38.848	0	0.28	0.00636	3.5	1.0	0.64	39.338	0.0511								39.338

n = Variable

$$K = 2g(n^2)$$

$$Sf = K \left( \frac{v^2}{2g} \right) \div R^{4/3}$$

$$\Sigma H_{friction} = 6.191$$

$$\Sigma H_{form} = 2.657$$

**Table 5.2 Hydraulic Calculation Sheet**

1	2	3	4	5	6	7	8	9	10	11	12	13	14	15	16	17	18	19	20
Station	Invest	D	H.g.	Section	A	K	V	Q	V <sup>2</sup> /2g	E.G.	S <sub>f</sub>	Avg.S <sub>f</sub>	L	H <sub>t</sub>	H <sub>b</sub>	H <sub>j</sub>	H <sub>m</sub>	H <sub>t</sub>	E.G.
	(ft)	(in.)	(ft)		(ft <sup>2</sup> )		(ft/s)	(cfs)	(ft)	(ft)	(ft/ft)	(ft/ft)	(ft)	(ft)	(ft)	(ft)	(ft)	(ft)	(ft)
0+00	94.50	66	100	0	23.76	0.01678	6.1	145	0.58	100.58	0.0064	0.0064	100	0.70					100.58
1+10	95.20	66	100.70	0	23.76	0.01678	6.1	145	0.58	101.28	0.0064	0.0064	42.4	0.27	0.08				101.28
1+52.4	95.55	66	101.05	0	23.76	0.01678	6.1	145	0.58	101.63	0.0064	0.0064	95.6	0.61					101.63
2+48	96.16	66	101.66	0	23.76	0.01678	6.1	145	0.58	102.24	0.0064	0.0110	7.5	0.08				0.14	102.24
2+55.5	96.67	54	101.17	0	15.90	0.01410	9.1	145	1.29	102.46	0.0155	0.0155	100	1.55			0.06		102.46
3+55.5	98.28	54	102.78	0	15.90	0.01410	9.1	145	1.29	104.07	0.0155	0.0155	100	1.55					104.07
4+55.5	99.83	54	104.33	0	15.90	0.01410	9.1	145	1.29	105.62	0.0155	0.0150	10	0.15		0.88			105.62
4+65.5	101.66	48	105.66	0	12.57	0.01166	8.0	100	0.99	106.65	0.0115	0.0115	100	1.15					106.65
5+65.5	102.81	48	106.81	0	12.57	0.01166	8.0	100	0.99	107.80	0.0115	0.0118	10	0.12		3.78			107.80
5+75.5	109.06	24	111.06	0	3.14	0.00746	6.4	20	0.64	111.70	0.0120	0.0120	100	1.20			0.03		111.70
6+75.5	110.29	24	112.29	0	3.14	0.00746	6.4	20	0.64	112.93	0.0120								112.93

n = Variable

$$K = \frac{2g(n^2)}{2.21}$$

$$S_f = K \left( \frac{v^2}{2g} \right) \div R^{4/3}$$

$$\Sigma H_{\text{friction}} = 7.38$$

$$\Sigma H_{\text{form}} = 4.97$$

Note: If sewer system is designed under pressure (surcharging), then energy losses must be added (or subtracted, depending on whether you are working upstream or downstream) to the energy grade line, E. G.

- h. Set new E. G. (20) equal to E. G. (11)
- i. Determine conduit invert (2). In the example we are designing for full flow conditions; therefore, H. G. (4) is at crown of pipe and invert (2) is set by subtracting, D (3) from H. G. (4).
- j. Continue to follow the above procedure taking into account all form head losses.
- k. Complete profile drawing; showing line, grade and pipe sizes. This saves time and usually helps in spotting any design errors.

### Energy Losses

Station 0 + 033.528 to 0 + 038.222 (Bend)

$$H_b = K \left( \frac{V^2}{2g} \right), \text{ where } K_b = 0.25 \sqrt{\frac{\Phi}{90}}$$

$\Phi$ , central angle of bend =  $30^\circ$

$$K_b = 0.25 \sqrt{\frac{30}{90}} = 0.1443$$

$$\therefore H_b = 0.1433 (0.39) = 0.056 \text{ m (0.08 ft)}$$

Station 0 + 075.590 to 0 + 077.876 (Transition)

$$H_t = 0.2 \left( \frac{V_1^2}{2g} - \frac{V_2^2}{2g} \right)$$

$$= 0.2 (1.05 - 0.39)$$

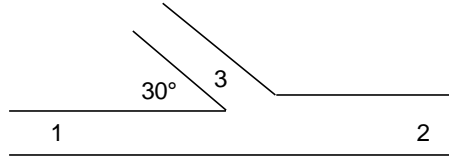
$$= 0.132 \text{ m (0.14 ft)}$$

Station 0 + 108.356 (Manhole)

$$H_m = 0.05 \left( \frac{V^2}{2g} \right)$$

$$= 0.05 (1.05) = 0.053 \text{ m (0.06 ft)}$$

Station 0 + 138.836 to 0 + 141.900 (Junction)



$$Q_1 = 3.5 \text{ m}^3/\text{s} \text{ (100 ft}^3/\text{s)} \quad Q_2 = 7.0 \text{ m}^3/\text{s} \text{ (145 ft}^3/\text{s)} \quad Q_3 = 3.5 \text{ m}^3/\text{s} \text{ (45 ft}^3/\text{s)}$$

$$A_1 = 1.13 \text{ m}^2 \text{ (12.57 ft}^2) \quad A_2 = 1.54 \text{ m}^2 \text{ (15.9 ft}^2) \quad A_3 = 1.13 \text{ m}^2 \text{ (5.0 ft}^2)$$

$$D_1 = 1200 \text{ mm (48 in.)} \quad D_2 = 1400 \text{ mm (4.5 ft)} \quad D_3 = 1200 \text{ mm (2.5 ft)}$$

$$\theta_3 = 30$$

$\Sigma P = \Sigma M$  (Pressure plus momentum laws)

$$(H_j + D_1 - D_2) \left( \frac{A_1 + A_2}{2} \right) = \frac{Q_2^2}{A_2 g} - \frac{Q_1^2}{A_1 g} - \frac{Q_3^2 \cos \Phi}{A_3 g}$$

$$(H_j + 1.2 - 1.40) \left( \frac{1.13 + 1.54}{2} \right) = \frac{(7.0)^2}{(1.54)(9.81)} - \left( \frac{3.52^2}{1.13(9.81)} \right) - \left( \frac{3.52^2 \cos 30^\circ}{1.13(9.81)} \right)$$

$$1.335 H_j - 0.2(1.335) = 3.243 - 1.105 - 0.957$$

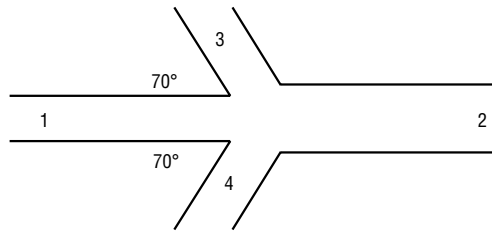
$$1.335 H_j - 0.267 = 1.181$$

$$H_j = 1.085 \text{ m (0.88 ft)}$$



Fittings and elbows are easily fabricated in all sizes.

Station 0 + 176.900 to 0 + 180.421 (Junction)



$Q_1 = 1.0 \text{ m}^3/\text{s}$ (20 ft <sup>3</sup> /s)	$Q_2 = 3.5$ (100)	$Q_3 = 1.5$ (60)	$Q_4 = 1.0$ (20)
$A_1 = 0.28 \text{ m}^2$ (3.14 ft <sup>2</sup> )	$A_2 = 1.13$ (12.57)	$A_3 = 0.64$ (7.07)	$A_4 = 0.28$ (3.14)
$D_1 = 600 \text{ mm}$ (24 in.)	$D_2 = 1200 \text{ mm}$ (48 in.)	$D_3 = 900$ (36)	$D_4 = 600$ (24)
		$\theta_3 = 70^\circ$	$\theta_4 = 70^\circ$

$$(H_j + D_1 - D_2) \left( \frac{A_1 + A_2}{2} \right) = \frac{Q_2^2}{A_2 g} - \frac{Q_1^2}{A_1 g} - \frac{Q_3^2 \cos \theta_3}{A_3 g} - \frac{Q_4^2 \cos \theta_4}{A_4 g}$$

$$(H_j + 0.6 - 1.2) \frac{0.28 + 1.13}{2} = \frac{(3.5)^2}{(1.13)(9.81)} - \frac{(1.0)^2}{(0.28)(9.81)} - \frac{(1.5)^2 \cos 70^\circ}{(0.64)(9.81)} - \frac{(1.0)^2 \cos 70^\circ}{(0.28)(9.81)}$$

$$0.705 H_j - 0.6 (0.705) = 1.105 - 0.364 - 0.123 - 0.125$$

$$0.705 H_j - 0.423 = 0.493$$

$$H_j = 1.299 \text{ m (3.78 ft)}$$

Station 0 + 215.892 (Manhole)

$$H_m = .05 \left( \frac{V^2}{2g} \right) = .05 (0.64)$$

$$= 0.032 \text{ m (0.03 ft)}$$

Total friction  $H_f$  throughout the system = 6.191 m (7.38 ft)

Total form losses = 2.657 m (3.97 ft)

In this example, the head losses at junctions and transition could also have been accommodated by either increasing the pipe diameter or increasing the slope of the pipe.

This backwater example was designed under full flow conditions but could also have been designed under pressure; allowing surcharging in the manholes, which would have reduced the pipe sizes. Storm sewer systems, in many cases, can be designed under pressure to surcharge to a tolerable hydraulic gradeline level.

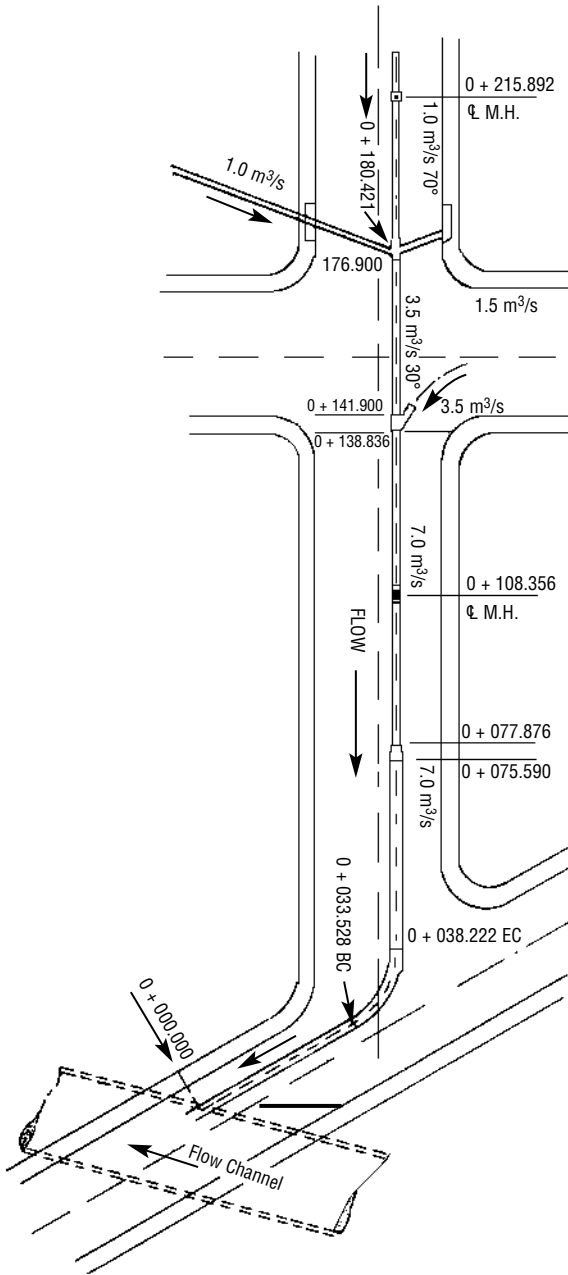


Figure 5.1 Plan for storm sewer.

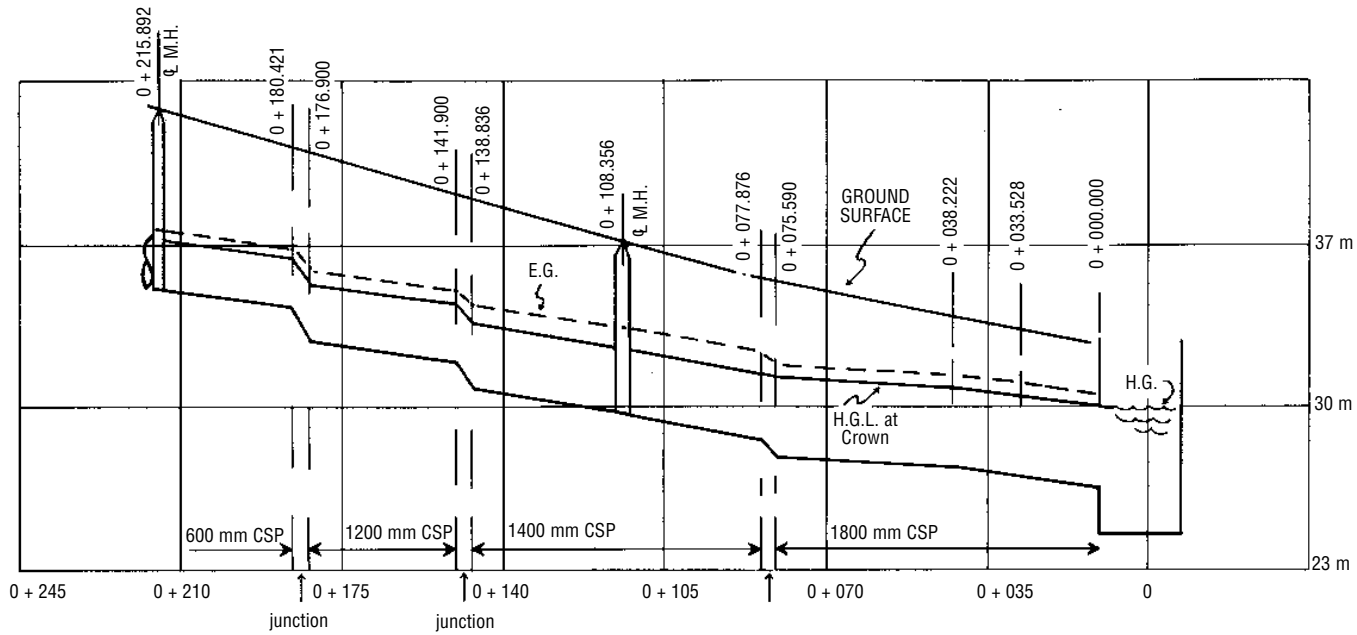


Figure 5.2 Profile for storm sewer.

## METHODS OF DETERMINING EQUIVALENT HYDRAULIC ALTERNATIVES

A method has been developed to aid the designer in quickly determining equivalent pipe sizes for alternative material, rather than computing the backwater profiles for each material.

The derivation shown below allows the designer to assign representative values for loss coefficients in the junctions and length of average reach between the junctions, and develop a relationship for pipes of different roughness coefficients. In this manner the designer need only perform a detailed hydraulic analysis for one material, and then relatively quickly determine conduit sizes required for alternative materials. The relationships for hydraulic equivalent alternatives in storm sewer design may be derived from the friction loss equation.

The total head loss in a sewer system is composed of junction losses and friction losses:

$$H_T = H_j + H_f$$

$$\text{where: } H_j = K_j \frac{V^2}{2g}$$

$$= K_j \frac{Q^2}{A^2 2g}$$

$$= K_j \frac{Q^2 16}{\pi^2 D^4 2g}$$

where:

$$H_f = \frac{2n^2 LV^2}{R^{4/3} 2g} = \frac{13 n^2 L Q^2 (16)}{2g \pi^2 D^{16/3}} \text{ for } K_f = 2n^2$$

$$H_T = H_j + H_f$$

$$= \frac{16 Q^2 K_j}{2g \pi^2 D^{16/3}} + \frac{13 n^2 L Q^2 (16)}{2g \pi^2 D^4}$$

$$= \frac{8Q^2}{g\pi^2} \left[ \frac{K_j D^{4/3} + 13 n^2 L}{D^{16/3}} \right]$$



Philadelphia Airport, fiber-bonded, full bituminous coated and full paved CSP with semi-corrugated bands with O-ring gaskets, provides storm drainage for airport— 5800 m (19,000 ft) of 2100 mm (84 in.) through 2550 mm (102 in.) diameters, 2-3 m (6-10 ft) of cover.



Thus, for comparison of concrete and steel:

$$\frac{8Q^2}{g\pi} = \left[ \frac{K_j(D_c)^{4/3} + 13(n_c)^2L}{(D_c)^{16/3}} \right] = \frac{8Q^2}{g\pi} = \left[ \frac{K_j(D_s)^{4/3} + 13(n_s)^2L}{(D_s)^{16/3}} \right]$$

The flow  $Q$  for each conduit will be the same, therefore the relationship simplifies to:

$$\frac{K_j(D_c)^{4/3} + 13(n_c)^2L}{(D_c)^{16/3}} = \frac{K_j(D_s)^{4/3} + 13(n_s)^2L}{(D_s)^{16/3}}$$

Average values for conduit length between manholes ( $L$ ), and junction loss coefficient ( $K_j$ ), must next be selected. Representative values may be derived for the hydraulic calculations that will have already been performed for one of the materials.

In this example, the average conduit length is 90 m (300 ft) with an average junction loss coefficient of 1.0. With the selected  $L$ ,  $n$  and  $K_j$  values the equations are determined for a series of pipe diameters. The results are shown in Tables 5.3. These figures are then plotted on semi-log paper, from which hydraulically equivalent materials may be easily selected (Figures 5.3 and 5.4).



Combination increaser, manhole and elbow in one length of pipe.

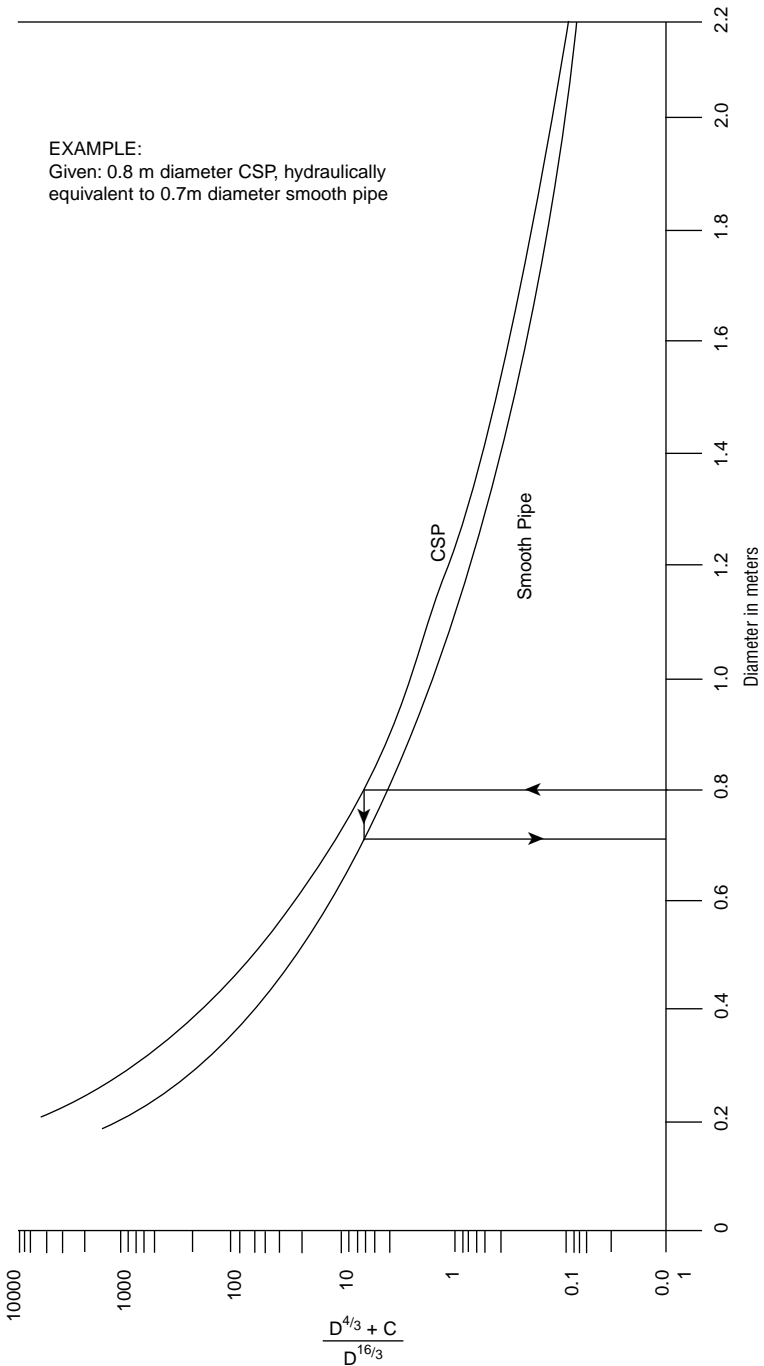


Figure 5.3M Equivalent alternatives with annular CSP where  $C = 13n^2L$ .

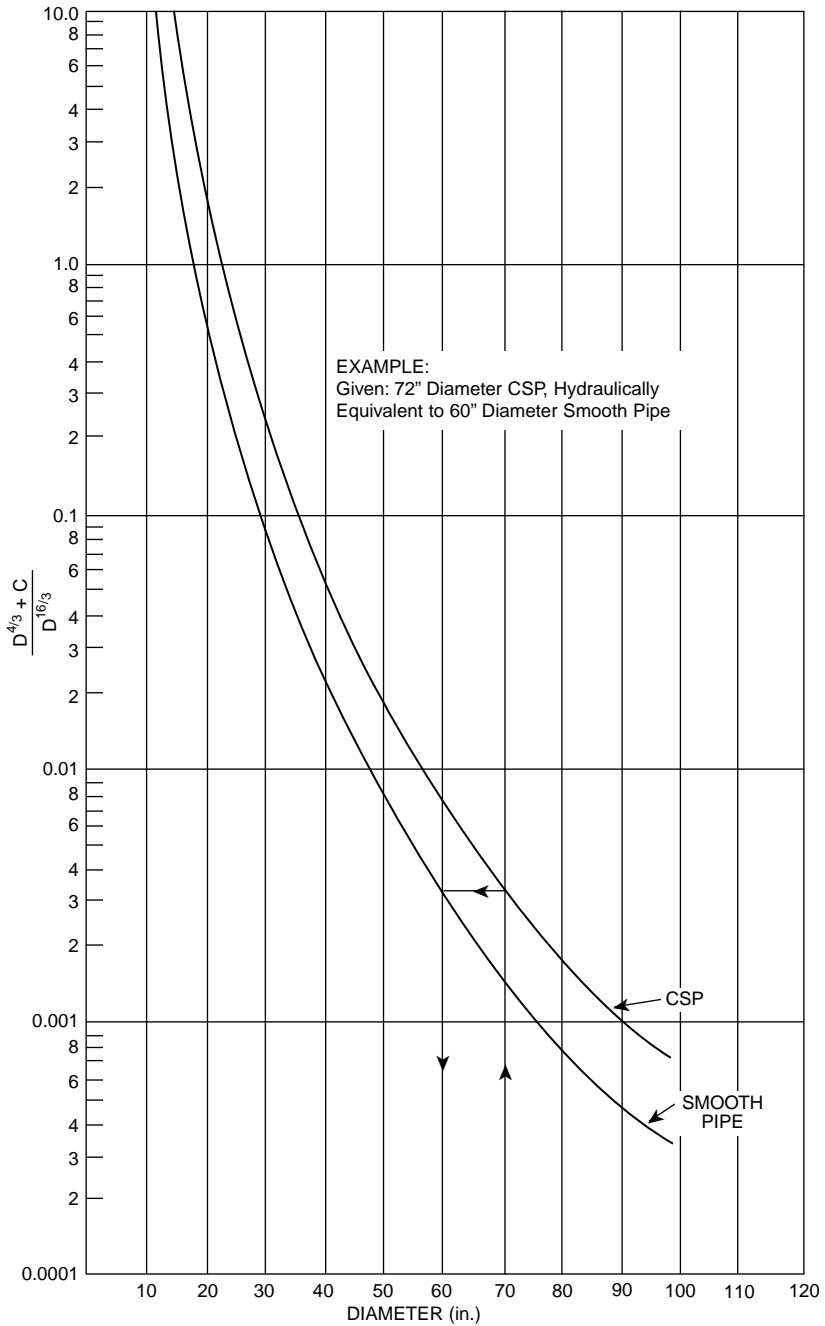


Figure 5.3 Equivalent alternatives with annular CSP 2½ x ½in. where C = 185n<sup>2</sup>L.

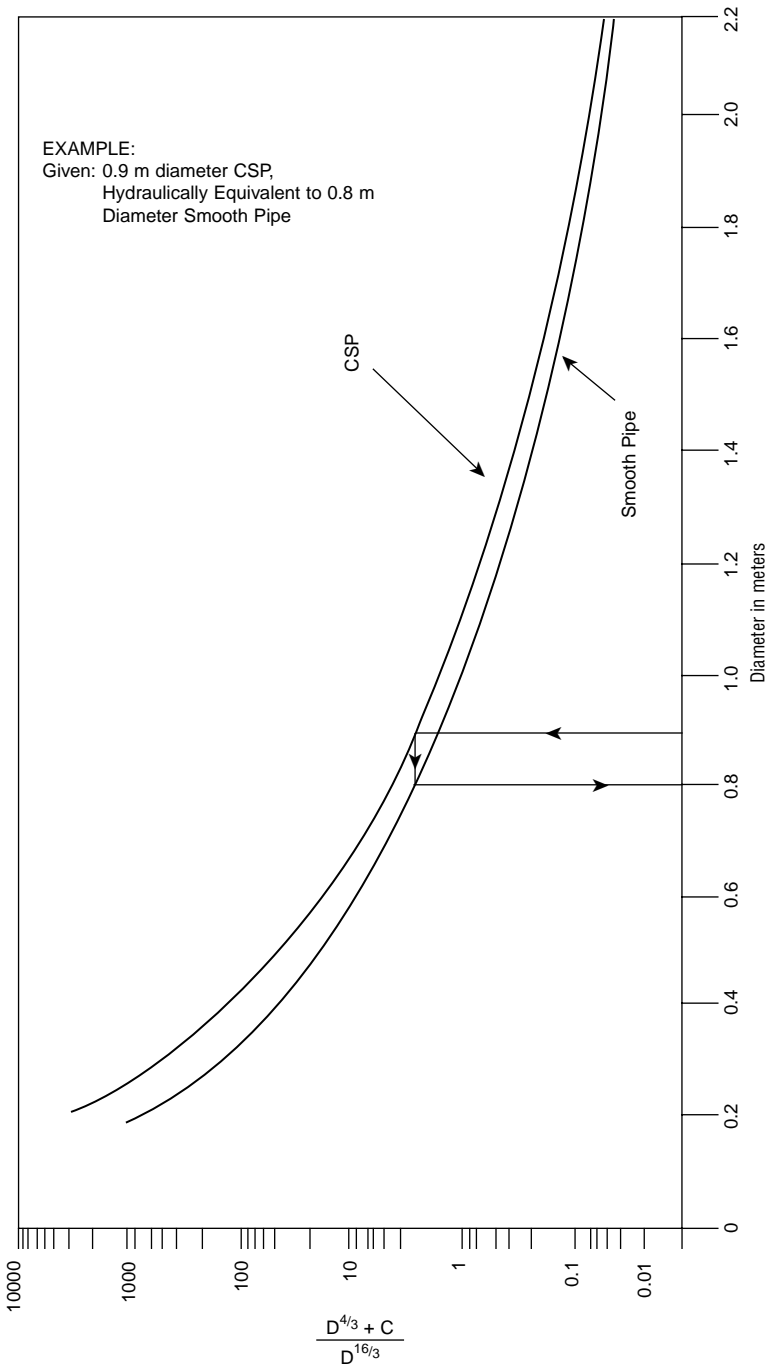


Figure 5.4M Equivalent alternatives with helical CSP (n variable) where C = 13n<sup>2</sup>L.

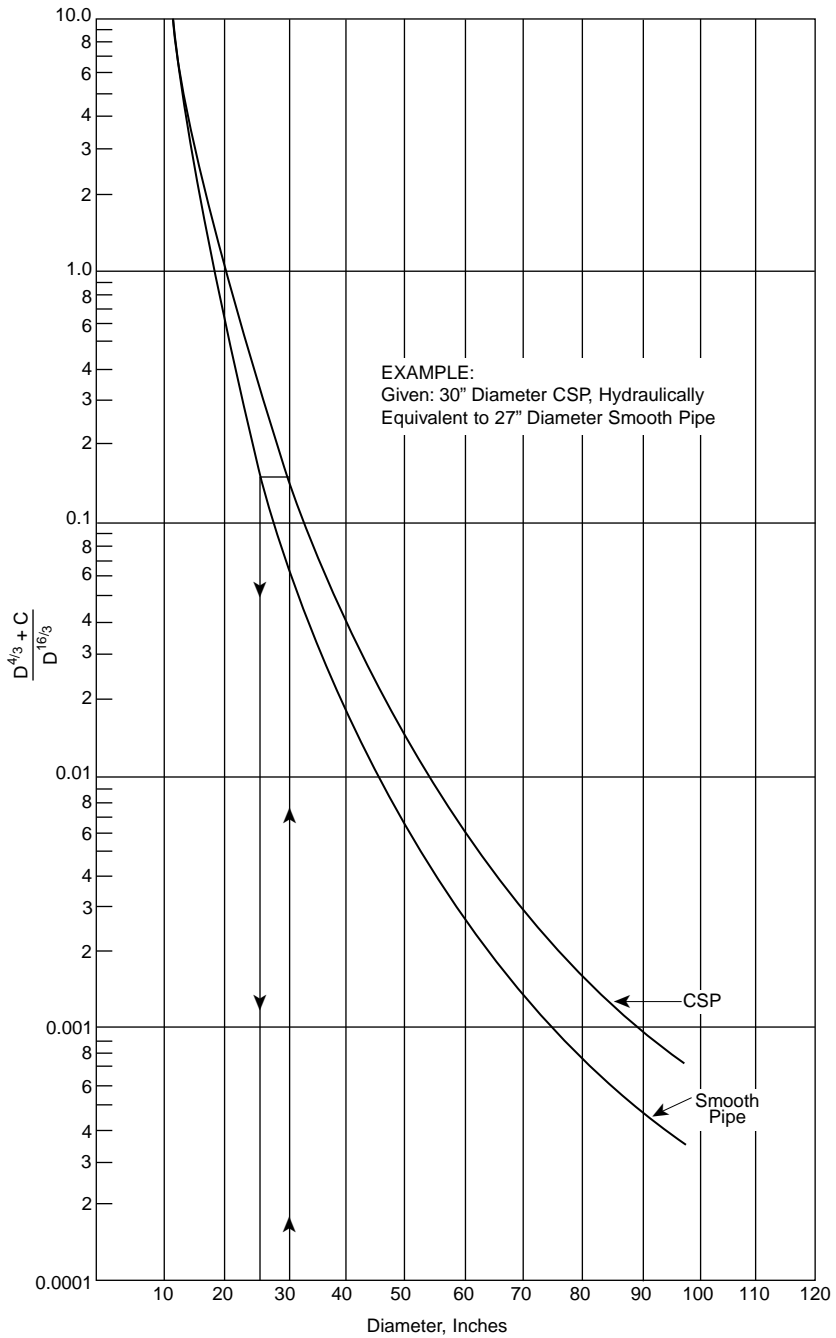


Figure 5.4 Equivalent alternatives with helical CSP 2½ x ½ in. (n variable) where C = 185n<sup>2</sup>L.

**Table 5.3M Methods of Determining Equivalent Alternatives**

Diameter (mm)	Junction and Friction Losses			
	$K_f = 1.0$	Annular CSP Pipe $n = 0.024$	L = 90 m	
	Smooth Pipe $n = 0.012$		Helical CSP Pipe $n$ var. (see Table 4.9)	
	$\frac{D^{4/3} + 0.168}{D^{16/3}}$	$\frac{D^{4/3} + 0.674}{D^{16/3}}$	$\frac{D^{4/3} + 1170 n^2}{D^{16/3}}$	$n$ values
200	1525.30	4226.21	1525.30	0.012
250	529.86	1351.46	628.76	0.014
300	227.03	537.74	210.48	0.011
375	82.07	176.59	82.07	0.012
450	36.30	72.05	38.37	0.013
525	18.40	34.11	20.29	0.014
600	10.28	17.99	11.73	0.015
675	6.19	10.30	7.25	0.016
750	3.94	6.29	4.55	0.016
825	2.63	4.04	3.10	0.017
900	1.82	2.71	2.19	0.018
1050	0.95	1.34	1.15	0.019
1200	0.55	0.74	0.66	0.020
1350	0.34	0.44	0.40	0.020
1500	0.22	0.28	0.26	0.021
1650	0.15	0.18	0.17	0.021
1800	0.10	0.12	0.12	0.021
1950	0.07	0.09	0.08	0.021
2100	0.05	0.06	0.06	0.021
2250	0.04	0.05	0.05	0.021
2400	0.03	0.04	0.03	0.02

**Notes:** Pipe diameter in meters in above equations.

**Table 5.3 Methods of Determining Equivalent Alternatives**

Diameter (in.)	Junction and Friction Losses			
	$K_f = 1.0$	Annular CSP Pipe $n = 0.024$	L = 300ft.	
	Smooth Pipe $n = 0.012$		Helical CSP Pipe $n$ var. (see Table 4.9)	
	$\frac{D^{4/3} + 0.168}{D^{16/3}}$	$\frac{D^{4/3} + 0.674}{D^{16/3}}$	$\frac{D^{4/3} + 1170 n^2}{D^{16/3}}$	$n$ values
12	8.98	32.40	7.72	0.011
15	2.84	10.10	2.84	0.012
18	1.11	3.85	1.28	0.013
21	0.513	1.73	0.657	0.014
24	0.263	0.860	0.372	0.015
30	0.086	0.268	0.147	0.017
36	0.0352	0.103	0.064	0.018
42	0.0168	0.0471	0.0318	0.019
48	0.0087	0.0233	0.0176	0.020
54	0.0051	0.0131	0.0105	0.021
60	0.0031	0.0076	0.00618	0.021
66	0.00205	0.0048	0.00385	0.021
72	0.00134	0.00303	0.0025	0.021
78	0.000884	0.00203	0.00169	0.021
84	0.0006648	0.001409	0.00118	0.021
90	0.0004880	0.001003	0.000843	0.021
96	0.0003659	0.0007309	0.000618	0.021

**Notes:** Pipe diameter in meters in above equations.

## DESIGN OF STORM DRAINAGE FACILITIES

### System Layout

The storm drainage system layout should be made in accordance with the urban drainage objectives, following the natural topography as closely as possible. Existing natural drainage paths and watercourses such as streams and creeks should be incorporated into the storm drainage system. Thus the storm design should be undertaken prior to finalization of the street layout to effectively incorporate the major-minor drainage concepts.

Topographic maps, aerial photographs, and drawings of existing services are required before a thorough storm drainage design may be undertaken.

Existing outfalls within the proposed development and adjacent lands for both the minor and major system should be located. Allowances should be made for external lands draining through the proposed development both for present conditions and future developments.

The design flows used in sizing the facilities that will comprise the drainage network are based on a number of assumptions. Flows that will occur under actual conditions will thus be different from those estimated at the design stage; “the designer must not be tempted by the inherent limitations of the basic flow data to become sloppy in the hydraulic design.”<sup>1</sup> Also, the designer should not limit his investigation to system performance under the design storm conditions, but should assure that in cases where sewer capacities are exceeded, such incidents will not create excessive damage.

This requirement can only be practically achieved if the designer realizes that a dual drainage system exists, comprised of the minor system and the major system. Utilizing both systems, the pipe system may be provided for smaller, more frequent rainfall events, and an overland system for extreme rainfall events.

In the layout of an effective storm drainage system, the most important factor is to assure that a drainage path both for the minor and major systems be provided to avoid flooding and ponding in undesirable locations.

### Minor System

The minor system consists chiefly of the storm sewer comprised of inlets, conduits, manholes and other appurtenances designed to collect and convey into a satisfactory system outfall, storm runoff for frequently occurring storms (2 to 5-year design).

Storm sewers are usually located in rights-of-way such as roadways and easements for ease of access during repair or maintenance operations.

### Major System

The major drainage system will come into operation when the minor system's capacity is exceeded or when inlet capacities significantly control discharge to the minor system. Thus, in developments where the major system has been planned, the streets will act as open channels draining the excess storm water. The depth of flow on the streets should be kept within reasonable limits for reasons of safety and convenience. Consideration should be given to the area of flooding and its impact on various street classifications and to public and private property. Typical design considerations are given in Table 5.4.

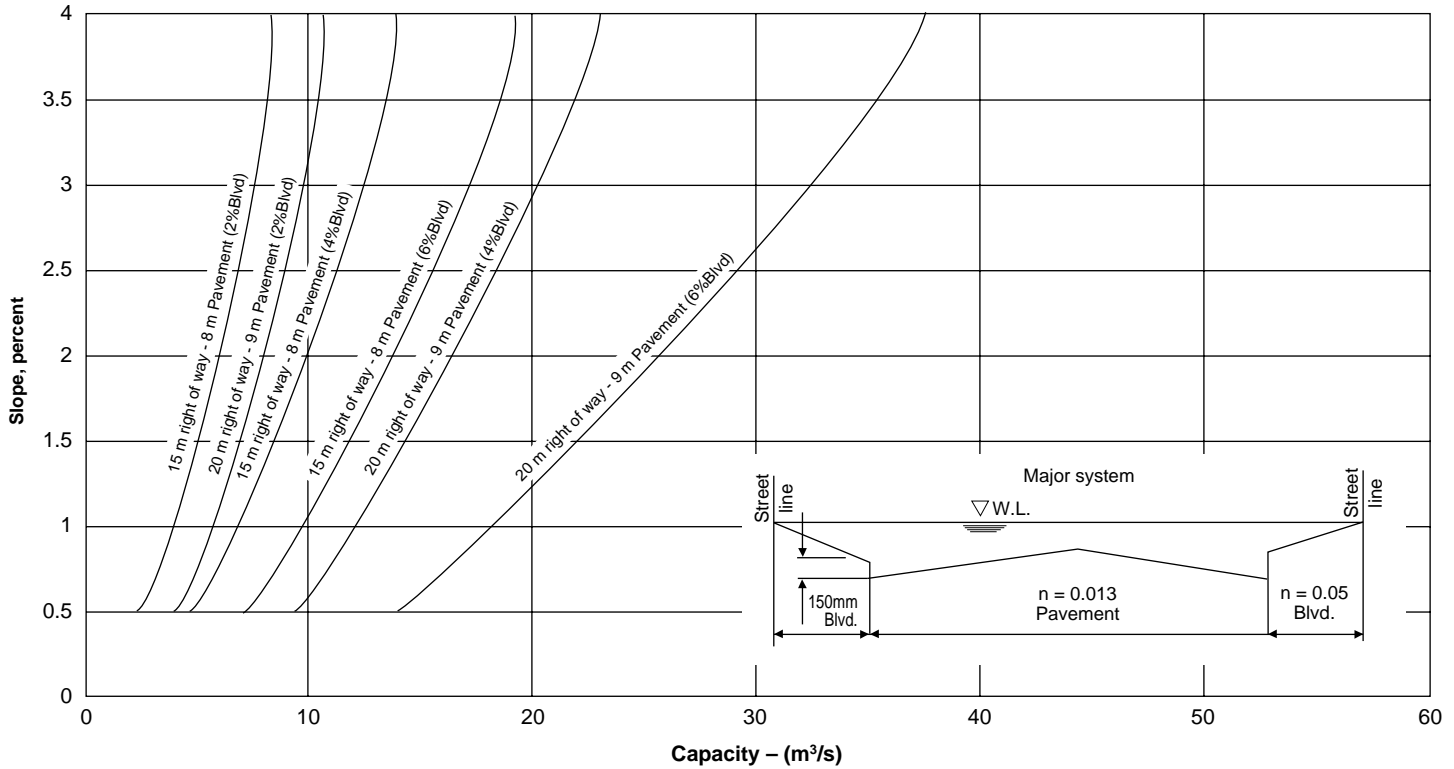


Figure 5.5M Hydraulic capacity of roadways

Note: Blvd. = Boulevard



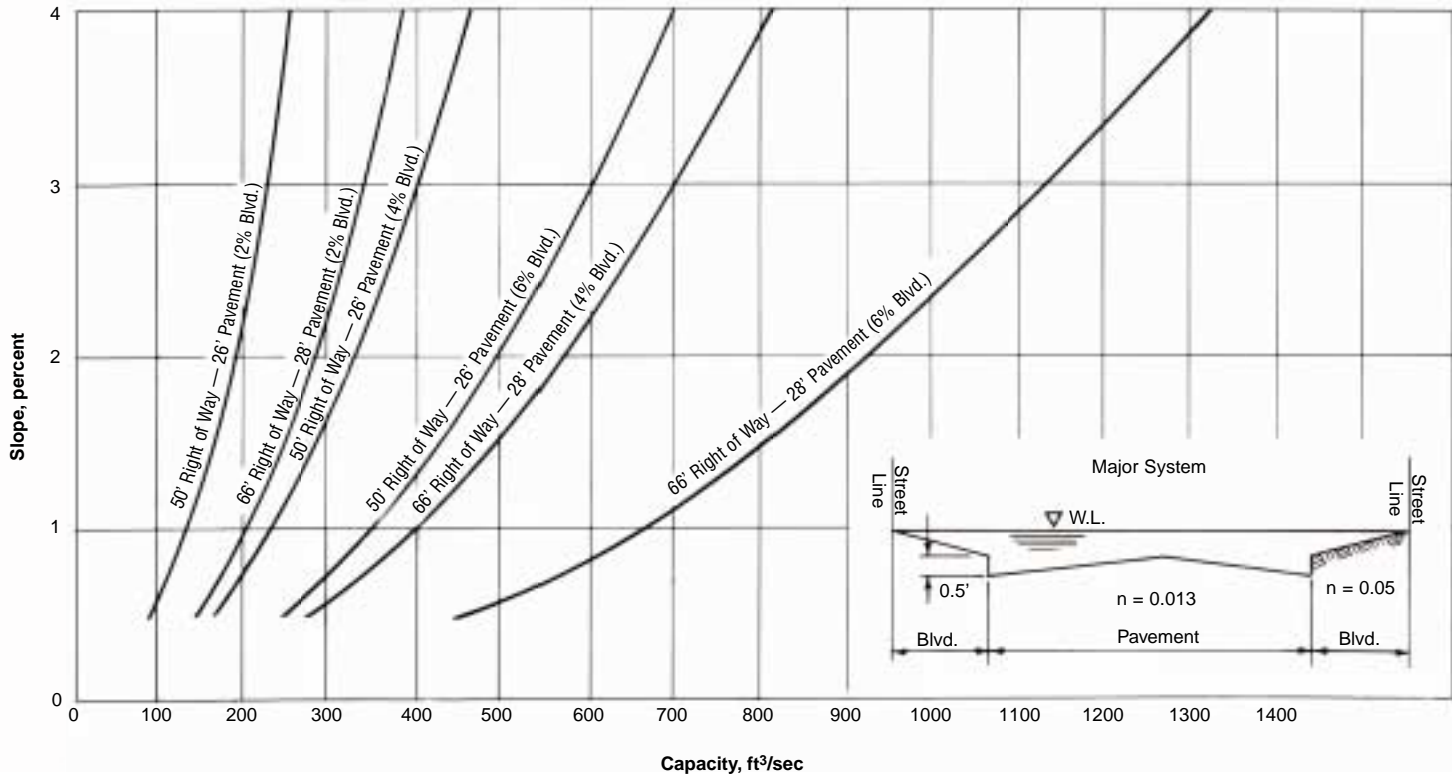


Figure 5.5 Hydraulic capacity of roadways

Note: Blvd. = Boulevard

**Table 5.4 Typical Maximum Flow Depths**

Location*	Storm Return Frequency (Years)		
	5	25	40
Walkways, Open spaces	Minor surface flow up to 25 mm (1 in.) deep on walkways	As required for overland flow outlets	As required for overland flow outlets
Minor, Local and Feeder Roads	1 m (3 ft) wide in gutters or 100 mm (4 in.) deep at low point catch basins	100 mm (4 in.) above crown  up to crown	200 mm (8 in.) above crown  100 mm (4 in.) above crown
Collector and Industrial Roads	Minor surface flow 25 mm (1 in.)	up to crown	100 mm (4 in.) above crown
Arterial Roads	Minor Surface flow 25 mm (1 in.)	1 lane clear	up to crown

**Notes:** \*In addition to the above, residential buildings, public, commercial and industrial buildings should not be inundated at the ground line for the 100 year storm, unless buildings are flood-proofed.

To prevent the flooding of basement garages, driveways will have to meet or exceed the elevations corresponding to the maximum flow depth at the street.

The flow capacity of the streets may be calculated from the Manning equation, or Figure 5.5 may be used to estimate street flows.

When designing the major system, it should be done in consideration of the minor system, with the sum of their capacities being the total system's capacity. The minor system should be first designed to handle a selected high frequency storm, (i.e., 2-year) next the major system is designated for a low frequency of flood storm, (i.e., 100-year). If the roadway cannot handle the excess flow, the minor system should be enlarged accordingly.



Multiple inline storage installation.

## HYDRAULIC DESIGN EXAMPLE OF MINOR-MAJOR SYSTEM

### Description of Site

The site for this design example is shown on Figure 5.6.

The site is about 15 hectares (6 acres) in size consisting of single family and semi-detached housing as well as a site for a public school. The site slopes generally from west to east, where it is bounded by a major open water course. To accommodate the principles of the “minor-major” storm drainage systems, the streets have been planned to conform as much as possible to the natural contours of the lands. Where sags in roadways between intersections could not be avoided, overflow easements or walkways have been provided to permit unobstructed surface runoff during major storms, as shown on Figure 5.7.

### Selected Design Criteria

Based on a reasonable level of convenience to the public, a two-year design curve is considered adequate as a design basis for the minor system within this development.



Storm Sewer installation involved 1300 m (4300 ft) of full bituminous coated full paved pipe arch.

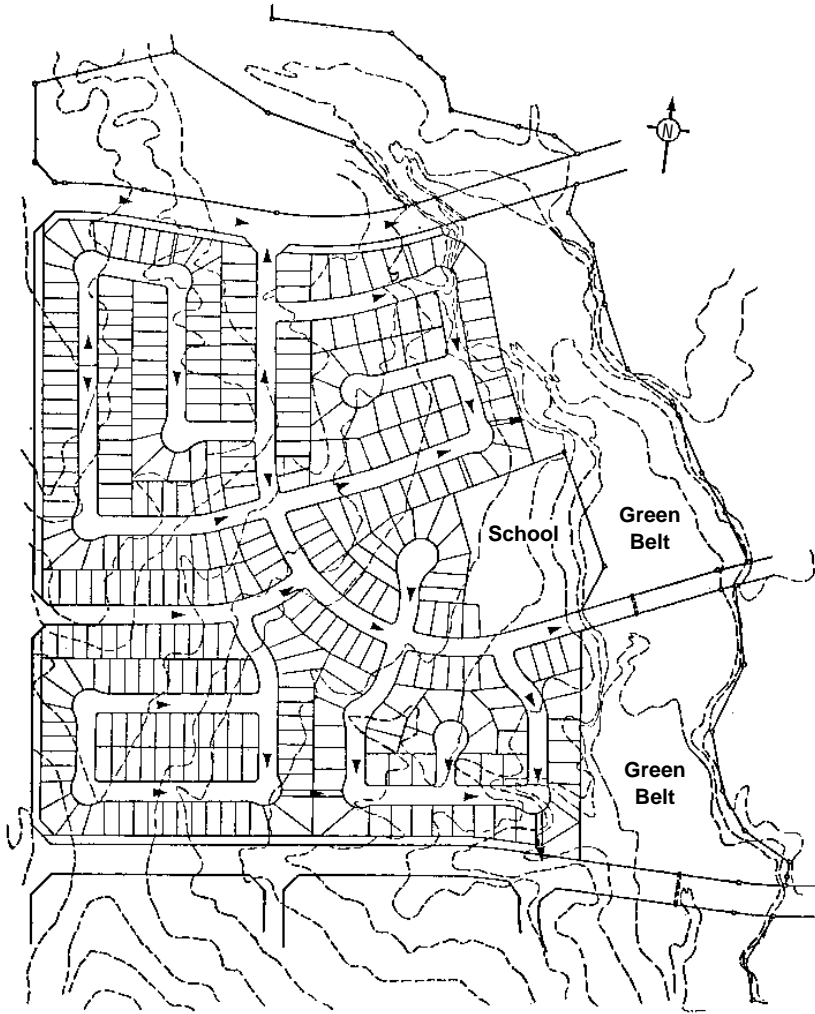


Figure 5.6 Site plan with route of surface runoff.

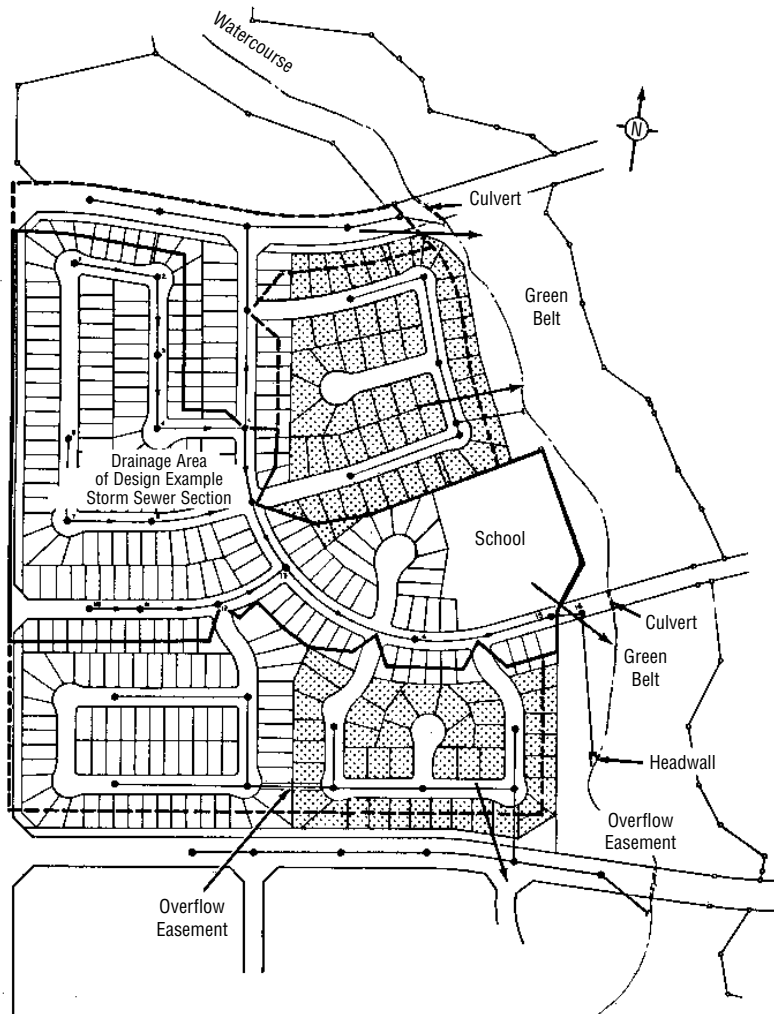


Figure 5.7 Storm drainage areas.

The major (or overflow) system will be checked together with the minor system against a 100-year storm intensity. The combination of these two systems shall be able to accommodate a 100-year storm runoff.

### Minor System

For the limited extent of area involved, designing on the principles of the minor-major drainage concept without gravity connections to foundation drains permits considerable tolerance in the degree of accuracy of runoff calculations such that the rational formula  $Q = k \cdot C \cdot i \cdot A$  is considered adequate. The values for the two-year rainfall intensity curve obtained from local records are shown in Table 5.5. The fol-

lowing steps should be followed in the hydraulic design of the minor system:

1. A drainage area map should be prepared indicating the drainage limits for the site, external tributary areas, location of imported minor system and carryover flows, proposed minor-major system layout and direction of surface flow.
2. The drainage area should be divided into sub-areas tributary to the proposed storm sewer inlets. In this case the inlet shall be located at the upstream end of each pipe segment.
3. The coverage of each sub-area should be calculated.

**Table 5.5 Rainfall Intensity Duration Frequency**

Time (Min)	2-Year Return		100 Year Return	
	(mm/hr)	(in./hr)	(mm/hr)	(in./hr)
5	105	4.15	262	10.33
10	72	2.85	178	7.04
15	57	2.25	146	5.74
20	48	1.88	122	4.80
25	42	1.65	109	4.30
30	37	1.47	97	3.81
35	34	1.32	89	3.50
40	30	1.20	81	3.20
45	28	1.10	74	2.90
50	26	1.04	69	2.70
55	24	0.96	64	2.50
60	22	0.98	59	2.31
65	21	0.81	55	2.15
70	19	0.75	51	2.00
75	18	0.69	47	1.85
80	16	0.63	44	1.75
85	15	0.58	41	1.63
90	13	0.53	39	1.55
95	12	0.49	38	1.50
100	11	0.45	33	1.30
125	10	0.40	32	1.27
150	9	0.35	25	1.00
175	7	0.31	23	0.90
200	7	0.27	22	0.86

4. The appropriate runoff coefficient should be developed for each sub-area. The example has been simplified in that impervious areas discharging to grass areas have been given a runoff coefficient equal to the grassed area runoff coefficient. The runoff coefficient in this example has been determined based on 0.20 for grassed areas and areas discharging to grass such as roof, patios and sidewalks) and 0.95 for impervious surfaces (streets and driveways), which for this site results in an average runoff coefficient of 0.35 for all the sub-areas.

5. The required capacity of each inlet should be calculated using the rational method, with the initial time of concentration and the corresponding intensity. In this example,

$$T_c = 10 \text{ minutes.}$$

$$i = 72 \text{ mm/hr (2.85 in./hr) for a 2-year storm (Table 5.5).}$$

Inlets will be located at the upstream manhole for each length of conduit.

6. Commencing at the upstream end of the system, the discharge to be carried by each successive segment in a downstream direction is calculated. The initial time of concentration is 10 minutes at the most up-stream inlet. Added to this value is the required travel time in the conduit to the next inlet. The resulting time of concentration is then used to determine a new intensity at that point.

Also, a weighted area  $\times$  C value must be determined at each successive inlet.

At a confluence of two or more conduits, the longest time of concentration is selected and the procedure continues downstream. The above computations are summarized in Table 5.6.

7. With computed discharges at the upstream end of each pipe segment, a tentative pipe size to accommodate friction losses only is selected using the friction flow charts in Chapter 4. In this design example, a helical 68 mm  $\times$  13 mm (2 2/3  $\times$  1/2 in.) CSP with variable roughness coefficient (Table 4.9) has been selected as the conduit material. The corresponding velocities for the expected flow are determined to calculate the pipe flow time. This time added to the upstream time of concentration results in the new time of concentration for the downstream segment as described in Step 6. Design velocities in storm sewers should be a minimum of 1.0 m/s (3 ft/s) when flowing half full to full to attain self cleaning velocities and to prevent deposition, to a maximum of 4.5 m/s (15 ft/s) to avoid erosive damage to the conduit.



Recharge trench installation showing junction box.



Culvert design technology and open-channel flow design are increasingly applied to urban storm water management. Triple structural plate pipe-arches enclose stream under roadway, and industrial land development.

*Note:* If upon completion of the hydraulic design (and backwater calculations) the times of concentrations have varied enough to alter the discharges, new flow values should be determined. In most cases the slight variance in the  $T_c$  will not significantly affect the peak flows.

8. As the preliminary design proceeds downstream, some account must be made for the manhole and junction losses. Certain rules of thumb may be used before the detailed hydraulic analysis. In this design example, the following manhole drops were assumed:

- 15 mm (0.05 ft) for straight runs
- 45 mm (0.15 ft) for 45° junctions
- 75 mm (0.25 ft) for 45° to 90° junctions

Also crowns of incoming and outgoing pipes at manholes were kept equal where the increase in downstream diameter met or exceeded the above manhole drops.

The preliminary minor system design is shown in Table 5.6 with the tentative pipe sizes and manhole drops.

9. The hydraulic analysis should next be performed on the proposed minor system to ensure that it operates as expected. The hydraulic grade is set at the crown of the outlet conduit, with hydraulic calculations proceeding upstream. The energy loss equations shall be used following the same procedure as in the Hydraulic section. The detailed hydraulic calculations are computed for each station, on pages 182 and 183, with the results summarized in Table 5.7. In this example the initial pipe sizes did not change, but rather manhole drops were adjusted to account for the junction losses. If junction losses had resulted in the elevation of the pipe crown exceeding the minimum cover criteria, then the hydraulic grade line may have been lowered by increasing the pipe





Increasers are easily fabricated for correct field location.

size. The hydraulic grade line may be permitted to exceed the crown where some surcharging in the storm system can be tolerated.

10. The designer may now estimate the required pipe sizes for a minor system for an alternative conduit material or roughness coefficient. There is no need to perform a detailed hydraulic analysis for the alternative conduit, but rather use the method of “Equivalent Alternatives” as described earlier in this chapter. In this example, the average length of conduit is estimated to be 90 m (300 ft) with an average manhole junction loss coefficient of 1.0. The alternative conduit will have constant  $n = .012$ . Therefore the alternative material may be determined. The results are summarized in Table 5.8.



Large storm drain projects under runways at a major airport.

**Table 5.6M Preliminary Storm Sewer Design**

Location		Runoff	Length			Total Section A x C	Total Trunk A x C	Intensity I	Flow Q	Length of Pipe	Size Pipe	Slope %	Fall	M.H. Drop	Inverts		Actual Cap.	Vel.	Time (Entry: 10min)	
Street	M.H. From	M.H. To	Area	C	A x C										Up Stream	Down Stream			Sect. Min.	Accum. Min.
			(ha)				(mm/hr)	(m <sup>3</sup> /s)	(m)	(mm)		(m)	(mm)	(m)	(m)	(m <sup>3</sup> /s)	(m/s)			
	1	2	0.74	0.35	0.26	0.26		72	0.05	90	200	0.84	0.76		231.590	230.830	0.05	1.03	1.47	11.47
	2	3	1.10	0.35	0.39	0.65		67	0.12	80	300	1.30	1.04	75	230.755	229.715	0.12	1.71	0.77	12.24
	3	4	1.04	0.35	0.36	1.01		65	0.18	81	400	0.98	0.79	75	229.640	228.850	0.18	1.58	0.85	13.09
	4	5	0.83	0.35	0.29	1.30		62	0.22	93	400	1.50	1.30	75	228.775	227.475	0.22	1.96	0.79	13.88
	6	7	1.06	0.35	0.37	0.37		72	0.07	90	200	1.70	1.53		231.610	230.080	0.07	1.47	1.04	11.04
	7	8	–	–	–	–		–	0.07	90	200	1.70	1.53	75	230.005	228.475	0.07	1.47	1.04	12.08
	8	9	1.50	0.35	0.53	0.90		66	0.16	75	300	2.20	1.65	45	228.430	226.780	0.16	2.23	0.56	12.64
	10	11	1.80	0.35	0.63	0.63		72	0.13	90	300	1.40	1.26		230.360	229.100	0.13	1.77	0.86	10.86
	11	12	0.71	0.35	0.25	0.88		69	0.17	83	300	2.40	1.99	15	229.085	227.095	0.17	2.32	0.60	11.46
	12	13	0.42	0.35	0.15	1.03		67	0.19	81	400	1.10	0.89	75	227.020	226.130	0.19	1.68	0.80	12.26
	5	9	0.43	0.35	0.15		1.45	60	0.24	81	500	0.76	0.62	75	227.400	226.780	0.24	1.47	0.92	14.80
	9	13	0.53	0.35	0.19		2.54	58	0.40	81	600	0.62	0.50	150	226.630	226.130	0.41	1.41	0.96	15.76
	13	14	2.28	0.35	0.80		4.37	56	0.67	150	600	1.70	2.55	75	226.055	223.505	0.68	2.32	1.09	16.85
	14	15	0.55	0.35	0.19		4.56	55	0.69	150	600	1.80	2.70	15	223.490	220.790	0.70	2.39	1.06	17.91
	15	16	2.35	0.20	0.47		5.03	53	0.74	35	700	1.20	0.42	75	220.715	220.295	0.74	1.99	0.28	18.19
	16	Outfall	–	–	–		5.03	53	0.74	150	800	0.68	1.02	75	220.220	219.200	0.74	1.61	1.58	19.77

**Note:** Diameters of 400, 500, 700, and 800 mm are non-standard. Standard sizes are 375, 525, 675, and 825 mm.

Q = Flow

C = Coefficient of Runoff

A = Area in Hectares

I = Intensity of Rainfall for Period in mm/h

**Table 5.6 Preliminary Storm Sewer Design**

Location		Runoff		Length			Total Section A x C	Total Trunk A x C	Intensity I	Flow Q	Length of Pipe	Size Pipe	Slope %	Fall	M.H. Drop	Inverts		Actual Cap.	Vel.	Time (Entry: 10min)	
Street	M.H. From	M.H. To	Area A	C	A x C	Up Stream										Down Stream	Sec. Min.			Accum. Min.	
				(ha)				(in./hr)	(ft <sup>3</sup> /s)	(ft)	(in.)		(ft)	(ft)	(ft)	(ft)	Q(ft <sup>3</sup> /s)	(ft/s)			
	1	2	1.82	0.35	0.64	0.64		2.85	1.82	300	10"	0.84	2.52			771.71	769.19	1.85	3.39	1.47	11.47
	2	3	2.73	0.35	0.96	1.60		2.65	4.24	260	12"	1.30	3.38	.25		768.94	765.58	4.40	5.61	0.77	12.24
	3	4	2.57	0.35	0.90	2.50		2.56	6.40	265	15"	1.50	4.59	.25		762.46	757.87	7.92	6.44	0.79	13.88
	4	5	2.06	0.35	0.72	3.22		2.46	7.92	306	15"	1.50	4.59	.25		762.46	757.87	7.92	6.44	0.79	13.88
	6	7	2.63	0.35	0.92	0.92		2.85	2.62	300	10"	1.70	5.10			771.62	766.52	2.63	4.83	1.04	11.01
	7	8	—	—	—	—		—	2.62	300	10"	1.70	5.10	.25		766.27	761.17	2.63	4.83	1.04	11.04
	8	9	3.70	0.35	1.30	2.22		2.58	5.73	245	12"	2.20	5.39	.17		761.00	755.61	5.73	7.30	0.56	12.64
	10	11	4.46	0.35	1.56	1.56		2.85	4.45	300	12"	1.40	4.20			767.54	763.34	4.57	5.82	0.86	10.86
	11	12	1.76	0.35	0.62	2.18		2.73	5.95	275	12"	2.40	6.60	.05		763.29	756.69	5.98	7.62	0.60	11.46
	12	13	1.05	0.35	0.37	2.55		2.65	6.76	265	15"	1.10	2.92	.25		756.44	753.52	6.78	5.51	0.80	12.26
	5	9	1.06	0.35	0.37		3.59	2.37	8.51	265	18"	0.76	2.01	.25		757.62	755.61	8.51	4.81	0.92	14.88
	9	13	1.32	0.35	0.46		6.27	2.27	14.23	265	24"	0.62	1.59	.50		755.11	753.52	14.46	4.61	0.96	15.76
	13	14	5.64	0.35	0.46		6.27	2.27	14.23	265	24"	1.70	8.50	.25		753.27	744.77	23.89	7.61	1.09	16.85
	14	15	1.37	0.35	0.48		11.27	2.16	24.34	500	24"	1.80	9.00	.05		744.72	735.72	24.62	7.84	1.06	17.91
	15	16	5.81	0.20	1.16		12.43	2.09	25.98	110	27"	1.20	1.32	.25		735.47	734.15	25.98	6.53	0.28	18.19
	16	Outfall	—	—	—		12.43	2.09	25.98	500	30"	.068	3.40	.25		733.90	730.50	25.98	5.29	1.58	19.77

**Note:** A = Area in Hectares      C = Coefficient of Runoff  
I = Intensity of Rainfall for Period in mm/h

**Table 5.7M Hydraulic Calculation Sheet**

1	2	3	4	5	6	7	8	9	10	11	12	13	14	15	16	17	18	19	20
M.H.	Invert	D	H.G.	Section	A	K	V	Q	V <sup>2</sup>	E.G.	S <sub>f</sub>	Avg.S <sub>t</sub>	L	H <sub>t</sub>	H <sub>b</sub>	H <sub>j</sub>	H <sub>m</sub>	H <sub>t</sub>	E.G.
	(m)	(mm)	(m)		(m <sup>2</sup> )		(m/s)	(m <sup>3</sup> /s)	(2/g)	(m)	(mm)	(m/m)	(m)	(m)	(m)	(m)	(m)	(m)	(m)
Outlet	219.200	800	220.000	0	0.50	0.00636	1.473	0.74	0.111	220.111	0.0060								220.111
16	220.149	800	220.949	0	0.50	0.00636	1.473	0.74	0.111	221.060	0.0060	0.0060	150	0.900	0.033			0.016	221.060
15	220.593	700	221.293	0	0.38	0.00636	1.924	0.74	0.189	221.482	0.0123	0.0092	35	0.322				0.022	221.482
14	223.478	600	224.078	0	0.28	0.00636	2.442	0.69	0.304	224.382	0.0243	0.0183	150	2.745	0.025		0.015		224.382
13	227.428	600	228.028	0	0.028	0.00636	2.371	0.67	0.287	228.315	0.0229	0.0236	150	3.540	0.034	0.376			228.315
9	228.912	600	229.512	0	0.28	0.00636	1.415	0.40	0.102	229.614	0.081	0.0155	81	1.256	0.008	0.220			229.614
5	229.586	500	230.086	0	0.20	0.00441	1.223	0.24	0.076	230.162	0.0054	0.0068	81	0.551	0.007			0.016	230.162
12	228.994	400	229.394	0	0.13	0.00385	1.513	0.19	0.117	229.511	0.0097	0.0163	81	1.320	0.01			0.036	229.511
11	230.798	300	231.098	0	0.07	0.00332	2.406	0.17	0.295	231.393	0.0310	0.0204	83	1.689			0.015		231.393
10	233.182	300	233.482	0	0.07	0.00332	1.840	0.13	0.173	233.655	0.0182	0.0246	90	2.214			0.17		233.655
8	230.579	300	230.879	0	0.07	0.00332	2.265	0.16	0.261	231.140	0.0274	0.0178	75	1.335	0.031		0.001		231.140
7	233.927	200	234.127	0	0.03	0.00283	2.229	0.07	0.253	234.380	0.0389	0.0332	90	2.988	0.26				234.380
6	237.678	200	237.878	0	0.06	0.00283	2.229	0.07	0.253	238.131	0.0389	0.0389	90	3.501			0.25		238.131
4	230.708	400	231.108	0	0.13	0.00385	1.752	0.22	0.156	231.264	0.0129	0.0092	93	0.856	0.166				231.264
3	231.593	400	231.993	0	0.13	0.00385	1.433	0.18	0.105	232.098	0.0087	0.0108	81	0.875				0.01	232.098
2	232.737	300	233.037	0	0.07	0.00332	1.700	0.12	0.147	233.184	0.0154	0.0121	80	0.968	0.074			0.002	233.184
1	234.551	200	234.751	0	0.03	0.00283	1.592	0.05	0.129	234.880	0.0198	0.0176	90	1.584			0.13		234.880

**Note:** Diameters of 400, 500, 700, and 800 mm are non-standard.  
Standard sizes are 375, 525, 675, and 825 mm.

**Table 5.7 Hydraulic Calculation Sheet**

1	2	3	4	5	6	7	8	9	10	11	12	13	14	15	16	17	18	19	20
M.H.	Invert	D	H.G.	Section	A	K	V	Q	V <sup>2</sup>	E.G.	S <sub>f</sub>	Avg.S <sub>f</sub>	L	H <sub>t</sub>	H <sub>b</sub>	H <sub>j</sub>	H <sub>m</sub>	H <sub>t</sub>	E.G.
	(ft)	(in.)	(ft)		(ft <sup>2</sup> )		(ft/s)	(ft <sup>3</sup> /s)	(ft)	(ft)		(ft/ft)	(ft)	(ft)	(ft)	(ft)	(ft)	(ft)	(ft)
Outlet	730.50	30"	733.00	0	4.91	.0084	5.29	25.98	.43	733.43									733.43
16	734.08	30"	736.58	0	4.91	.0084	5.29	25.98	.43	737.01		.0068	500	3.40	.129'			.046	737.01
15	735.48	27"	737.73	0	3.976	.0084	6.53	25.98	.66	738.39		.0120	110	1.32				.058	738.39
14	744.57	24"	746.57	0	3.14	.0075	7.84	24.34	.95	747.52		.0180	500	9.00	.079		.048		747.52
13	753.86	24"	755.86	0	3.14	.0075	7.61	23.74	.90	756.76		.0170	500	8.50	.106	1.137			756.76
9	755.85	24"	758.85	0	3.14	.0075	4.61	14.23	.33	759.18		.0062	265	1.59	.028	.798			759.18
5	759.79	18"	761.29	0	1.77	.0057	4.81	8.51	.36	761.65		.0076	265	2.01	.404			.056	761.65
12	758.09	15"	759.34	0	1.23	.0049	5.51	6.76	.47	759.81		.0110	265	2.92	.039			.086	759.81
11	764.56	12"	765.56	0	0.785	.0042	7.62	5.95	.90	766.46		.0240	275	6.60			.045		759.81
10	769.66	12"	770.66	0	0.785	.0042	5.82	4.45	.53	771.19		.0140	300	4.20			.530		771.19
8	762.89	12"	763.89	0	0.785	.0042	7.30	5.73	.83	764.72		.0220	245	5.39	.098		.047		764.72
7	768.99	10"	769.83	0	0.545	.0057	4.83	2.62	.36	770.19		.0170	300	5.10	.374				770.19
6	774.46	10"	775.29	0	0.545	.0057	4.83	2.62	.36	775.65		.0170	300	5.10			.360		775.65
4	765.02	15"	766.27	0	1.23	.0049	6.44	7.92	.64	766.91		.0150	306	4.59	.666				766.91
3	767.85	15"	769.10	0	1.23	.0049	5.20	6.40	.42	769.52		.0098	265	2.60				.014	769.52
2	771.68	12"	772.68	0	0.785	.0042	5.61	4.24	.49	773.17		.0084	300	2.52	.240		.180	.031	773.17
1	774.86	10"	775.69	0	0.545	.0057	3.39	1.82	.18	775.87		.0084	300	2.52					775.87

**Note:**

n = Variable

$$K = \frac{2g(n^2)}{2.21}$$

$$S_f = K \left( \frac{V^2}{2g} \right) \div R^{4/3}$$

### Detailed Metric Hydraulic Calculations for Step No. 9 in Minor System Design

M.H. 16  $\theta = 45^\circ$

From Figure 4.13  $K = 0.3$

$$\therefore H_b = K \left( \frac{V^2}{2g} \right) = 0.3 \times 0.11 = 0.033 \text{ m}$$

$$H_t = 0.2 \left( \frac{V_1^2}{2g} - \frac{V_2^2}{2g} \right) = 0.2 \times (.19 - .11) = 0.016 \text{ m (0.046 ft)}$$

M.H. 15  $H_t = 0.2 \left( \frac{V_1^2}{2g} - \frac{V_2^2}{2g} \right) = 0.2 \times (.30 - .19) = 0.022 \text{ m (0.058 ft)}$

M.H. 14  $H_t = 0.25 \sqrt{\frac{10}{90}}$

$$H_b = K_b \left( \frac{V^2}{2g} \right) = 0.083 \times .30 = 0.025 \text{ m (.079 ft)}$$

$$H_m = 0.05 \left( \frac{V^2}{2g} \right) = 0.05 \times .30 = 0.015 \text{ m (.048 ft)}$$

M.H. 13  $H_b = 0.25 \sqrt{\frac{20}{90}} = 0.117$

$$H_b = K_b \left( \frac{V^2}{2g} \right) = 0.117 \times (.29) = 0.034 \text{ m (.106 ft)}$$

$$(H_j + D_1 - D_2) \left( \frac{A_1 + A_2}{2} \right) = \frac{Q_2^2}{gA_2} - \frac{Q_1^2}{gA_1} - \frac{Q_3^2}{gA_3} \cos \theta$$

$$\therefore \theta = 90^\circ \quad \cos 90^\circ = 0$$

$$(H_j + 0.6 - 0.6) \left( \frac{0.28 + 0.28}{2} \right) = \frac{(0.67)^2}{9.81 (0.28)} - \frac{(0.4)^2}{9.81 (0.28)}$$

$$H_j = 0.376 \text{ m (1.137 ft)}$$

M.H. 9  $H_b = K_b \frac{V^2}{2g} = \left( 0.25 \sqrt{\frac{10}{90}} \right) \times 0.10 = 0.008 \text{ m (.028 ft)}$

$$\therefore \theta = 90^\circ \quad \cos 90^\circ = 0$$

$$\therefore (H_j + 0.5 - 0.6) \left( \frac{0.20 + 0.28}{2} \right) = \frac{(0.4)^2}{9.81 (0.28)} - \frac{(0.24)^2}{9.81 (0.20)}$$

$$H_j = 0.220 \text{ m (.798 ft)}$$

M.H. 5  $\theta = 90^\circ$

$$H_b = K_b \frac{V^2}{2g} = \left(0.25 \sqrt{\frac{10}{90}}\right) \times 0.08 = 0.007 \text{ m (.404 ft)}$$

$$H_t = 0.2 \left( \frac{V_1^2}{2g} - \frac{V_2^2}{2g} \right) = 0.2 (.16 - .08) = 0.016 \text{ m (.056 ft)}$$

M.H. 12

$$H_b = \left(0.25 \sqrt{\frac{10}{90}}\right) \times .12 = 0.010 \text{ m (.039 ft)}$$

$$H_t = 0.2 (0.3 - 0.12) = 0.036 (.086)$$

M.H. 11

$$H_m = 0.05 \left( \frac{V^2}{2g} \right) = 0.05 (.03) = 0.015 \text{ m (.045 ft)}$$

M.H. 10

$$K = 1.0$$

$$H_m = K \left( \frac{V^2}{2g} \right) = 1.0 (0.17) = 0.17 \text{ m (.530 ft)}$$

M.H. 8

$$H_b = \left(0.25 \sqrt{\frac{20}{90}}\right) (.26) = 0.031 \text{ m (.098 ft)}$$

$$H_m = 0.1 \left( \frac{V_2^2}{2g} - \frac{V_1^2}{2g} \right) = 0.1 (.26 - .25) = 0.001 \text{ m (.047 ft)}$$

M.H. 7

$$\theta = 90^\circ$$

From Figure 4.13  $K = 1.04$

$$H_b = 1.04 (0.25) = 0.260 \text{ m (.374 ft)}$$

M.H. 6

$$K = 1.0$$

$$H_m = K \left( \frac{V^2}{2g} \right) = 1.0 (0.25) = 0.250 \text{ m (.36 ft)}$$

M.H. 4

$$\theta = 90^\circ$$

From Figure 4.13  $K = 1.04$

$$H_b = 1.04 (0.16) = 0.166 \text{ m (.666 ft)}$$

M.H. 3

$$H_t = 0.2 \left( \frac{V_2^2}{2g} - \frac{V_1^2}{2g} \right) = 0.2 (.15 - .10) = 0.010 \text{ m (.014 ft)}$$

M.H. 2

$$\theta = 60^\circ$$

From Figure 4.13  $K = 0.49$

$$H_b = 0.49 (0.15) = 0.074 \text{ m (.240 ft)}$$

$$H_t = 0.1 \left( \frac{V_2^2}{2g} - \frac{V_1^2}{2g} \right) = 0.002 \text{ m (.031 ft)}$$

M.H. 1

$$K = 1.0$$

$$H_m = K \left( \frac{V^2}{2g} \right) = 1.0 \times 0.13 = 0.13 \text{ m (.18 ft)}$$

**Table 5.8** Equivalent Alternative n = .012

Location				
Street	M.H. From	M.H. To	Pipe Size*	
			(mm)	(in.)
	1	2	200	10
	2	3	300	12
	3	4	400	15
	4	5	400	15
	6	7	200	10
	7	8	200	10
	8	9	300	12
	10	11	300	12
	11	12	300	12
	12	13	400	15
	5	9	500	18
	9	13	600	24
	13	14	600	24
	14	15	600	24
	15	16	700	24
	16	Outfall	800	27

**Notes:** \*Diameters of 400, 500, 700, and 800 mm are non-standard.  
Standard sizes are 375, 525, 675, and 825 mm.

## Major System

Various manual methods can be used to estimate the major system flows. As a preliminary estimate, designers often apply the Rational formula, using the rainfall intensity for a 100-year storm and a C factor 60% to 85% higher than what would be used for a 2-year or 5-year storm. The increase in value is basically to allow for a change in the antecedent moisture condition. Except in special circumstances, a C factor above 0.85 need not be used.

In this design example, the C factor of 0.35 used for the design of the minor system will be increased to 0.60, an increase of about 70%. The results are shown in Table 5.9.

In cases where this method results in flows in excess of the acceptable roadway capacity, a more detailed method should be applied, such as the SCS Graphical Method or a suitable hydrological computer model.

If properly laid out, the major system can tolerate the variability in flows estimated by the various methods. A minor increase in the depth of surface flow will greatly increase the capacity of the major system, without necessarily causing serious flooding. The designer must also consider the remaining overland flow accumulated at the downstream end of the development; adequate consideration must be given for its conveyance to the receiving water body. This may involve increasing the minor system and inlet capacities or providing adequate drainage swales.

## Foundation Drains

To establish the groundwater level, piezometer measurements over a 12 month period were taken, indicating the groundwater table would be safely below the footing elevations for the proposed buildings, minimizing the amount of inflow that can be expected into the foundation drains.

The municipal requirements include detailed lot grading control, thus further reducing the possibility of surface water entering the foundation drains. Accordingly a flow value of  $7.65 \times 10^{-5} \text{ m}^3/\text{s}$  ( $0.0027 \text{ ft}^3/\text{s}$ ) per basement is used. See the discussion on Foundation Drains in Chapter 2 of this text. For detailed calculations see Table 5.10.



**Table 5.9M Major System Flows For 100-Year Storm**

Location MH to MH	Runoff			Total Section A x C	Time of Concentration	Intensity I	Total Runoff Q	Sewer* Capacity	Major System (overland flow)	Road Grade	Surface Capacity**
	Area, A	C	A x C								
	(ha)				(min)	(mm/hr)	(m <sup>3</sup> /s)	(m <sup>3</sup> /s)	(m <sup>3</sup> /s)	%	(m <sup>3</sup> /s)
1-2	0.74	0.60	0.44	0.44	10.0	179	0.22	0.07	0.15	2.00	5.15
2-3	1.10	0.60	0.66	1.10	11.5	174	0.53	0.11	0.42	2.00	5.15
3-4	1.04	0.60	0.62	1.72	12.8	160	0.76	0.14	0.63	2.00	5.15
4-5	0.83	0.60	0.50	2.22	14.2	151	0.93	0.14	0.79	1.90	5.09
6-7	1.06	0.60	0.64	0.64	10.0	179	0.31	0.11	0.21	2.00	5.15
7-8	—	—	—	—	11.5	169	0.00	0.00	0.00	2.20	5.41
8-9	1.50	0.60	0.90	1.54	13.0	159	0.67	0.14	0.53	2.00	5.15
10-11	1.80	0.60	1.08	1.08	10.0	179	0.53	0.13	0.41	1.85	4.96
11-12	0.71	0.60	0.43	1.51	11.5	169	0.70	0.14	0.57	2.00	5.15
12-13	0.42	0.60	0.25	1.76	12.0	160	0.78	0.12	0.66	2.20	5.41
5-9	0.43	0.60	0.26	2.48	15.7	142	0.98	0.12	0.85	2.00	7.79
9-13	0.53	0.60	0.32	3.62	17.1	136	1.36	0.12	1.24	2.00	7.79
13-14	2.28	0.60	1.37	6.75	18.4	130	2.41	0.22	2.19	2.50	8.78
14-15	0.55	0.60	0.33	7.08	20.9	120	2.34	0.23	2.11	2.00	7.79
15-16	2.35	0.60	1.41	8.49	23.4	113	2.65	0.23	2.43	0.50	3.96
16-Outfall	—	—	—	8.49	24.0	112	2.62	0.23	2.39	0.50	3.96

**Notes:** \* Assuming sufficient inlet capacity

**Table 5.9 Major System Flows For 100-Year Storm**

Location MH to MH	Runoff			Total Section A x C	Time of Concentration	Intensity I	Total Runoff Q	Sewer* Capacity	Major System (overland flow)	Road Grade	Surface Capacity**
	Area, A	C	A x C								
	(acres)				(min)	(in./hr)	(ft <sup>3</sup> /s)	(ft <sup>3</sup> /s)	(ft <sup>3</sup> /s)	%	(ft <sup>3</sup> /s)
1-2	1.82	0.60	1.09	1.09	10.0	7.04	7.67	2.54	5.13	2.00	182.0
2-3	2.73	0.60	1.64	2.73	11.5	6.85	18.70	3.94	14.76	2.00	182.0
3-4	2.57	0.60	1.54	4.27	12.8	6.30	26.90	4.80	22.10	2.00	182.0
4-5	2.06	0.60	1.24	5.51	14.2	5.95	32.78	5.00	27.78	1.90	180.0
6-7	2.63	0.60	1.58	1.58	10.0	7.04	11.12	3.74	7.38	2.00	182.0
7-8	—	—	—	—	11.5	6.65	0.00	0.00	0.00	2.20	191.0
8-9	3.70	0.60	2.22	3.80	13.0	6.26	23.79	4.90	18.89	2.00	182.0
10-11	4.46	0.60	2.68	2.68	10.0	7.04	18.87	4.50	14.37	1.85	175.0
11-12	1.76	0.60	1.06	3.74	11.5	6.65	24.87	4.80	20.07	2.00	182.0
12-13	1.05	0.60	0.63	4.37	12.0	6.28	27.44	4.30	23.14	2.20	191.0
5-9	1.06	0.60	0.64	6.15	15.7	5.60	34.44	4.30	30.14	2.00	275.0
9-13	1.32	0.60	0.79	8.96	17.1	5.35	47.94	4.30	43.64	2.00	275.0
13-14	5.64	0.60	3.38	16.71	18.4	5.10	85.22	7.80	77.42	2.50	310.0
14-15	1.37	0.60	0.82	17.53	20.9	4.71	82.57	7.95	74.62	2.00	275.0
15-16	5.81	0.60	3.49	21.02	23.4	4.46	93.75	7.95	85.80	0.50	140.0
16-Outfall	—	—	—	21.02	24.0	4.40	92.49	7.95	84.85	0.50	140.0

**Notes:** \* Assuming sufficient inlet capacity

### Computer Models

There is a wide range of computer models now available for analyzing sewer networks. The complexity of the models varies from straightforward models, which use the rational method to estimate the peak flow to comprehensive models that are based on the continuity and momentum equations and are capable of modeling surcharge, backwater, orifices, weirs and other sewer components. Table 5.11 lists several of these models and their capabilities.



Smooth-lined CSP storm sewer being installed.

**Table 5.10M Foundation Drain Collector Design Sheet**

Location	From M.H.	To M.H.	Unit Area	Density	Total Units	Cum. Units	Flow Per Unit	Total Flow	Length (m)	Gradient (%)	Pipe Dia. (mm)	Capacity (m <sup>3</sup> /s)	Velocity (m/s)
			(ha)	(per ha)			(m <sup>3</sup> /sx10 <sup>-5</sup> )	(m <sup>3</sup> /sx10 <sup>-3</sup> )					
Crescent 'G'	1A	2A	1.20	2	18	18	7.65	1.38	119	0.98	200	0.031	1.12
'G'	2A	3A	0.72	2	11	29	7.65	2.22	94	1.51	200	0.037	1.37
'G'	3A	4A	1.49	2	22	51	7.65	3.90	152	0.50	200	0.022	0.79
'G'	4A	5A	0.60	2	9	60	7.65	4.59	93	0.55	200	0.023	0.82
'G'	1A	6A	1.52	2	23	23	7.65	1.76	152	1.39	200	0.036	1.28
'G'	6A	7A	0.93	2	14	37	7.65	2.83	90	2.25	200	0.040	1.67
'G'	7A	8A	0.58	2	9	46	7.65	3.52	105	1.31	200	0.035	1.28
Street 'F'	9A	10A	1.54	3	30	30	7.65	2.30	137	1.20	200	0.034	1.21
'F'	10A	11A	0.85	3	17	47	7.65	3.60	133	1.20	200	0.034	1.21
Street 'A'	5A	8A	0.63	3	13	106	7.65	8.11	82	1.81	200	0.041	1.52
'A'	8A	11A	0.51	3	10	116	7.65	8.87	75	4.34	200	0.063	2.31
'A'	11A	13A	0.94	3	19	135	7.65	10.30	133	1.42	200	0.036	1.34

**Source:** Paul Theil Associates Ltd.

**Table 5.10 Foundation Drain Collector Design Sheet**

Location	From M.H.	To M.H.	Unit Area	Density	Total Units	Cum. Units	Flow Per Unit	Total Flow	Length (ft)	Gradient (%)	Pipe Dia. (in.)	Capacity (ft <sup>3</sup> /s)	Velocity (ft/s)
			(acres)	(per acre)			(ft <sup>3</sup> /s)	(ft <sup>3</sup> /s)					
Crescent 'G'	1A	2A	2.97	6	18	18	0.0027	0.0048	390	0.98	8	1.08	3.7
'G'	2A	3A	1.78	6	11	29	0.0027	0.078	310	1.51	8	1.32	4.5
'G'	3A	4A	3.68	6	22	51	0.0027	0.138	500	0.50	8	0.76	2.6
'G'	4A	5A	1.48	6	9	60	0.0027	0.162	306	0.55	8	0.80	2.7
'G'	1A	6A	3.75	6	23	23	0.0027	0.062	500	1.39	8	1.28	4.2
'G'	6A	7A	2.30	6	14	37	0.0027	0.023	295	2.25	8	1.62	5.5
'G'	7A	8A	1.43	6	9	46	0.0027	0.124	345	1.31	8	1.24	4.2
Street 'F'	9A	10A	3.80	8	30	30	0.0027	0.081	450	1.20	8	1.19	4.0
'F'	10A	11A	2.10	8	17	47	0.0027	0.127	435	1.20	8	1.19	4.0
Street 'A'	5A	8A	1.56	8	13	106	0.0027	0.286	268	1.81	8	1.45	5.0
'A'	8A	11A	1.27	8	10	116	0.0027	0.313	245	4.34	8	2.23	7.6
'A'	11A	13A	2.33	8	19	135	0.0027	0.365	435	1.42	8	1.28	4.4

**Source:** Paul Theil Associates Ltd.

**Table 5.11 Computer Models — Sewer System Design and Analysis**

	CE Storm <sup>2</sup>	HVM Dorsch <sup>3</sup>	ILLUDAS <sup>4</sup>	SWMM-Extran <sup>5</sup>	SWMM-Transport <sup>5</sup>	WASSP-SIM <sup>6</sup>	WSPRO
<b>Model Characteristics</b>							
<b>Model Purpose:</b> Hydraulic Design Evaluation/Prediction	•	•	•	•	•	•	•
<b>Model Capabilities:</b> Pipe Sizing Weirs/Overflows Surcharging Pumping Stations Storage Open Channel Water Surface Profile	•	•	•	•	•	•	•
<b>Hydraulic Equations:</b> Linear Kinematic Wave Non-Linear Kinematic Wave St. Venant's - Explicit St. Venant's - Implicit	•	•	•	•	•	•	
<b>Ease of Use:</b> High Low	•	•	•	•	•	•	•

## REFERENCES

1. Wright, K.K., *Urban Storm Drainage Criteria Manual, Volume I*, Wright-McLaughlin Engineers, Denver, Colorado, 1969.
2. Dept. of the Army, *CE Storm Users Manual*, Construction Engineering Research Laboratory, Champaign, Illinois, 1985.
3. *Hydrograph Volume Method of Sewer System Analysis, HVM Manual*, Dorsch Consult Limited, Federal Republic of Germany, 1987.
4. Terstriep, M.L., Stall, J.B., *Illinois Urban Drainage Area Simulator (ILLUDAS)*, Illinois State Water Survey, Bulletin 58, Urbana, Illinois, 1974.
5. Huber, W.C. Heaney, J.P. and Cunningham, B.A., *Stormwater Management Model (SWMM Version IV) Users Manual*, U.S. Environmental Protection Agency, 1986.
6. *Wallingford Storm Sewer Package (WASSP), Users Guide*, Hydraulics Research Laboratory, Wallingford, UK, 1984.





Two 6 m (20 ft) joints of perforated pipe banded together for ease of installation.



# Stormwater Detention & Subsurface Disposal

---

## STORMWATER DETENTION FACILITIES

Detention facilities in new storm drain age systems are increasing in popularity as a means of achieving the urban drain age objectives. Detention facilities may also be incorporated into existing developments where flooding problems due to sewer surcharging are occurring. Each proposed development should be carefully examined in order to determine which method of storm water detention or combination of methods could be best applied. The methods of detention available may be categorized under three classifications: 1) underground, 2) surface, 3) roof top.

### **Underground Detention**

In areas where surface ponds are either not permitted or not feasible, underground detention may be used. Excess storm water will be accommodated in some form of storage tank, either in line or off line, which will discharge at a pre-determined control rate back into either the sewer system or open watercourse. In-line storage incorporates the storage facility directly into the sewer system. Should the capacity of the storage facility be exceeded, it will result in sewer surcharging.

Off-line detention collects storm water runoff before it enters the minor system and then discharges it into either a sewer or open water course at a controlled rate. By making use of the major system and connecting all tributary catch basins to a detention tank, approximately 80% of storm runoff may be prevented from directly entering conventional sewer systems. In areas where roof drains are discharged to the surface, close to 100% of the storm runoff may be controlled. Such facilities are very applicable in areas with a combined sewer system. In such cases, catch basins may be sealed where positive overland drainage is assured. Storm water is then collected in underground storage tanks and discharged back to the combined sewer at a controlled rate (see Figure 6.1).

### **Surface Detention**

Surface detention is feasible in developments where open spaces exist. Parking lots provide a very economical method of detaining peak runoff when the rate of runoff reaches a predetermined level. The areas to be ponded should be placed so pedestrians can reach their destinations without walking through the ponded water. Areas used for overflow parking or employee parking are best suited. The maximum depth of ponding would vary with local conditions, but should not be more than 200 mm (8 in.) to prevent damage to vehicles. Overflow arrangements must be made to prevent the water depth exceeding the predetermined maximum. Ponds either wet or dry may be located on open spaces or parklands to control runoff. Wet ponds hold water during dry periods, thus they may serve other purposes such as recreational and aesthetic. Trapped storm water might also be reused for lawn watering and irrigation. A detention basin will act as a "cushion," which will have the effect of decreasing the peak runoff, removing sediments and reducing pollutants before discharge to streams and lakes.

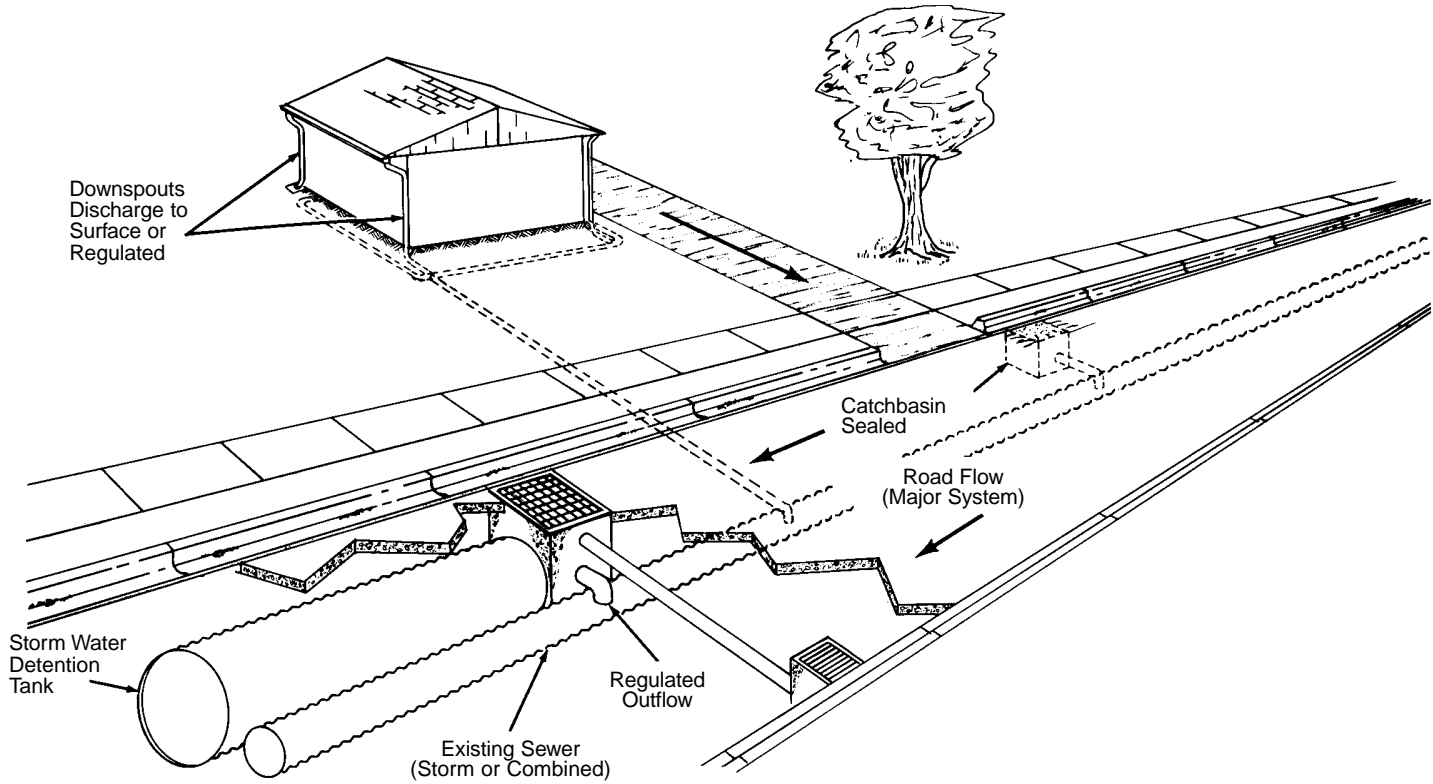


Figure 6.1 Inlet control system.

Dry ponds are operable during and a short time after a storm event. Since these facilities are designed to drain completely, they may serve other functions such as golf courses, parks, playing fields, etc.<sup>1</sup>

### Roof Top Detention

Flat roofs are very common for industrial, commercial and apartment buildings. Since they are often designed for snow load, they will also accommodate an equivalent load of water without any structural changes. A 150 mm (6 in.) water depth is equivalent to 150 kg/m<sup>2</sup> (31.2 lb/ft<sup>2</sup>) less than most snow load requirements in northern United States and Canada.

Special roof drains with controlled outlet capacity have been used for many years to reduce the size of drainage pipe within an individual building or site. Seldom was this reduction in peak flow recognized in the sizing of the municipal storm sewers, and the total benefit was therefore not achieved. Many flat roofs now also pond significant amounts of storm water; this should also be considered when estimating peak flows. By installing roof drains with controlled outlet capacity, the resultant peak runoff from a roof can be reduced by up to 90 %, a very significant reduction indeed. In addition to this important advantage, it is obvious that there would be substantial cost savings. For a typical roof drain with controlled outflow, see Figure 6.2.

Overflow mechanisms should be provided so that the structural capacity of the roof is not exceeded. Also, special consideration should be given to water tightness when roof top ponding is to be incorporated.



2700 mm (108 in.) diameter CSP used as an underground detention chamber. The outlet control structure is located at the opposite end and to the right of those pipes.

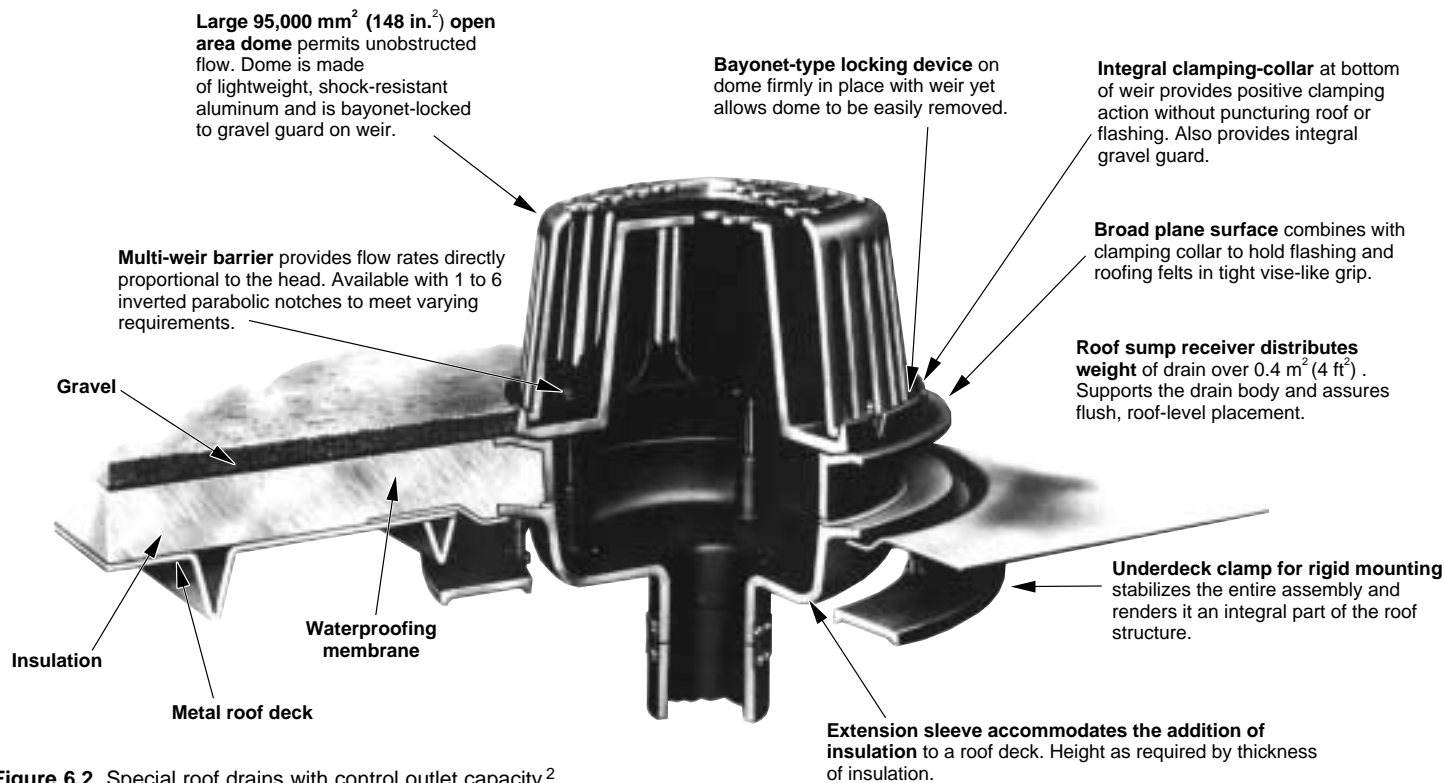


Figure 6.2 Special roof drains with control outlet capacity.<sup>2</sup>

## DESIGN OF STORM WATER DETENTION FACILITIES

Commonly, in new developments, detention or retention facilities are necessary for the storm water management requirements to be met. The requirements for these facilities may be relatively straightforward; for example, the objective may be to control the 10-year post-development flow to pre-development rates. Conversely, the requirements may be more complex. The facility may be required to control post-development flows to pre-development levels for a range of storms, or to control the flow rate to a predetermined level for all storm events. Detention facilities may also be used for improving water quality.

The design of the facility generally requires that the following two relationships be established:

- a. depth-versus-storage (Figure 6.4)
- b. depth-versus-discharge (Figure 6.5)

The depth versus storage relationship may be determined from the proposed grading plan of the facility and the existing topography. The depth-versus-discharge curve is dependent upon the outlet structure.

Many methods may be used for design of the proposed facility. These include both manual and computer-aided methods. For the most part, the methods used assume that the facility acts as a reservoir.

The storage indication method is widely used for routing flows through reservoirs. The following equation describes the routing process:

$$\bar{I} + \frac{S_1}{\Delta t} - \frac{O_1}{2} = \frac{S_2}{\Delta t} + \frac{O_2}{2}$$

Where  $\bar{I} = (I_1 + I_2)/2$

- $I_1, I_2$  = inflow at beginning and end of time step
- $O_1, O_2$  = outflow at beginning and end of time step
- $S_1, S_2$  = storage at beginning and end of time step
- $\Delta t$  = time step

A working curve of  $O_2$  plotted against  $(S_2/\Delta t) + (O_2/2)$  is necessary for solving the equation. An example using the storage indication method is given in "SCS National Engineering Handbook, Section 4, Hydrology."<sup>3</sup>

### Hydrograph Method

The design of underground detention facilities may be determined by knowing the inflow hydrograph and the desired release rate.

Example of Detention Pond Design:

GIVEN: An 0.4 hectare parcel of land is to be developed for commercial use. The existing land use is an undisturbed meadow. You are to design an underground detention chamber to maintain the 10-year post developed peak flow to pre-developed conditions. A 30-minute duration storm is to be used.

$$C_{\text{PRE}} = 0.3 \quad C_{\text{POST}} = 0.7$$

$$t_{c, \text{PRE}} = 10 \text{ min.} \quad t_{c, \text{POST}} = 5 \text{ min.}$$

$$I_{10} = 117 \text{ mm/hr (4.6 in./hr) for a 30-minute duration}$$

Step 1: Develop Inflow Hydrograph using Modified Rational Method

$$Q_{PRE} = CIA \times 2.78(10)^{-3} = (0.3)(117)(0.40) \times 2.78(10)^{-3} = 0.039 \text{ m}^3/\text{sec} \text{ (1.4 cfs)}$$

$$Q_{POST} = CIA \times 2.78(10)^{-3} = (0.7)(117)(0.40) \times 2.78(10)^{-3} = 0.091 \text{ m}^3/\text{sec} \text{ (3.2 cfs)}$$

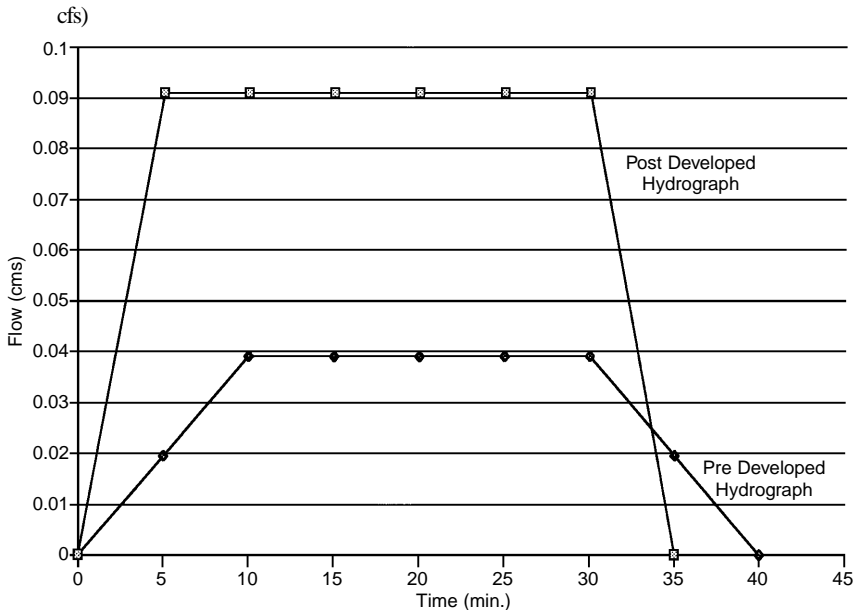


Figure 6.3 Pre and Post Hydrographs

Step 2: Estimate Required Storage Volume using the Modified Rational Method with a storm duration of 30 minutes, the storage volume is estimated as:

$$V_S = T_d Q_p - Q A T_d - Q A T_p + (Q A T_p)/2 + (Q A^2 T_p)/2 Q_p$$

where  $V_S$  = volume of storage needed

$T_d$  = duration of precipitation

$Q_p$  = peak discharge after development

$Q_A$  = peak discharge before development

$T_p$  = time to peak after development

= ratio of time to peak before development/time to peak after development

$$\begin{aligned} &= (30)(0.091) - (0.039)(30) - (0.039)(5) + \\ &\quad (2)(0.039)(5)/2 + (0.039)^2(5)/(2)(0.091) \\ &= (2.73 - 1.17 - 0.195 + 0.195 + 0.042)(60 \text{ s/min}) = 96.1 \text{ m}^3 \text{ (3330 ft}^3\text{)} \end{aligned}$$

Step 3: Size Pipe and Compute Stage-Storage Table based on the site constraints of an invert of an existing storm sewer system outfall and minimum cover requirements, a 1500 mm (5 ft) maximum pipe diameter can be used. Assuming uniform pipe size, a 54.3 m (170 ft) pipe length is required to meet the estimated storage volume. The length is increased to 60 m (200 ft). Using the dimensions of the pipe, the Stage-Storage Table can be obtained by geometric relationships. In this example, the slope of the pipe is neglected.

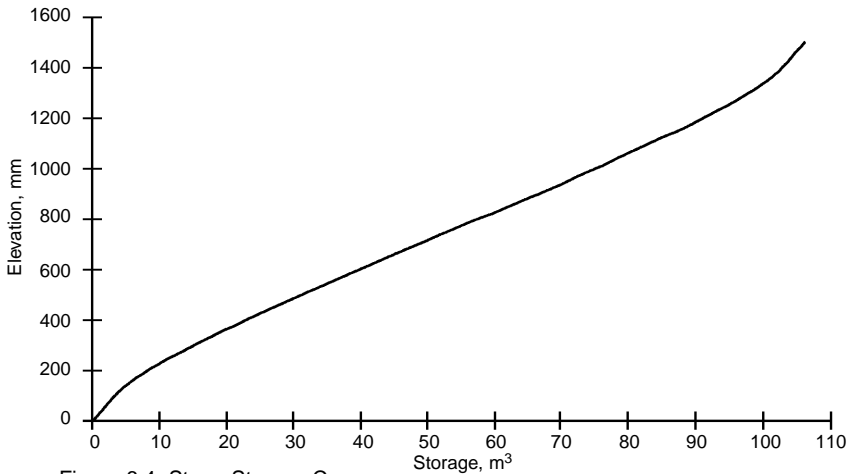


Figure 6.4 Stage-Storage Curve

**Step 4: Size Release Structure and Compute Stage Discharge Table**

An orifice will be used to regulate the discharge from the pipe. Since the maximum release rate based on pre-developed conditions is 0.039 m<sup>3</sup>/sec (1.4 cfs), an orifice is sized to release this amount at the maximum stage of approximately 1500 mm (5 ft).

Based on the orifice equation,  $Q = CdA(2gh)^{1/2}$

A 125 mm (5 in.) diameter orifice is selected and the Stage Discharge Table is computed and combined with the Stage Storage Table below. For this example,  $Cd = 0.61$ .

**Table 6.1 Stage Storage & Discharge Table**

Stage		Storage		Discharge	
mm	ft	m <sup>3</sup>	ft <sup>3</sup>	m <sup>3</sup> /s	ft <sup>3</sup> /s
0	0	0	0	0	0
150	0.5	54	205	0.010	0.3
300	1.0	15.0	559	0.016	0.6
450	1.5	27.0	991	0.021	0.7
600	2.0	39.6	1467	0.024	0.9
750	2.5	52.8	1964	0.027	1.0
900	3.0	66.6	2460	0.030	1.1
1050	3.5	79.2	2936	0.033	1.2
1200	4.0	91.2	3368	0.035	1.3
1350	4.5	100.8	3723	0.038	1.4
1500	5.0	106.2	3927	0.040	1.4

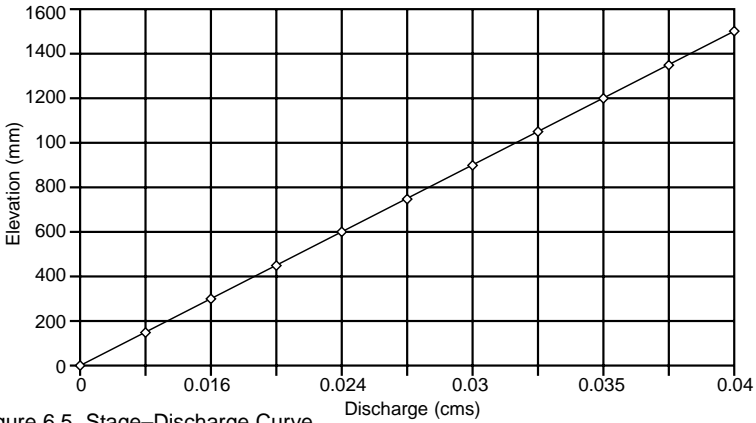


Figure 6.5 Stage-Discharge Curve

Step 5: Develop the Storage-Indicator Table and Perform the Routing from the procedures presented earlier, the following Storage-Indicator Table is developed:

Elevation		Discharge		Storage		O <sub>2</sub> /2		S <sub>2</sub> /▲t		S <sub>2</sub> /▲t + O <sub>2</sub> /2	
mm	ft	m <sup>3</sup> /s	cfs	m <sup>3</sup>	ft <sup>3</sup>						
0	0	0	0	0	0	0	0	0	0	0	0.00
150	0.5	0.010	0.3	5.4	205	0.05	0.15	0.02	0.68	0.03	0.83
300	1.0	0.016	0.6	15.0	559	0.08	0.30	0.05	1.86	0.06	2.16
450	1.5	0.021	0.7	27.0	991	0.10	0.35	0.09	3.30	0.10	3.65
600	2.0	0.024	0.9	39.6	1467	0.12	0.45	0.13	4.89	0.14	5.34
750	2.5	0.027	1.0	52.8	1964	0.18	0.50	0.18	6.55	0.19	7.05
900	3.0	0.030	1.1	66.6	2460	0.15	0.55	0.22	8.20	0.24	8.75
1050	3.5	0.033	1.2	79.2	2936	0.16	0.60	0.26	9.79	0.28	10.39
1200	4.0	0.035	1.3	91.2	3368	0.17	0.65	0.30	11.23	0.32	11.88
1350	4.5	0.038	1.4	100.8	3723	0.19	0.70	0.34	12.41	0.36	13.11
1500	5.0	0.040	1.4	106.2	3927	0.20	0.70	0.35	13.09	0.37	13.79

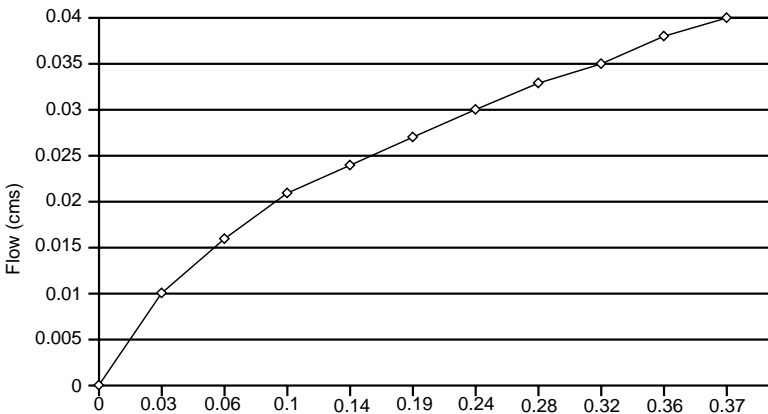


Figure 6.6 Storage Indicator Curve



Step 6: Perform the Storage Routing to obtain the Outflow Hydrograph using the procedures described earlier, compute the Storage Routing Table below:

**Table 6.3 Storage Routing Table**

Time min.	Inflow		$(I_1+I_2)/2$		$S_1/\Delta t + O_1/2$		$O_1$		$S_2/\Delta t + O_2/2$		$O_2$	
	m <sup>3</sup> /s	cfs	m <sup>3</sup> /s	cfs	m <sup>3</sup> /s	cfs	m <sup>3</sup> /s	cfs	m <sup>3</sup> /s	cfs	m <sup>3</sup> /s	cfs
0	0	0	0	0	0	0	0	0	0	0	0	0
5	.091	3.2	.046	1.60	0	0.00	0	0.00	.046	1.60	.013	0.4
10	.091	3.2	.091	3.20	.046	1.60	.013	0.40	.124	4.40	.023	0.8
15	.091	3.2	.091	3.20	.124	4.40	.023	0.80	.192	6.80	.027	1.0
20	.091	3.2	.091	3.20	.192	6.80	.027	1.00	.256	9.00	.031	1.1
25	.091	3.2	.091	3.20	.256	9.00	.031	1.10	.316	11.10	.035	1.3
30	.091	3.2	.091	3.20	.316	11.10	.035	1.30	.372	13.00	.040	1.4
35	0	0	.046	1.60	.372	13.00	.040	1.40	.378	13.20	.040	1.4
40	0	0	0	0.00	.378	13.20	.040	1.40	.338	11.80	.036	1.3
45	0	0	0	0.00	.338	11.80	.036	1.30	.302	10.50	.034	1.2
50	0	0	0	0.00	.302	10.50	.034	1.20	.268	9.30	.032	1.2
55	0	0	0	0.00	.268	9.30	.032	1.20	.236	8.10	.030	1.1
60	0	0	0	0.00	.236	8.10	.030	1.10	.206	7.00	.028	1.0
65	0	0	0	0.00	.206	7.00	.028	1.00	.178	6.00	.026	0.9
70	0	0	0	0.00	.178	6.00	.026	0.90	.152	5.10	.025	0.9
75	0	0	0	0.00	.152	5.10	.025	0.90	.127	4.20	.023	0.8
80	0	0	0	0.00	.127	4.20	.023	0.80	.104	3.40	.021	0.7
85	0	0	0	0.00	.104	3.40	.021	0.70	.083	2.70	.019	0.6
90	0	0	0	0.00	.088	2.70	.019	0.60	.064	2.10	.017	0.6
95	0	0	0	0.00	.064	2.10	.017	0.60	.047	1.50	.012	0.5
100	0	0	0	0.00	.047	1.50	.012	0.50	.035	1.00	.011	0.3
105	0	0	0	0.00	.035	1.00	.011	0.30	.024	0.70	.008	0.3
110	0	0	0	0.00	.024	0.70	.008	0.30	.016	0.40	.005	0.2
115	0	0	0	0.00	.016	0.40	.005	0.20	.011	0.20	.004	0.1
120	0	0	0	0.00	.011	0.20	.004	0.10	.007	0.10	.002	0.0
125	0	0	0	0.00	.007	0.10	.002	0.00	.005	0.10	.002	0.0

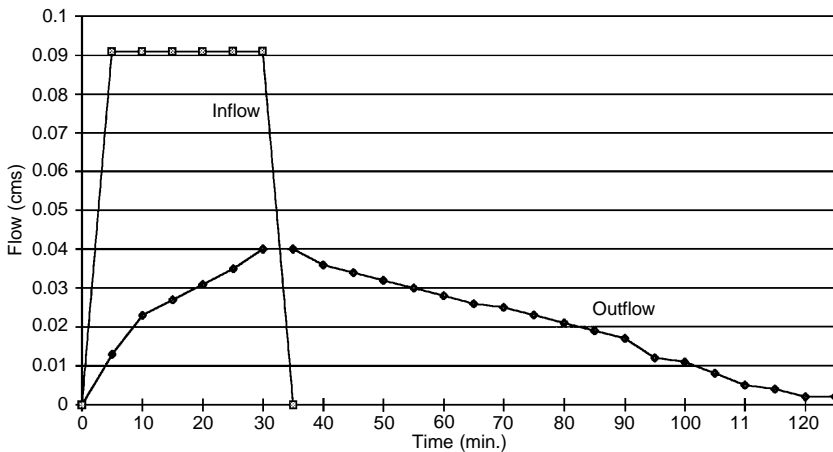


Figure 6.7 Inflow/Outflow Hydrographs

## OTHER DETENTION TECHNIQUES

### “Blue-Green” Storage

An economical way of detaining surface runoff is the “Blue-Green” approach, where the storage capacity within drainageways is utilized. This technique may be achieved by designing road crossings over drainageways to act as dams, allowing only the regulated outflow rate to be conveyed through the embankments. This technique can be repeated several times along the same drainageway, in effect creating a chain of temporary ponds. In this manner, the dynamic storage characteristics of the greenbelt system will retard the peak flows, yet provide for continuous flow in the drainageway. The culvert(s) through the embankment may be hydraulically designed to permit a range of regulated outflow rates for a series of storm events and their corresponding storage requirements. Should all the storage capacity in the drainageway be utilized, then the overflow may be permitted over the embankment. Overflow depths on minor local streets of 200–300 mm (8 to 10 in.) are usually acceptable, with lower values for roads with higher classifications. If the allowable maximum overflow depths are exceeded, then the culvert(s) through the embankment should be increased in size.

The designer must remember to design the roadway embankment as a dam, with erosion protection from the upstream point on the embankment face to below the downstream toe of the embankment.

It is also important to note that since this method is achieved through restrictions in the drainageway, backwater calculations should be performed to establish flood lines.

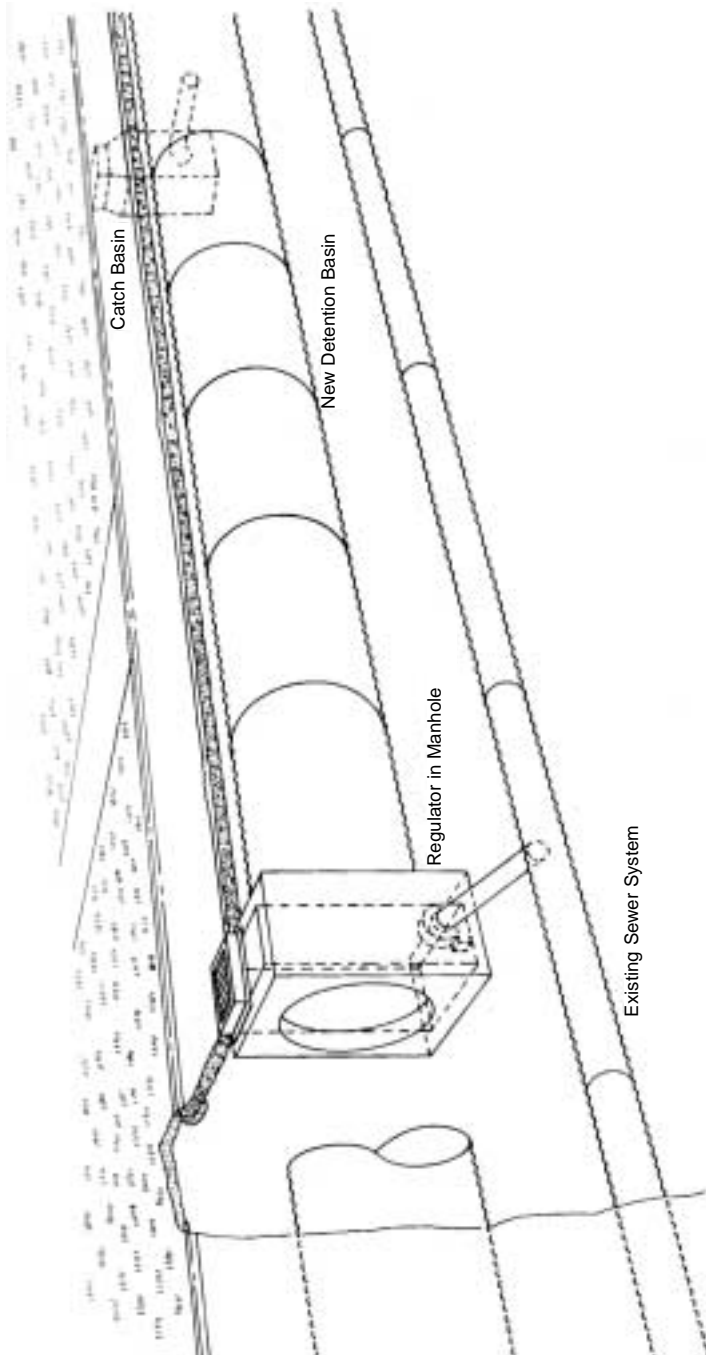
### Flow Regulators

The installation of flow regulators at inlets to storm sewers provides an effective means of preventing unacceptable storm sewer surcharging. The storm water exceeding the capacity of the storm sewer may be temporarily ponded on the road surface, or when this is not feasible, in off-line detention basins or underground tanks. Regulators may also be placed within large sewers as a means of achieving in-line system storage.

Ideally, flow regulators should be self-regulating, with minimum maintenance requirements. The simplest form of a flow regulator is an orifice with an opening sized for a given flow rate for the maximum head available. It is obviously important to avoid openings that could result in frequent clogging. For example, by placing a horizontal orifice directly under a catchbasin grating, the opening can be larger than for an orifice placed at the lower level of the outlet pipe, due to the reduction in head. Where orifice openings become too small, other forms of flow regulators designed to permit larger openings can be used. An example of such a device has been developed in Scandinavia, and has since been successfully applied in a number of installations in North America. This regulator utilizes the static head of stored water to create its own retarding energy, thus maintaining a relatively constant discharge.

It is particularly useful in existing developed areas experiencing basement flooding, such as occur with combined sewers or with separate storm sewers with foundation drains connected, as well as in areas with heavy infiltration into sanitary sewers. In such cases, all that is required is the addition of one or more storage reservoirs, each equipped with a regulator. By placing the regulator between a stor-

age reservoir and a sewer, only the pre-determined rate of flow that the sewer can handle without excessive surcharging will be released (see Figure 6.6).



**Figure 6.8** Typical installation of regulator for underground storage.

## SUBSURFACE DISPOSAL OF STORM WATER

### Introduction

Increased urbanization has resulted in extensive construction of storm drainage facilities that reduce the natural storage and infiltration characteristics of rural land. The reliance on efficient drainage systems for surface water disposal creates a series of new problems. These include; high peak flows, lowering of the water table, reduction in base flow, excessive erosion, increased flooding and pollution. Nature, through a system of bogs, swamps, forested areas, and undulating terrain, intended that the water soak back into the earth. One approach that would help emulate nature's practices is to direct storm water back into the soil.

In areas where natural well-drained soils exist, subsurface disposal of storm water may be implemented as an effective means of storm water management.

The major advantages of using subsurface disposal of storm runoff are:

- a) replenishment of groundwater reserves, especially where municipal water is dependent on groundwater sources, or where overdraft of water is causing intrusion of sea water;
- b) an economic alternative of disposing of storm runoff without the use of pumping stations, extensive outlet piping or drainage channels;
- c) an effective method of reducing runoff rates;
- d) a beneficial way to treat storm water by allowing it to percolate through the soil.

Numerous projects involving subsurface disposal of stormwater have been constructed and have been proven to be successful. However, whether runoff is being conveyed overland or discharged to underground facilities, careful consideration should be given to any adverse impact that may result. In subsurface disposal, this may include the adverse impact of percolated water on the existing quality of the groundwater.

A variety of methods are currently being employed in practice. The effectiveness and applicability of a given method should be evaluated for each location.<sup>4,5</sup> The basic methods involve the use of infiltration basins, infiltration trenches, and retention wells as discussed below.

### Infiltration Basins

Infiltration basins are depressions of varying size, either natural or excavated, into which storm water is conveyed and then permitted to infiltrate into the underlying material. Such basins may serve dual functions as both infiltration and storage facilities (see Figure 6.9). Infiltration basins may be integrated into park lands and open spaces in urban areas. In highway design they may be located in rights-of-way or in open space within freeway interchange loops.

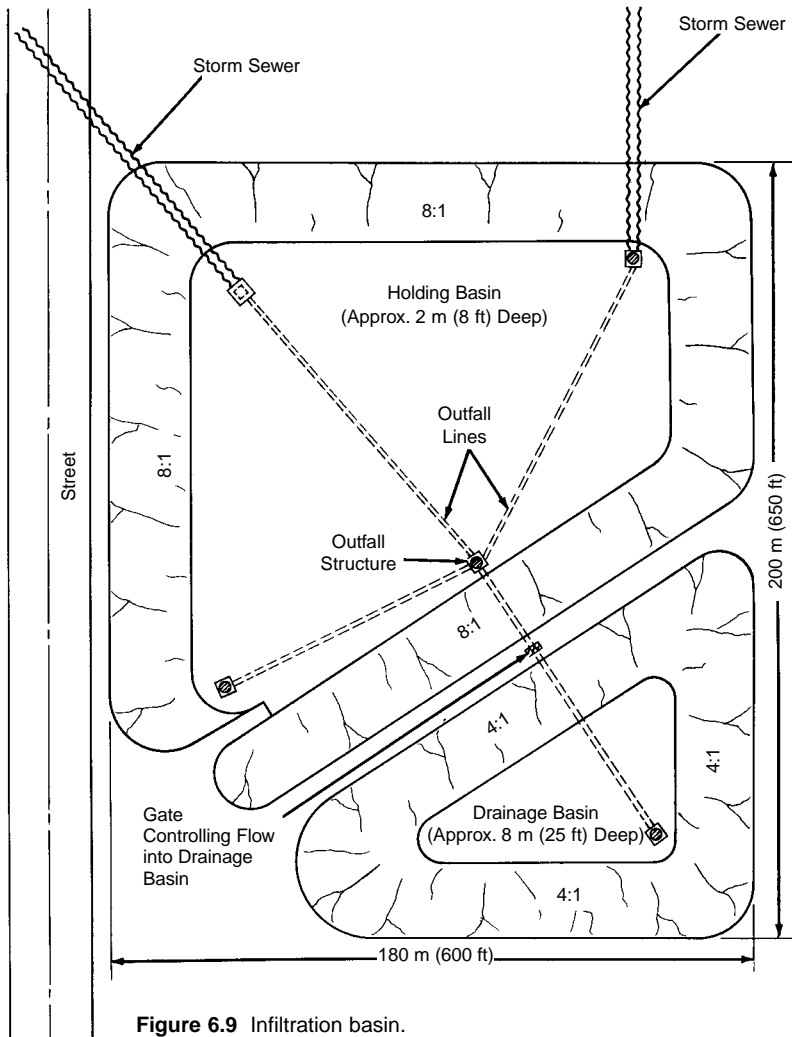
The negative aspects to basins are their susceptibility to clogging and sedimentation and the considerable surface land area required. Basins also present the problems of security of standing water and insect breeding.<sup>4</sup>

### Infiltration Trench

Infiltration trenches may be unsupported open cuts with stable side slope, or vertically-sided trenches with a concrete slab cover, void of both backfill or drainage conduits, or trenches backfilled with porous aggregate and with perforated pipes<sup>5</sup> (see Figure 6.10 a & b). The addition of the perforated pipe in the infiltra-

tion trench will distribute storm water along the entire trench length, thus providing immediate access to the trench walls. It will also allow for the collection of sediment before it can enter the aggregate backfill. Since trenches may be placed in narrow bands and in complex alignments, they are particularly suited for use in road rights-of-way, parking lots, easements, or any area with limited space. A major concern in the design and the construction of infiltration trenches is the prevention of excessive silt from entering the aggregate backfill, thus clogging the system.

The use of deep catch basins, sediment traps, filtration manholes, synthetic filter cloths, and the installation of filter bags in catch basins has proven effective.



**Figure 6.9** Infiltration basin.

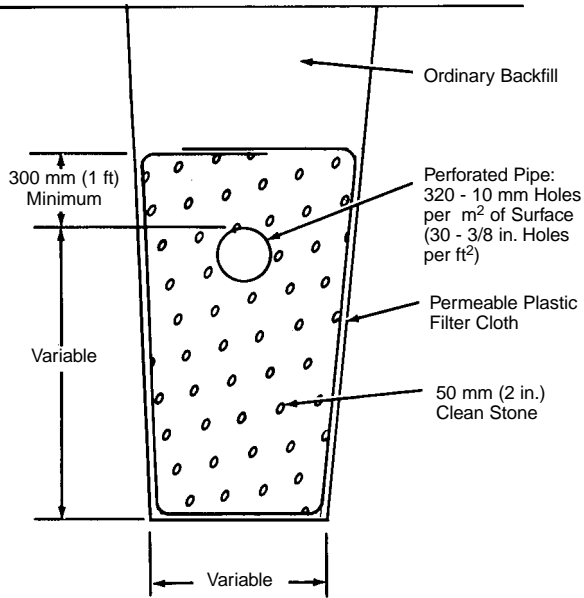


Figure 6.10a Typical trench for perforated storm sewer.

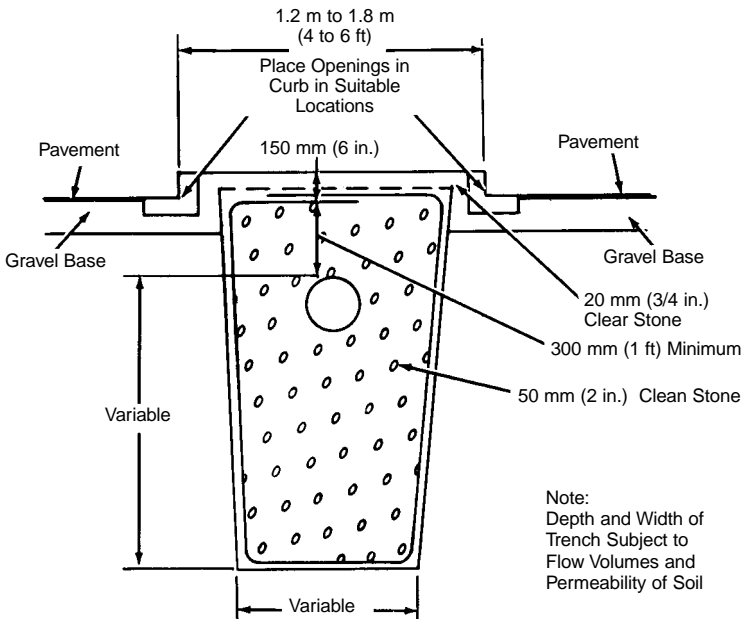


Figure 6.10b Typical trench for parking lot drainage.

### Retention Wells

The disposal of storm water directly into the subsurface may be achieved by the use of recharge wells (see Figure 6.11).

The versatility of such installations allows them to be used independently to remove standing water in areas difficult to drain, or in conjunction with infiltration basins to penetrate impermeable strata, or be employed as bottomless catch basins in conventional minor system design.

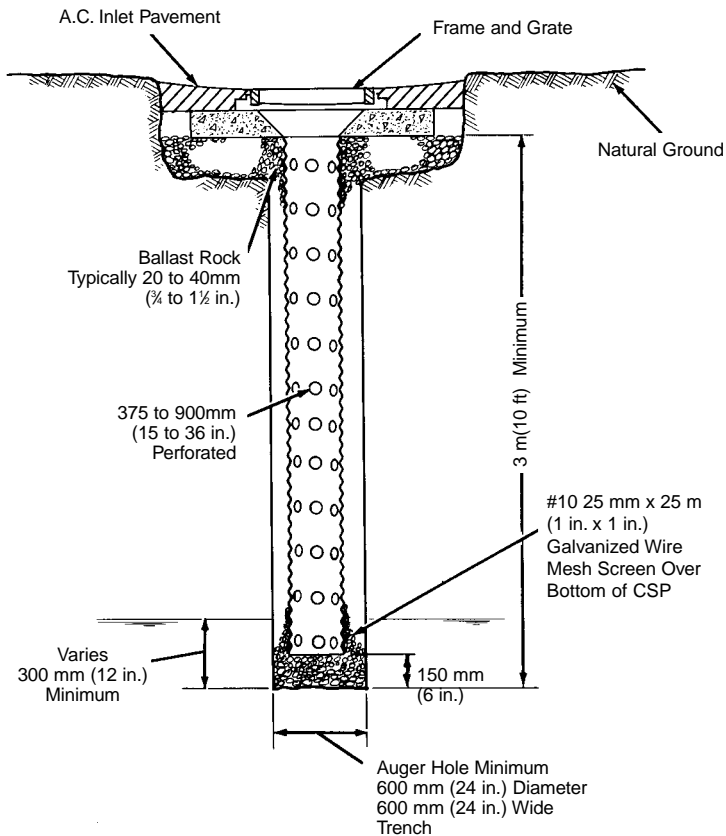


Figure 6.11 Recharge well.

## SOIL INVESTIGATION AND INFILTRATION TESTS

The rate of percolation (or infiltration) is dependent on many factors, including:

- a) type and properties of surface and subsurface soils;
- b) geological conditions;
- c) natural ground slope;
- d) location of the water table.

Several contaminants including dissolved salts, chemical substances, oil, grease, silt, clay and other suspended materials can clog surfaces reducing the infiltration rate.

The above would strongly suggest that the soil infiltration rate is best determined by carrying out field tests under known hydraulic gradients, water tables, and soil types. Laboratory tests are limited in that the condition within the laboratory may not simulate field conditions and should only be used to estimate the infiltration rate.

Field investigations should concentrate on the following:<sup>6</sup>

- a) The infiltration capability of the soil surfaces through which the water must enter the soil;
- b) The water-conducting capability of the subsoils that allow water to reach the underlying water table;



100 m (320 ft) of 3825 mm (12 ft - 5 in.) diameter structural plate pipe with gasketed seams used as an underground detention chamber collecting runoff from a shopping center near Harrisburg, PA.



- c.) The capability of the subsoils and underlying soils and geological formations to move water away from the site;
- d.) Flow from the system under mounding conditions (water table elevation = bottom of infiltration system) at the maximum infiltration rate.

### Field Tests

Field tests may be carried out using various methods, including auger holes (cased or uncased), sample trenches, pits, or well-pumping tests. The method chosen will depend on the type of facility to be designed and the site location parameters; i.e., presence of underground utilities, number of test sites required, requirements for maintenance of the vehicular and/or pedestrian traffic, type of equipment available to perform the test excavation, and type of soils. For a detailed description of alternative methods and the applicability of each, the reader is referred to a manual entitled "Underground Disposal of Storm Water Runoff," U.S. Department of Transportation.<sup>7</sup>

### Laboratory Methods

The permeability of a soil sample may be calculated by laboratory methods. Two methods commonly used are the constant head test for coarse-grained soil, and the falling head test for fine-grained soils. Other laboratory methods for determining permeability are sieve analysis and hydro-meter tests. Approximate permeabilities of different soils are listed below.<sup>8</sup>

**Table 6.4** Coefficients of permeability

Typical	Value of K mm/s (in./s)	Relative permeability
Coarse gravel	over 5 (0.2)	Very permeable
Sand, fine sand	5 – 0.05 (0.2 - $2 \times 10^{-3}$ )	Medium permeability
Silty sand, dirty sand	$0.05 - 5 \times 10^{-4}$ ( $2 \times 10^{-3} - 2 \times 10^{-7}$ )	Low permeability
Silt	$5 \times 10^{-4} - 5 \times 10^{-6}$ ( $2 \times 10^{-5} - 2 \times 10^{-5}$ )	Very low permeability
Clay	less than $5 \times 10^{-6}$ ( $2 \times 10^{-7}$ )	Practically impervious

Laboratory test specimens are mixtures of disturbed materials. The tests may therefore give permeabilities higher or lower than in situ materials. A factor of safety of 2 is commonly used to account for possible differences between laboratory and in situ values.

Darcy's law may be used to estimate the coefficient of permeability. A constant head is maintained during the laboratory test:

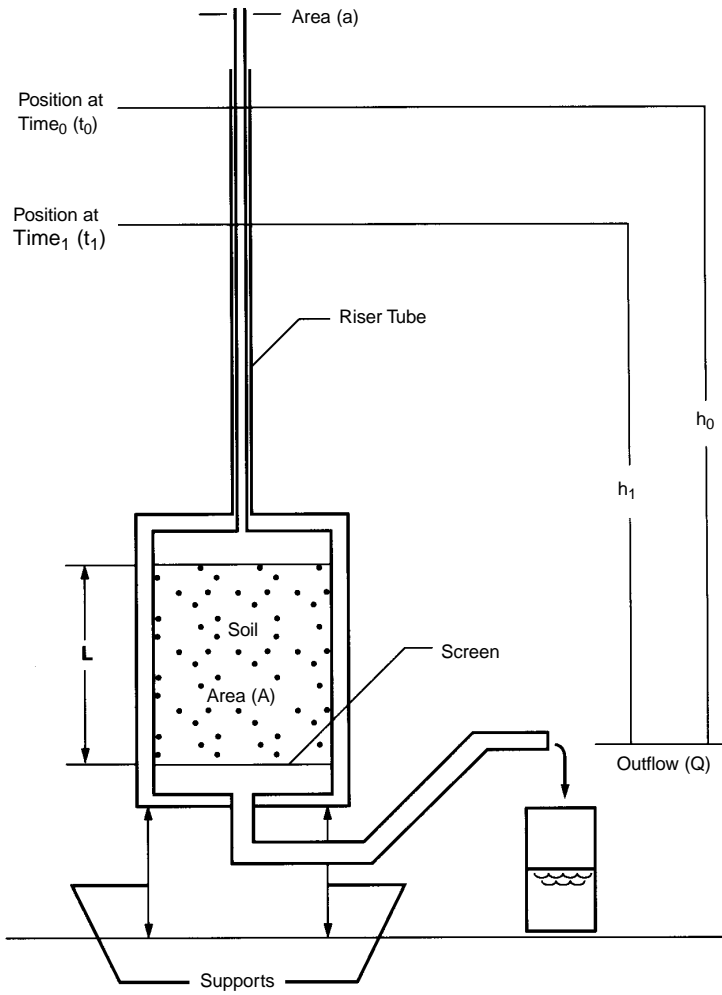
$$K = \frac{Q}{A \cdot i}$$

Where: Q = the rate of flow

A = cross sectional areas of soil through which flow takes place

K = coefficient of permeability

i = gradient or head loss over a given flow distance



**Figure 6.12** Falling head laboratory test.

In the falling head laboratory test, the head drops from the initial test point to the final test point (Figure 6.10). The following equation may be used to establish the coefficient of permeability:

$$K = \frac{2.3 a L}{A \Delta t} \log_{10} \frac{h_0}{h_1}$$

Where: A = cross sectional area of the soil through which flow takes place  
 K = coefficient of permeability  
 L = length of the soil specimen  
 a = cross sectional area of the riser tube  
 $\Delta t$  = time interval ( $t_1 - t_0$ )  
 $h_0$  = initial head  
 $h_1$  = final head

### Indirect Methods

These methods are used when field or laboratory percolation tests have not been performed.

The simplest of these methods is the use of SCS soil classification maps. Since the maps only give a general idea of the basic soil types occurring in various areas, the soil classification should be verified by field investigation. Such maps will indicate in general the expected drainage characteristics of the soil classified as good, moderate, or poor drainage. This information may aid the designer in preliminary infiltration drainage feasibility studies. Further field permeability testing should be conducted before final design.

The specific surface method of New York State<sup>9</sup> may be used to calculate the saturated coefficient of permeability from an empirical equation relating porosity, specific surface of solids, and permeability. Field permeability tests are recommended before final design.

## SUBSURFACE DISPOSAL TECHNIQUES

Subsurface disposal techniques have various applications that will result in both environmental and economic benefits. In designing any subsurface disposal system, it should be realized that for many applications the rate of runoff is considerably greater than the rate of infiltration. This fact will cause some form of detention to be required for most subsurface disposal facilities. Modifications can also be made to existing systems to take advantage of the infiltration capacity of the soil.

### Linear Recharge System

This system is similar to a conventional drainage system making use of catch basins and manholes, but storm runoff is directed to fully perforated pipes in trenches that allow for the exfiltration of the water over a larger area. Thus, the zero increase in runoff criteria may be achieved by allowing the volume of water exceeding the pre-development flows to be disposed of into the subsurface stratum. Such systems are applicable to apartment developments, parking lots, or median or ditch drainage in highway construction.

### Point Source and Recharge System

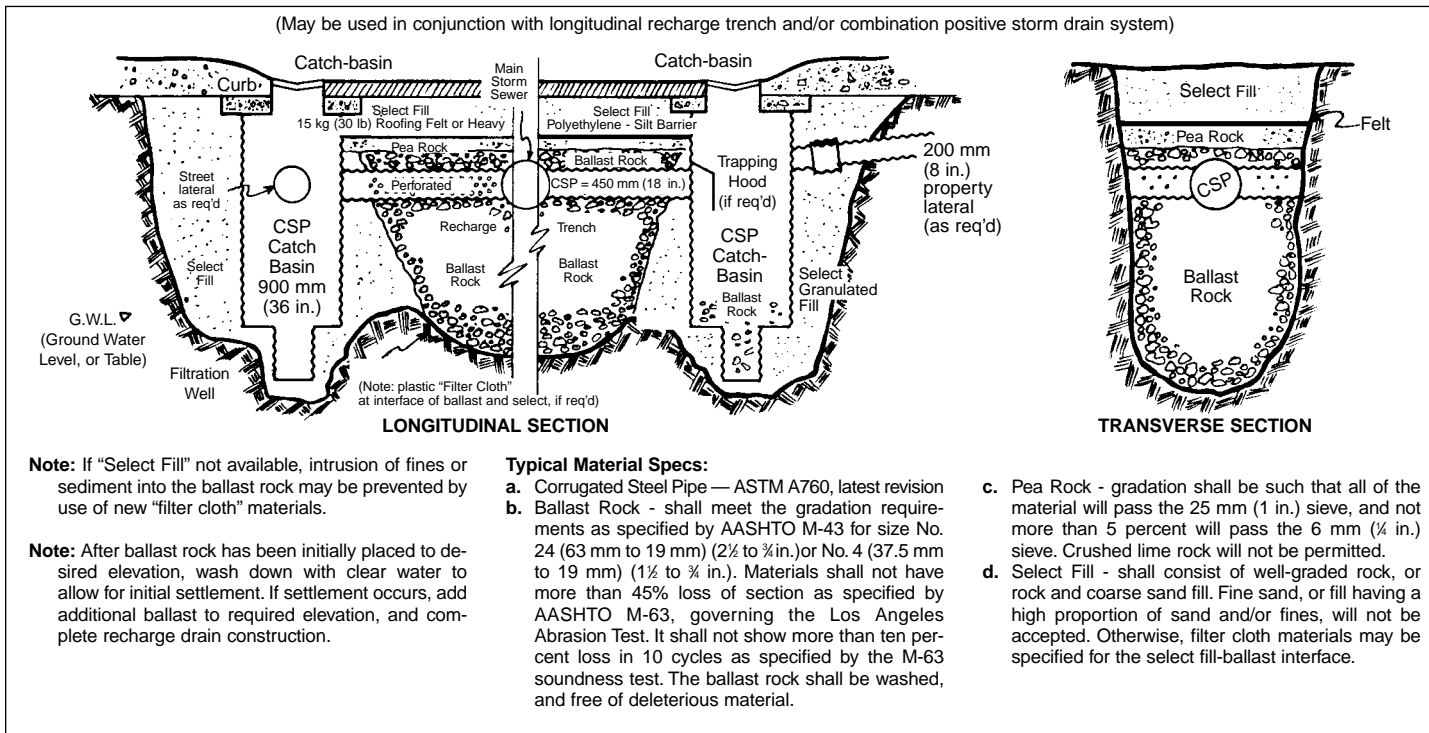
In small areas, storm runoff may be collected and disposed of in perforated catch basins or wells. Fully perforated corrugated steel pipe surrounded by a stone filter medium has been found to be very suitable in these applications. In the past, such systems were susceptible to silting up relatively quickly. The use of filter cloth surrounding the stone, and filter bags made of filter cloth placed in the catch basins, can virtually eliminate the clogging of the stone media with fines.

### Combination System

In large developments, fully perforated pipes may be used in place of conventional storm sewers, where soil conditions permit subsurface disposal. The design criteria described previously should be followed to assure that the system operates effectively. Recharge basins, fully perforated catch basins and manholes, detention areas, etc. may all be used as an effective means of stormwater management. Typical installations are shown in Figures 6.13 to 6.16.

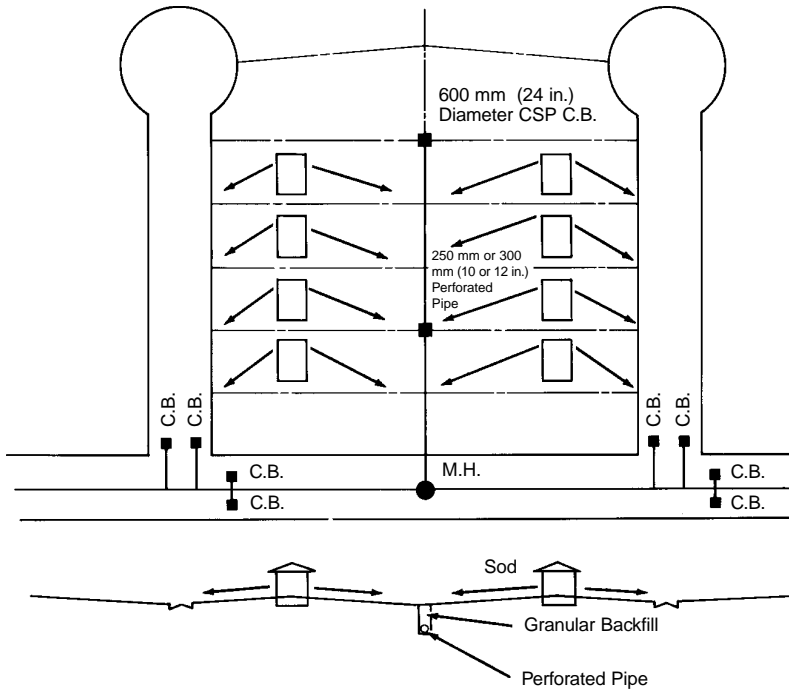


An example of a combination underground detention chamber and recharge system. Five lines of 1800 mm (72 in.) diameter corrugated steel pipe with 150 mm (6 in.) slots in the invert.



SUBSURFACE DISPOSAL OF STORMWATER RUNOFF can be an attractive alternative to present costly storm sewer conveyance systems. With the imposition of zero discharge, or zero increase of runoff regulations on land development in many urban areas, subsurface recharge may become a necessity for the drainage designer.

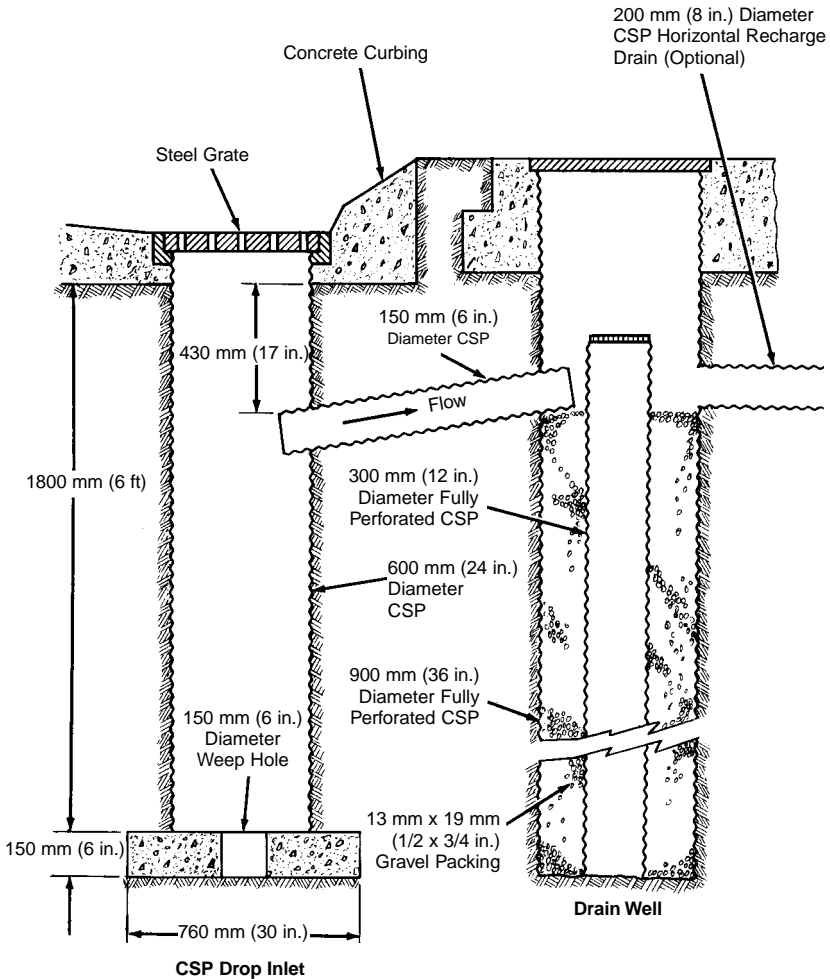
**Figure 6.13** Typical street recharge system (French Drain).



**Figure 6.14** Typical plan for “underground disposal of stormwater runoff” for residential development.



12 m (40 ft) length of 2100 mm (84 in.) fully perforated pipe banded together for installation.



**Figure 6.15** Typical design for combination catch basin for sand and sediment and recharge well. Catch basin would be periodically cleaned, and recharge well jetted through lower pipe to flush silt and restore permeability.

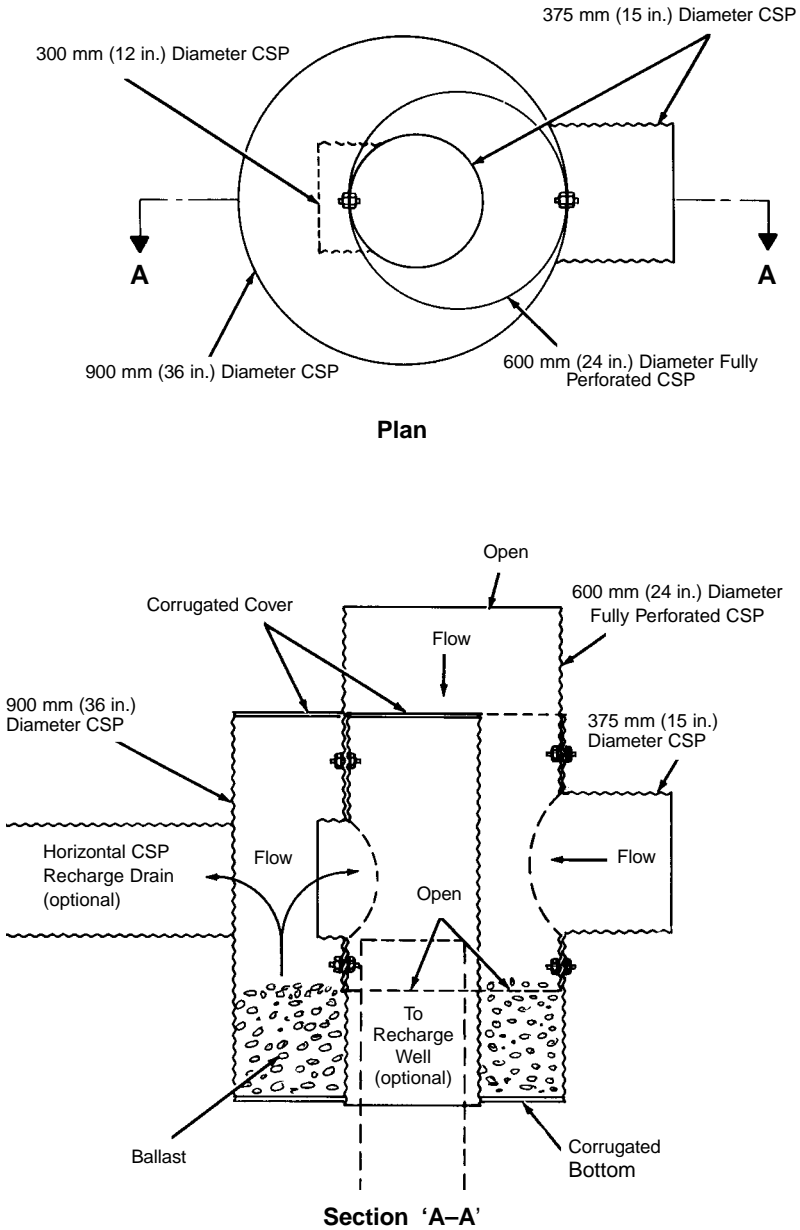


Figure 6.16 Typical CSP "Filter Manhole."



## DESIGN EXAMPLE

The main steps to be followed when designing a stormwater subsurface disposal system are summarized as follows:

- Determine “Q,” or storm runoff.
- Determine soil profile and groundwater levels.
- Determine infiltration rate.
- Design subsurface disposal systems.

The design runoff may be regulated by using the techniques discussed in Chapter 3, Hydrology.

Soil characteristics may be determined from subsurface soil investigations.

The potential infiltration rate or permeability may be estimated either from field or laboratory tests.

Several design examples for infiltration basins, infiltration trenches, and retention wells are given in “Underground Disposal of Storm Water Runoff.”<sup>11</sup> A relatively straightforward example, using an estimated coefficient of permeability, Darcy’s law, and a simplified hydrological method is given below.

An apartment development is proposed on a 0.55 ha (1.36 ac) site. The municipality requires a zero increase in runoff for a five-year storm. A combination system will be designed utilizing a regulator to discharge the pre-development outflow rate, with the excess storm being detained in an infiltration perforated pipe facility.

### Determination of Pre-Development Peak Runoff

$$\begin{aligned}
 A &= 0.55 \text{ ha (1.36 ac)} & k &= 0.00278, \text{ constant factor} \\
 T_c &= 20 \text{ minutes} \\
 I &= 69 \text{ mm/hr (2.7 in./hr) 5 year storm} \\
 C &= .2 \text{ (pre-development)} \\
 Q &= kCIA \\
 &= 0.00278 (0.2)(69)(0.55) \\
 &= 0.021 \text{ m}^3/\text{s (0.73 ft}^3/\text{s)}
 \end{aligned}$$

### Exfiltration Analysis

Soils investigations indicate a relatively pervious sub-soil, with an estimated coefficient of permeability of  $K = 6.68 \times 10^{-1} \text{ mm/s}$  ( $2.63 \times 10^{-2} \text{ in./s}$ ). It is recommended that a factor of safety of 2 be applied to this figure when calculating exfiltration.

### Exfiltration Calculations

A 900 mm (36 in.) perforated pipe surrounded by 50 mm (2 in.) clean stone will be used (Figure 6.15). The average trench surface area exposed for infiltration is  $2 \text{ m} + 2 \text{ m} = 4 \text{ m}$  ( $6.5 + 6.5 = 13.0 \text{ ft}$ ) (trench walls only considered).

Surface area of trench for exfiltration =  $4 \text{ m}^2/\text{m}$  ( $13 \text{ ft}^2/\text{ft}$ ) length

Length of trench = 12 m (40 ft)

Area of exfiltration =  $12 \text{ m} \times 4 \text{ m}^2/\text{m} = 48 \text{ m}^2$  ( $520.5 \text{ ft}^2$ )

The soil investigation has shown that the pervious subsoil extends 9 m (30 ft) from the bottom of the trench to the ground water table. The hydraulic gradient (i) may now be estimated.

$$i = \frac{h}{l}$$

where: h = average available head

l = flow distance

$$i = \frac{1.0 + 9.0}{9.0} = 1.1$$

A hydraulic gradient of 1 will be used in the design.

Exfiltration from trench:  $Q = A \cdot K \cdot i \div \text{safety factor}$ .

$$\begin{aligned} &= \frac{48 \text{ m}^2 \times 6.68 \times 10^{-4} \text{ m/s} \times 1}{2.0} \\ &= 1.61 \times 10^{-2} \text{ m}^3/\text{s} \quad (0.57 \text{ ft}^3/\text{s}) \end{aligned}$$

Time Min.	Accumulated <sup>1</sup> runoff vol. m <sup>3</sup> (ft <sup>3</sup> )	Allowable <sup>2</sup> release m <sup>3</sup> (ft <sup>3</sup> )	Exfil. <sup>3</sup> vol. m <sup>3</sup> (ft <sup>3</sup> )	Total outflow m <sup>3</sup> (ft <sup>3</sup> )	Storage requirements m <sup>3</sup> (ft <sup>3</sup> )
5	29.1 (1026)	6.3 (219)	4.8 (171)	11.1 (390)	18.0 (636)
10	46.2 (1632)	12.6 (438)	9.7 (342)	22.3 (780)	23.9 (852)
15	58.1 (2052)	18.9 (657)	14.5 (513)	33.4 (1170)	24.7 <sup>5</sup> (882)
20	66.6 (2352)	25.2 (876)	19.3 (684)	44.5 (1560)	22.1 (792)
30	81.6 (2880)	37.8 (1314)	29.0 (1026)	66.8 (2340)	14.8 (540)
40	89.7 (3168)	50.4 (1752)	38.6 (1368)	89.0 (3120)	0.7 (48)
60	105.0 (3708)	47.0 (1656)	58.0 (2052)	105.0 <sup>4</sup> (3708)	–
80	121.0 (4272)	43.7 (1536)	77.3 (2736)	121.0 (4272)	–
100	127.4 (4500)	30.8 (1080)	96.6 (3420)	127.4 (4500)	–
120	130.5 (4608)	14.6 (504)	115.9 (4104)	130.5 (4608)	–
180	149.9 (5292)	–	149.9 (5292)	149.9 (5292)	–

<sup>1</sup> Determined from mass outflow calculations using 5-year Intensity Duration Frequency Curve and post-development runoff factors.

<sup>2</sup> Rate of .021 m<sup>3</sup>/s (0.73 ft<sup>3</sup>/s) (5-year pre-development).

<sup>3</sup> Rate of 1.61 x 10<sup>-2</sup> m<sup>3</sup>/s (0.57 ft<sup>3</sup>/s) (exfiltration rate).

<sup>4</sup> Once runoff volume becomes less than allowable release plus exfiltration volume, then inflow equals outflow.

<sup>5</sup> Maximum storage required.

Storage requirement for a 5-year storm is 24.7 m<sup>3</sup> (882 ft<sup>3</sup>).

Check storage capacity of pipe and trench.

$$\text{Pipe} = \frac{40 \times \pi (3)^2}{4} = 7.63 \text{ m}^3 (283 \text{ ft}^3)$$

$$\text{Trench (43\% voids)} = (2 \times 2 \times 12 - \frac{\pi (.9)^2}{4} \times 12) \cdot .43 = 17.36 \text{ m}^3 (615 \text{ ft}^3)$$

Total Volume Available = 24.99 m<sup>3</sup> (898 ft<sup>3</sup>)  
 $\therefore$  enough storage provided for excess water

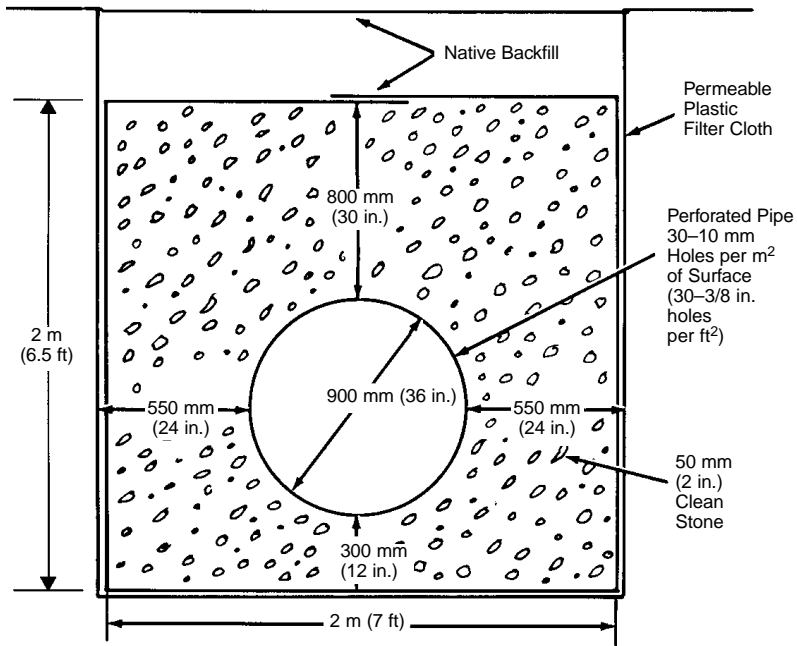


Figure 6.17 Infiltration trench cross-section.



A "Toys R Us" facility in Ocala, FL during construction showing a detention basin constructed of 18 lines of 1200 mm (48 in.) diameter fully perforated corrugated steel pipe used for a recharge system.

## CONSTRUCTION OF RECHARGE TRENCHES

Trench and ballast construction can be categorized under two soil conditions:

### **Trench in Permeable Rock and/or Stable Soil**

A recharge trench of permeable soil or rock that will support its own walls without the need for protective shoring or cages is the least difficult to construct. Unless the sidewalls are heavy in silt or fines, there is rarely a need to line the trench walls with filter cloth to deter backflow of “fines” into the ballast rock filter.

Trench depth is not critical. The recharge CSP drain should be below the frost line, but there appears to be no problem in placing the trench bottom below normal groundwater level.

A bedding of ballast rock 25–50 mm (1 to 2 in.) in size is laid prior to pipe placement, usually not less than 600 mm (2 ft) deep. The perforated pipe is placed on the bedding, and covered a minimum of 300 mm (12 in.) on sides and top, or up to the 6 mm (1/4 in.) “pea gravel” level shown in the cross-section drawing (Figure 6.11). A minimum of 150 mm (6 in.) of the 6 mm (1/4 in.) rock is laid over the ballast, and this in turn is covered with two layers of 15 kg (30 lb) construction quality felt, or two layers of construction polyethylene sheeting. This barrier is most important in preventing the vertical infiltration of silts or sediments into the ballast rock, resulting in clogging of the recharge system. The sequence is finalized with earth or base course.

The construction sequence, as shown on the following pages, is carried forward as an “assembly line” process, with the entire sequence in close proximity. It is important that care be taken not to excavate any more trench than can be completed in the working period. If too much of the trench is excavated and the walls collapse, the trench will have to be re-excavated, and the fallen wall area replaced by ballast rock. Also, any rainfall may lead to an influx of sediments into the excavated area, resulting in clogging of the pervious layers in the trench wall.

### **Trench in Non-Cohesive Soil or Sand**

Trench in non-cohesive soil or sand will result in a wider trench, and possibly the need for considerably more of the expensive ballast rock. A high percent of fines of either silt or sand may also suggest the advisability of a filter cloth between the ballast rock and native material.

A field-constructed “slip-form” of plywood can maintain the narrow width of ballast in the trench and expedite the placement of the filter cloth envelope around the ballast rock. After excavation, the plywood form is set in place, the filter cloth is loosely tacked from the top and stretched down the sides of the form.

As the sequence of bedding, pipe-laying, ballast and side fill proceeds, the tacks are pulled, and the form slowly lifted. This allows the fill to hold the rock in place instead of the form, with the filter cloth in between. The sequence is continued until the ballast rock is to desired grade. The filter cloth is then lapped over the top of the ballast rock to finish the trench.

### Perforated Pipe

Fully perforated pipes are shown on page 190. Such pipes, when used in conjunction with an infiltration trench, allow for the entire concept of subsurface disposal of storm water. Perforations of 9.5 mm (3/8 in.) diameter uniformly spaced around the full periphery of the pipe are desirable, with not less than 3.23 perforations per m<sup>2</sup> (30 per ft<sup>2</sup>). Perforations of not less than 8.0 mm (5/16 in.) may be used provided that an opening area of not less than 23,000 mm<sup>2</sup>/m<sup>2</sup> (3.31 in<sup>2</sup>/ft<sup>2</sup>) of pipe surface is achieved.



Common recharge trench installation showing relative placement of perforated pipe ballast rock, gravel, and asphalt impregnated building paper.

At manhole, junction, or other structures, the perforated pipe should be attached to a 1200 mm (4 ft) stub of unperforated pipe attached to the structure. This will prevent piping at the structure with subsequent soil settlement.



3000 mm (120 in.) diameter fully perforated pipe being fabricated on helical pipe mill.



One of two corrugated steel pipe detention chambers constructed on this industrial tract, each consisting of 730 m (2400 ft) of 1200 mm (48 in.) diameter pipe, located in Chantilly Park, VA, a few miles south of Dulles Airport.

### Synthetic Filter Fabrics

Multi-layered graded aggregate filters have been commonly used for the prevention of soil migration through the filter median. The diminishing supply of dependable aggregates and increasing prices has resulted in the increased use of synthetic filter fabrics. These fabrics are inert materials not susceptible to rot, mildew, and insect and rodent attack.

Fabric filters must provide two important functions:

1. They must prevent the migration of fines to the aggregate material.
2. They must not inhibit the free flow of water. In situations where the fabric is to act as a separator, condition 1 need only be met.

### Pipe Backfill

The aggregate material should provide sufficient void space to allow the free flow of water, and pass the fine sands, silts, silty clay and other fine material found in storm water without clogging. The void space will also provide additional storage within the trench.

## REFERENCES

1. Poertner, H. G., *Practices in Detention of Urban Storm Water Runoff*, A.P.W.A., Spec. Rep. No. 43, 1974
2. Zurn Industries Inc., Erie, Pennsylvania, U.S.A.
3. *National Engineering Handbook*, Section 4, Hydrology, U.S. Soil Conservation Service, 1964.
4. *A New Approach to Engineering and Planning for Land Developments*, Paul Theil Associates Limited, 1975.
5. *Zero Increase in Storm Water Runoff: A New Concept in Storm Water Management*, Paul Theil Associates Limited, Hudac Technical Research Committee, 1976.
6. *Recharge Basins for Disposal of Highway Storm Drainage*, Research Report 69-2, Engineering Research and Development Bureau, New York Department of Transportation, 1971.
7. *Underground Disposal of Storm Water Runoff, Design Guidelines Manual*, U.S. Department of Transportation, Federal Highway Administration, February 1980.
8. *Study on the Feasibility of Correlating Percolation Time with Laboratory Permeability*, Ministry of the Environment, Ontario, 1975
9. *Test Procedure for Specific Surface Analysis Soil Test Procedure STP-I*, Soil Mechanics Bureau, State of New York, Dept. of Transportation, No. 7.41-5-STP 1173, 1973.

## BIBLIOGRAPHY

- Wanielista, M. P., *Storm Water Management Quantity and Quality*, Ann Arbor Science Publishers Inc., 1978.
- Urban Storm Drainage*, Proceedings of International Conference, University of Southampton, Edited by P. R. Helliwell, Pontech Press Limited, 1978.
- Residential Storm Water Management*, U.L.I., A.S.C.E., N.A.H.B., 1975.



CSP sewers are designed for the deepest installations.



# Structural Design

## CHAPTER 7

### INTRODUCTION

After the pipe diameter (or pipe-arch size) has been determined for the expected hydraulic flow, the structural design must be considered. Specifically, the corrugation profile and the steel thickness must be determined so that the final installation will have strength and stiffness to adequately resist the live and dead loads present. The tables subsequently presented in this chapter simplify this process of determination. The following discussion of loadings and design considerations provides a background for the tables.

### LOADINGS

Underground conduits are subject to two principal kinds of loads:

- a) dead loads developed by the embankment of trench backfill, plus stationary superimposed surface loads, uniform or concentrated; and
- b) live loads—moving loads, including impact.

#### Live Loads

Live loads are greatest when the height of cover over the top of the pipe is small and decrease as the fill height increases. Standard highway loadings are referred to as AASHTO H-20 and H-25 live loads, and standard railroad loadings are referred to as AREA E-80 live loads. Table 7.1 gives the pressure on the pipe for H-20, H-25, and E-80 live loads.

**Table 7.1M Highway and Railway Live Loads (LL)**

Highway loading <sup>1</sup>			Railway E-80 loading <sup>1</sup>	
Depth of Cover, (m)	Load, kPa		Depth of Cover, (m)	Load, kPa
	H-20	H-25		
0.30	86.2	107.8	0.61	181.9
0.61	38.3	47.9	1.52	114.9
0.91	28.7	35.9	2.44	76.6
1.22	19.2	24.0	3.05	52.7
1.52	12.0	15.0	3.66	38.3
1.83	9.6	12.0	4.57	28.7
2.13	8.4	10.5	6.10	14.4
2.44	4.8	6.0	9.14	4.8
			>9.14	—

**Notes:** 1. Neglect live load when less than 5 kPa; use dead load only.

**Table 7.1 Highway and Railway Live Loads (LL)**

Highway loading <sup>1</sup>			Railway E-80 loading <sup>1</sup>	
Depth of Cover (feet)	Load, psf		Depth of Cover (feet)	Load, psf
	H-20	H-25		
1	1800	2280	2	3800
2	800	1150	5	2400
3	600	720	8	1600
4	400	470	10	1100
5	250	330	12	800
6	200	240	15	600
7	175	180	20	300
8	100	140	30	100
9	—	110	—	—

**Notes:** 1. Neglect live load when less than 100 psf; use dead load only.

### Dead Loads

The dead load is considered to be the soil prism over the pipe. The unit pressure of this prism acting on the horizontal plane at the top of the pipe is equal to:

$$DL = wH \dots\dots\dots(1)$$

where:  $w$  = Unit weight of soil, kN/m<sup>3</sup> (lb/ft<sup>3</sup>)

$H$  = Height of fill over pipe, m (ft)

$DL$  = Dead load pressure, kPa (lb/ft<sup>2</sup>)

### Design Pressure

When the height of cover is equal to or greater than the span or diameter of the structure, the total load (total load is the sum of the live and dead load) can be reduced by a factor of  $K$  which is a function of soil density.

For 85% Standard Density  $K = 0.86$

For 90% Standard Density  $K = 0.75$

For 95% Standard Density  $K = 0.65$

The recommended  $K$  value is for a Standard Density (AASHTO T-99 or ASTM D98) of 85%. This value easily will apply to ordinary installations in which most specifications will call for compaction of 90%. However, for more important structures in high fill situations, select a higher quality backfill at a higher density and specify the same in construction. This will extend the allowable fill height or save on thickness. If the height of cover is less than one pipe diameter, the total load (TL) is assumed to act on the pipe, and  $TL = P_v$ . In summary:

$$P_v = K (DL + LL), \text{ when } H \geq S \dots\dots\dots(2)$$

$$P_v = (DL + LL), \text{ when } H < S$$

- where:  $P_v$  = Design pressure, kPa (lb/ft<sup>2</sup>)  
 $K$  = Load factor  
 $DL$  = Dead load, kPa (lb/ft<sup>2</sup>)  
 $LL$  = Live load, kPa (lb/ft<sup>2</sup>)  
 $H$  = Height of cover, m (ft)  
 $S$  = Span, m (ft)

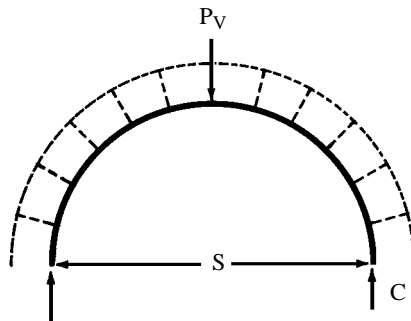
With the inherent flexibility of corrugated steel pipe, the vertically directed total load pushes the side of the pipe ring against the compacted fill material and mobilizes the passive earth pressure. Thus, the pipe ring is often assumed to be loaded by radial pressure. For round pipes, the pressure around the periphery tends to be approximately equal, particularly at deep fill heights.

For pipe-arch shapes, the pressure is approximately inversely proportional to the radius of curvature of the segments as shown in Figure 7.1. Since the pressures at the corners of the pipe-arch are greatest, the soil adjacent to them is subjected to the highest pressures. The soil in the corner areas must have sufficient bearing capacity to resist such pressure. Accordingly, the soil-bearing capacity may control the maximum allowable fill height for pipe arches.

### STRENGTH CONSIDERATIONS

The radial pressures develop a compressive thrust in the pipe wall, and the pipe must have structural strength adequate for this purpose. Accordingly, the stress in the pipe wall may be determined and compared to recognized allowable values to prevent yielding, buckling, or seam failures. Such allowable values have been derived from destructive tests done in extensive research programs, applying a safety factor of about 2.

The compressive thrust in the conduit wall is equal to the radial pressure acting on the wall multiplied by the pipe radius or  $C = P \times R$ . This thrust, called the “ring compression,” is the force carried by the steel. The ring compression is an axial force acting tangentially to the conduit wall. For conventional structures in which the top arc approaches a semicircle, it is convenient to substitute half the span for the wall radius.



Then:  $C = P_v \times \frac{S}{2}$  .....(3)  
 where:  $C$  = Ring compression, kN (lb/ft)  
 $P_v$  = Design pressure, kPa (lb/ft<sup>2</sup>)  
 $S$  = Span, m (ft)

The ultimate compressive stresses,  $f_b$ , for corrugated steel structures with back-fill compacted to 90% Standard Density and a minimum yield point of 230 MPa (33,000 lb/in<sup>2</sup>) is expressed by equations (4), (5) and (6). The first is the specified minimum yield point of the steel which represents the zone of wall crushing or yielding. The second represents the interaction zone of yielding and ring buckling. And third, the ring buckling zone.

$$f_b = f_y = 230 \text{ MPa, (33,000 lb/in.}^2) \text{ when } \frac{D}{r} \leq 294 \dots (4)$$

$$f_b = 275 - 558 \times 10^{-6} \left(\frac{D}{r}\right)^2, \text{ when } 294 < \frac{D}{r} \leq 500 \dots (5)$$

$$f_b = \frac{3.4 \times 10^7}{\left(\frac{D}{r}\right)^2},$$

or when  $\frac{D}{r} > 500$  or  $3.4 \times 10^7 \dots (6)$

$$= \frac{4.93 \times 10^9}{\left(\frac{D}{r}\right)^2},$$

- where: D = Diameter or span, mm (in.)
- r = Radius of gyration, mm (in.)
- (calculate r min. for an assumed corrugation profile from Tables 7.2.)
- I = Moment of inertia of pipe wall, mm<sup>4</sup>/m (in.<sup>4</sup>/ft)
- A = Area of pipe wall, mm<sup>2</sup>/m (in.<sup>2</sup>/ft)

A factor of safety of 2 is applied to the ultimate compressive stress to obtain the design stress,  $f_c$ .

$$f_c = \frac{f_b}{2} \dots (7)$$

The required wall area, A, is computed from the calculated compression in the pipe wall, C, and the allowable stress  $f_c$ .

$$A = \frac{C}{f_c} \dots (8)$$

Values of A and I for the various corrugations are given in Table 7.2

### HANDLING STIFFNESS

Minimum pipe stiffness requirements for practical handling and installations without undue care or bracing have been established through experience and formulated. The resultant flexibility factor, FF, limits the size of each combination of corrugation and metal thickness.

$$FF = \frac{D^2}{EI} \dots (9)$$

- where: E = Modulus of elasticity = 200 x (10)<sup>3</sup>, MPa (30 x 10<sup>6</sup> lb/in.<sup>2</sup>)
- D = Diameter or span, mm (in.)
- I = Moment of inertia of wall, mm<sup>4</sup>/mm (in.<sup>4</sup>/in.)

**Table 7.2M Moment of Inertia (I) and Cross-Sectional Area (A) of Corrugated Steel for Underground Conduits**

Corrugation Profile (mm)	Specified Thickness <sup>1</sup> , mm									
	1.32	1.63	2.01	2.77	3.51	4.27	4.79	5.54	6.32	7.11
	<b>Moment of Inertia, I, mm<sup>4</sup>/mm</b>									
38 x 6.5	5.62	7.19	9.28	14.06	19.79	26.75				
51 x 13	25.11	31.80	40.27	58.01	79.99	98.14				
68 x 13	24.58	31.00	39.20	56.13	74.28	93.82				
75 x 25	112.9	141.8	178.3	253.3	330.6	411.0				
125 x 25		145.0	181.8	256.5	332.9	411.2				
152 x 51				990.1	1281	1576	1770	2080	2395	2718
19 x 19 x 190 <sup>2</sup>		46.23	60.65	90.74	121.81					
19 x 25 x 292 <sup>2</sup>		75.05	99.63	151.7						
	<b>Cross-Sectional Wall Area, mm<sup>2</sup>/mm</b>									
38 x 6.5	1.287	1.611	2.011	2.817	3.624	4.430				
51 x 13	1.380	1.725	2.157	3.023	3.890	4.760				
68 x 13	1.310	1.640	2.049	2.870	3.692	4.515				
75 x 25	1.505	1.884	2.356	3.302	4.250	5.203				
125 x 25		1.681	2.100	2.942	3.785	4.627				
152 x 51				3.294	4.240	5.184	5.798	6.771	7.743	8.719
19 x 19 x 190 <sup>2</sup>		1.077	1.507	2.506	3.634					
19 x 25 x 292 <sup>2</sup>		0.792	1.109	1.869						

**Notes:** 1. Where two thicknesses are shown, top is corrugated steel pipe and bottom is structural plate.  
 2. Ribbed pipe. Properties are effective values.

**Table 7.2 Moment of Inertia (I) and Cross-Sectional Area (A) of Corrugated Steel for Underground Conduits**

Corrugation Profile (inches)	Specified Thickness <sup>1</sup> , inches									
	0.052	0.064	0.079	0.109	0.138	0.168	0.188	0.218	0.249	0.280
	<b>Moment of Inertia, I, in.<sup>4</sup>/ft</b>									
1 <sup>1</sup> / <sub>2</sub> x 1 <sup>1</sup> / <sub>4</sub>	.0041	.0053	.0068	.0103	.0145	0.0196				
2 x 1 <sup>1</sup> / <sub>2</sub>	.0184	.0233	.0295	.0425	.0586	0.0719				
2 <sup>2</sup> / <sub>3</sub> x 1 <sup>1</sup> / <sub>2</sub>	.0180	.0227	.0287	.0411	.0544	0.0687				
3 x 1	.0827	.1039	.1306	.1855	.2421	0.3010				
5 x 1		.1062	.1331	.1878	.2438	0.3011				
6 x 2				.725	.938	1.154	1.296	1.523	1.754	1.990
3/4 x 3/4 x 7 <sup>1</sup> / <sub>2</sub> (2)		.0431	.0569	.0858	0.1157					
3/4 x 1 x 11 <sup>1</sup> / <sub>2</sub> (2)		.0550	.0730	.1111						
	<b>Cross-Sectional Wall Area, in.<sup>2</sup>/ft</b>									
1 <sup>1</sup> / <sub>2</sub> x 1 <sup>1</sup> / <sub>4</sub>	.608	.761	.950	1.331	1.712	2.093				
2 x 1 <sup>1</sup> / <sub>2</sub>	.652	.815	1.019	1.428	1.838	2.249				
2 <sup>2</sup> / <sub>3</sub> x 1 <sup>1</sup> / <sub>2</sub>	.619	.775	.968	1.356	1.744	2.133				
3 x 1	.711	.890	1.113	1.560	2.008	2.458				
5 x 1		.794	.992	1.390	1.788	2.196				
6 x 2				1.556	2.003	2.449	2.739	3.199	3.658	4.119
3/4 x 3/4 x 7 <sup>1</sup> / <sub>2</sub> (2)		.511	.715	1.192	1.729					
3/4 x 1 x 11 <sup>1</sup> / <sub>2</sub> (2)		.374	.524	.883						

**Notes:** 1. Where two thicknesses are shown, top is corrugated steel pipe and bottom is structural plate.  
 2. Ribbed pipe. Properties are effective values.

Recommended maximum values of FF for ordinary installation:

68 x 13 mm (2½ x ½ in.) corrugation,  $FF = 0.245$  mm/N (0.043 in./lb)

125 x 25 mm (5 x 1 in.) corrugation,  $FF = 0.245$  mm/N (0.043 in./lb)

75 x 25 mm (3 x 1 in.) corrugation,  $FF = 0.245$  mm/N (0.043 in./lb)

152 x 51 mm (6 x 2 in.) corrugation,  $FF = 0.114$  mm/N (0.020 in./lb)

Increase the maximum values of FF for pipe-arch and arch shapes as follows:

Pipe-Arch  $FF = 1.5 \times FF$  shown for round pipe

Arch  $FF = 1.3 \times FF$  shown for round pipe

Higher values can be used with special care or where experience has so been proven. Trench condition, as in sewer design, is one example. Aluminum pipe experiences are another. For example, the flexibility factor permitted for aluminum pipe, in some national specifications, is more than twice that recommended above for steel. This has come about because aluminum has only one-third the stiffness of steel; the modulus for aluminum is approximately one-third the stiffness of steel; the modulus for aluminum is approximately 69 x 103 MPa (10 x 10<sup>6</sup> lb/in.<sup>2</sup>) vs. 200 x 103 MPa (30 x 10<sup>6</sup> lb/in.<sup>2</sup>) for steel. Where this degree of flexibility is acceptable in aluminum, it will be equally acceptable in steel.

Corrugation Depth		Diameter Range		Flexibility Factor	
(mm)	(in.)	(mm)	(in.)	(mm/N)	(in./lb)
6.5	¼	all		0.25	.043
13	½	1050 or less	42 or less	0.25	.043
13	½	1200 to 1800	48 to 72	0.34	.060
13	½	1950 or more	78 or more	0.46	.080
13	½	all pipe arch		0.34	.060
25	1	all		0.34	.060
51	2	all round		0.11	.019
51	2	arch & pipe arch		0.17	.029

The fill heights that follow in this chapter are for trench installations. The flexibility factors have been limited to the following values:

For spiral rib pipe, a somewhat different approach is used. To obtain better control, the flexibility factors are varied with corrugation profile, sheet thickness, and type of installation, as shown below. The details of the installation requirements are given subsequently with the allowable fill heights in Table 7.10.

Installation Type	Flexibility Factor for Ribbed Pipe, mm/N (in./lb)													
	19 x 25 x 292mm (¾ x 1 x 11½ in.)						19 x 19 x 190mm (¾ x ¾ x 7½ in.)							
	(mm/N)	(in./lb)	(mm/N)	(in./lb)	(mm/N)	(in./lb)	(mm/N)	(in./lb)	(mm/N)	(in./lb)	(mm/N)	(in./lb)		
Thickness	1.63	.064	2.01	.079	2.77	.109	1.63	.064	2.01	.079	2.77	.109	3.51	.138
II	0.13	.022	0.14	.025	0.15	.026	0.17	.022	0.19	.028	0.22	.028	0.24	.037
III	0.15	.027	0.17	.030	0.19	.033	0.21	.028	0.23	.036	0.26	.036	0.29	.043
III	0.19	.033	0.23	.040	0.25	.044	0.29	.035	0.32	.050	0.36	.050	0.40	.056

**Table 7.3 Riveted CSP—Minimum Ultimate Longitudinal Seam Strength, kN/m (lb/ft)**

Thickness		8 mm ( <sup>5</sup> / <sub>16</sub> in.) Rivets				10 mm ( <sup>3</sup> / <sub>8</sub> in.) Rivets				75 x 25 mm (3 x 1 in.)			
		68 x 13 mm (2 <sup>2</sup> / <sub>3</sub> x 1/2 in.)				68 x 13 mm (2 <sup>2</sup> / <sub>3</sub> x 1/2 in.)							
Thickness		Single		Double		Single		Double		Double		Rivet Dia.	
(mm)	(in.)	kN/m	lb/ft	(mm)	(kN/m)	(lb/ft)	(kN/m)	(lb/ft)	(kN/m)	(lb/ft)	(mm)	(in.)	
1.63	.064	244	16,700	315	—	—	—	—	419	28,700	10	<sup>3</sup> / <sub>8</sub>	
2.01	.079	266	18,200	435	—	—	—	—	521	35,700	10	<sup>3</sup> / <sub>8</sub>	
2.77	.109	—	—	—	341	23,400	683	46,800	—	—	—	—	
3.51	.138	—	—	—	357	24,500	715	49,000	929	63,700	12	<sup>7</sup> / <sub>16</sub>	
4.27	.168	—	—	—	374	25,600	748	51,300	1032	70,700	12	<sup>7</sup> / <sub>16</sub>	

- Notes:**
1. Inquire for sheet thicknesses less than 1.63mm.
  2. For 68 x 13 mm corrugation, double rivets are required for pipe diameters 1050 mm and over.

## DEFLECTION

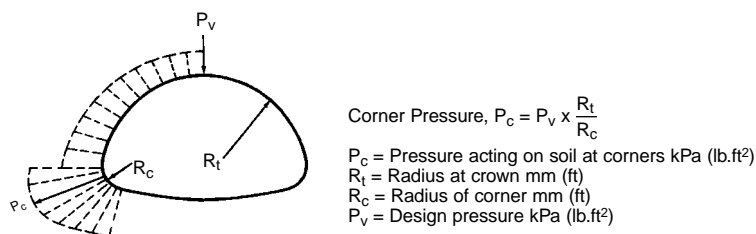
Although ring deflection does occur, it is not usually a consideration in the design of the pipe structure. It has been shown in both test and field applications that, if granular backfill soil is compacted to a specified density of 90%, the pipe deflection under total load will not influence the overall strength of the pipe.

**Table 7.4 Minimum Ultimate Longitudinal Seam Strength for SPCSP Structures, kN/m (lb/ft)**

Specified wall thickness, mm (in.)		Bolts Per Corrugation					
		2		3		4	
2.82	(0.111)	613	(42,000)	—	—		
3.56	(0.140)	905	(62,000)	—	—		
4.32	(0.170)	1182	(81,000)	—	—		
4.79	(0.188)	1357	(93,000)	—	—		
5.54	(0.218)	1634	(112,000)	—	—		
6.32	(0.249)	1926	(132,000)	—	—		
7.11	(0.280)	2101	(144,000)	2626	(180,000)	2830	(194,000)

## SEAM STRENGTH

Most pipe seams develop the full yield strength of the pipe wall. However, there are exceptions in standard pipe manufacture. Shown above in Tables 7.3 and 7.4 are those standard riveted and bolted seams that do not develop a strength equivalent to  $f_y = 230 \text{ MPa}$  (33,000 lb/in.<sup>2</sup>). To maintain a consistent factor of safety of 2 and to account for change in soil density, the maximum ring compression should not exceed the ultimate longitudinal seam strength divided by a factor of 2. Since helical lockseam and continuously-welded-seam pipe have no longitudinal seams, there is no seam strength check for these types of pipe.



**Figure 7.1.** The pressure on a pipe-arch varies with location and radius being greatest at the corners.

## PIPE-ARCHES

The pipe-arch shapes poses special design problems not found in round or vertically-elongated pipe. Pipe-arches generate corner pressures greater than the pressure in the fill. This often becomes the practical limiting design factor rather than stress in the pipe wall.

To calculate the corner pressure, ignore the bending strength of the corrugated steel and establish allowable loads based on the allowable pressure on the soil at the corners. Assuming zero moment strength of the pipe wall, ring compression,  $C$ , is the same at any point around the pipe-arch, and  $C = P \times R$  at any point on the periphery. This means the normal pressure to the pipe-arch wall is inversely proportional to the wall radius.

## ASTM STANDARD PRACTICES

A procedure for the structural design of pipe is provided by ASTM A796, "Standard Practice for Structural Design of Corrugated Steel Pipe, Pipe-Arches, and Arches for Storm and Sanitary Sewers and Other Buried Applications." The practice applies to structures installed in accordance with A798/A798M, "Standard Practice for Installing Factory-Made Corrugated Steel Pipe for Sewers and Other Applications," or A807/A807M, "Standard Practice for Installing Corrugated Steel Structural Plate Pipe for Sewers and Other Applications." These practices are frequently referenced in project specifications.

The design procedure in A796 is similar to that described in this chapter but differs in several respects. First, for the dead load, ASTM uses the weight of the entire prism of soil over the pipe and does not recognize the load reduction factor. It uses a more conservative form of the buckling equation. It provides flexibility factors for both trench and embankment conditions, some of which are more conservative than those listed here. It includes more specific information on acceptable soil types. In spite of all these differences, the resulting designs for typical projects will usually not differ greatly from those provided in this chapter.



## DESIGN EXAMPLE

The following example illustrates the application of design method used to develop the depth of cover tables.

**Given:** Pipe diameter required = 1200 mm (48 in.)  
 Depth of cover, H = 7.5 m (25 ft)  
 Live Load, LL = H-20  
 Weight of Soil, w = 19 kN/m<sup>3</sup> (120 lb/ft<sup>3</sup>)

**Find:** Wall thickness and type of corrugation.

**SOLUTION:** Assume helical pipe.

### Loadings

90% AASHTO T-99 density is specified. Assume a minimum of 85% for design.  
 $\therefore K = 0.86$

**Design Pressure,**  $P_V = 0.86 (DL + LL)$ ,  
 where DL = dead load =  $H \times 19 = 7.5 \times 19 = 143 \text{ kPa}$  (3000 lb/ft<sup>2</sup>)  
 LL = live load = negligible for cover greater than 3.0 m (8 ft) (Tables 7.1)  
 $P_V = 0.86 (142 + 0) = 123 \text{ kPa}$  (2580 lb/ft<sup>2</sup>)

**Ring Compression,**  $C = P_V \times S/2$ ,  
 where S = Span, m (ft)  
 $C = 123 \times 1.2/2 = 73.8 \text{ kN/m}$  (5160 lb/ft<sup>2</sup>)

**Design Stress,**  $f_c = f_b/2$   
 Assume 68 mm x 13 mm (2½ x ½ in.) corrugation.  
 Then,  $D/r_{\min} = 1200/4.32 = 278 < 294$   
 $f_b = f_y = 230 \text{ MPa}$  (33,000 lb/in<sup>2</sup>)  
 $f_c = f_b/2 = 115 \text{ MPa} = 115 \text{ N/mm}^2$  (16,500 lb/in<sup>2</sup>)

**Wall Area,**  $A = C/f_c = 73.8/115 = 0.636 \text{ mm}^2/\text{mm}$  (0.313 in.<sup>3</sup>/ft) required  
 From Table 7.2, a specified thickness of 1.32 mm (0.052 in.)  
 provides an uncoated wall area of 1.310 mm<sup>2</sup>/mm (0.619 in.<sup>2</sup>/ft)  
 for the 68 mm x 13mm (2½ x ½ in.) corrugation.

### Handling Stiffness

$$FF = \frac{D^2}{EI} = \text{flexibility factor} = 0.343 \text{ max (Trench installation)}$$

where: D = diameter = 1200 mm (48 in.)  
 E = modulus of elasticity =  $200 \times 10^3 \text{ MPa}$  ( $30 \times 10^6 \text{ lb/in}^2$ )  
 I = moment of inertia, mm<sup>4</sup>/mm (in.<sup>4</sup>/ft)  
 From Table 7.2, for 1.32 mm specified thickness,  
 I = 24.58 mm<sup>4</sup>/mm (0.00150 in.<sup>4</sup>/in.)

$$\text{Then } FF = \frac{1200^2}{200 \times 10^3 \times 24.58} = 0.293 \text{ (0.0512)}$$

0.293 < 0.343 (0.0512 < .060); Therefore, flexibility factor is OK.

### Selection

A specified wall thickness of 1.32 mm (0.052 in.) is selected for 68 mm x 13 mm (2½ x ½ in.) corrugated steel pipe. This selection agrees with Table 7.6.



Installing a fully paved sanitary sewer.

## DEPTH OF COVER

Tables for the selection of the steel wall thickness in millimeters, depending upon the pipe diameter and depth of cover requirements, are presented as Tables 7.5 through 7.15. Each table is for a circular pipe, pipe-arch or an arch of a particular corrugation profile. The tables include the effect of live loads (surface loads) that do not exceed an H-20, H-25 or E-80 live load, as indicated.

In addition, Tables 7.16 through 7.19 give the minimum cover requirements for round pipe under airplane wheel loads of various magnitudes. The maximum cover requirements are the same as those given for E80 live loads in Tables 7.8, 7.10, 7.11.

The tables are for trench installations, and reasonable care should be exercised in handling and installation. The pipes must be installed and the backfill must be compacted as outlined in Chapter 10, "Construction."

If other loading conditions are encountered, the designer should consult with industry sources for recommended practices.

**Table 7.5** Thickness for CSP Sewers— 38mm x 6.5mm  
(1½ x ¼ in.) Corrugation H-20, H-25, or E-80 Live Load

Diameter of Pipe		For Maximum Depth of Cover Above Top of Pipe Equal to 12m (40ft)	
		(mm)	(in.)
100	4	1.32	.052
150	6	1.32	.052
200	8	1.32	.052
250	10	1.32	.052
300	12	1.32	.052
375	15	1.32	.052
450	10	1.32	.052

- Notes:**
1. Minimum depth of cover over top of pipe is 300mm (1 ft).
  2. Backfill around pipe must be compacted to a specified AASHTO T-99 density of 90%.
  3. Use reasonable care in handling and installation.
  4. Zinc coated steel sheet thickness shown is based on commercially available sheets.

**Table 7.6 Depth of Cover for CSP Sewers—H20 or H25 Live Load  
68mm x 13mm (2<sup>2</sup>/<sub>3</sub> x 1<sup>1</sup>/<sub>2</sub> in.) Corrugation**

Diameter Of Pipe	Specified Thickness						Minimum Cover	
	mm (in.)	mm (in.)	mm (in.)	mm (in.)	mm (in.)	mm (in.)		
	1.63 .064	2.01 .079	2.77 .109	3.51 .138	4.27 .168			
Maximum Cover								
mm (in.)	m (ft)	m (ft)	m (ft)	m (ft)	m (ft)	m (ft)	(mm)	(in.)
300 12	75 246	94 308					300	12
450 18	50 164	63 207					300	12
600 24	37 121	47 154	66 216				300	12
750 30	30 98	37 121	53 174				300	12
900 36	25 82	31 102	44 144	56 184			300	12
1050 42	21 69	27 89	37 121	48 157	59 194		300	12
1200 48	18 59	23 75	33 108	42 138	52 171		300	12
1350 54	16 52	21 69	29 95	37 121	46 151		300	12
1500 60	—	18 59	26 85	34 112	41 134		300	12

- Notes:**
1. For E80 loading minimum steel thickness is 1.63 mm (.064 in).
  2. Backfill around pipe must be compacted to a specified AASHTO T-99 density of 90%.
  3. Use reasonable care in handling and installation.

**Table 7.7 Depth of Cover for CSP Pipe-Arch Sewers—68mm x 13mm  
(2<sup>2</sup>/<sub>3</sub> x 1<sup>1</sup>/<sub>2</sub> in.) Corrugation H20 or H25 Live Load**

Span x Rise		Minimum Specified Thickness Required		Maximum Depth of Cover Over Pipe-Arch for Soil Bearing Capacity of 200kPa		Minimum Cover*	
(mm)	(in.)	(mm)	(in.)	(m)	(ft)	(mm)	(in.)
430 x 330	17 x 13	1.63	.064	5.0	16	300	12
530 x 380	21 x 15	1.63	.064	4.0	15	300	12
610 x 460	24 x 18	1.63	.064	4.0	15	300	12
710 x 510	28 x 20	1.63	.064	4.0	15	300	12
885 x 610	35 x 24	1.63	.064	4.0	15	300	12
1060 x 740	42 x 29	1.63	.064	4.0	15	300	12
1240 x 840	49 x 33	2.01	.079	4.0	15	300	12
1440 x 970	57 x 38	2.77	.109	4.0	15	300	12
1620 x 1100	64 x 43	2.77	.109	4.0	15	300	12
1800 x 1200	71 x 47	3.51	.138	4.0	15	300	12
1950 x 1320	77 x 52	4.27	.168	4.0	15	300	12
2100 x 1450	83 x 57	4.27	.168	4.0	15	300	12

- Notes:**
1. Soil bearing capacity refers top the soil in the region of the pipe corners.  
The remaining backfill around the pipe-arch must be compacted to a specified AASHTO T-99 density of 90%.
  2. Use reasonable care in handling and installation.
- \* For H25 loading and 200kPa (2 tons/ft<sup>2</sup>) bearing capacity, minimum cover is 600 mm (24 in.) for all sizes.

**Table 7.8** Depth of Cover for CSP Sewers—125mm x 25mm and 75mm x 25mm (5 x 1 and 3 x 1 in.) Corrugation H20, H25 Live Load

Diameter Of Pipe		Specified Thickness										Minimum Cover	
		(mm) (in.)		(mm) (in.)		(mm) (in.)		(mm) (in.)		(mm) (in.)			
		1.63	.064	2.01	.079	2.77	.109	3.51	.138	4.27	.168		
		Maximum Cover											
(mm)	(in.)	(m)	(ft)	(m)	(ft)	(m)	(ft)	(m)	(ft)	(m)	(ft)	(mm)	(in.)
1350	54	17	56	21	69	29	95	38	125	47	154	300	12
1500	60	15	49	19	62	26	85	34	112	42	138	300	12
1650	66	14	46	17	56	24	79	31	102	38	125	30	12
1800	72	12	39	16	52	22	72	28	92	35	115	300	12
1950	78	11	36	14	46	20	64	26	85	32	105	300	12
2100	84	10	33	13	43	19	62	24	79	30	98	300	12
2250	90	10	33	12	39	17	56	23	75	28	92	300	12
2400	96	9	30	12	39	16	52	21	69	26	85	450	18
2550	102	9	30	11	36	15	49	20	66	25	82	450	18
2700	108	8	26	10	33	14	46	19	62	23	75	450	18
2850	114	8	26	10	33	13	43	17	56	21	69	450	18
3000	120			9	30	12	39	20	52	20	66	450	18
3150	126			9	30	11	36	18	49	18	59	450	18
3300	132			8	26	10	33	17	46	17	56	450	18
3450	138			8	26	10	33	16	43	16	52	450	18
3600	144					9	30	14	36	14	46	450	18

- Notes:** 1. Backfill around pipe must be compacted to a specified AASHTO T-99 density of 90%.  
2. Use reasonable care in handling and installation.

**Table 7.9** Depth of Cover for CSP Pipe-Arch Sewers— 125mm x 25mm and 75mm x 25mm (5 x 1 and 3 x 1 in.) Corrugation H20, H25 Live Load

Span x Rise		Minimum Specified Thickness Required				Minimum Cover		Maximum Depth of Cover m(ft) Over Pipe-Arch for Soil Bearing Capacities	
		75 x 25	3 x 1	125 x 25	5 x 1			200 kPa	2 tons/ft <sup>2</sup>
(mm)	(in.)	(mm)	(in.)	(mm)	(in.)	(mm)	(in.)		
1340 x 1050	53 x 41	2.01	.079	2.77	.109	300	12	7.6	25
1520 x 1170	60 x 46	2.01	.079	2.77	.109	375	15	7.6	25
1670 x 1300	66 x 51	2.01	.079	2.77	.109	375	15	7.6	25
1850 x 1400	73 x 55	2.01	.079	2.77	.109	450	18	7.3	24
2050 x 1500	81 x 59	2.01	.079	2.77	.109	450	18	6.4	21
2200 x 1620	87 x 63	2.01	.079	2.77	.109	450	18	6.1	20
2400 x 1720	95 x 67	2.01	.079	2.77	.109	450	18	6.1	20
2600 x 1820	103 x 71	2.01	.079	2.77	.109	450	18	6.1	20
2840 x 1920	112 x 75	2.01	.079	2.77	.109	525	21	6.1	20
2970 x 2020	117 x 79	2.77	.109	2.77	.109	525	21	5.8	19
3240 x 2120	128 x 83	2.77	.109	2.77	.109	600	24	5.8	19
3470 x 2220	137 x 87	2.77	.109	2.77	.109	600	24	5.8	19
3600 x 2320	142 x 91	3.51	.138	3.51	.138	600	24	5.8	19
3800 x 2440	150 x 96	3.51	.138	3.51	.138	750	30	5.8	19
3980 x 2570	157 x 101	3.51	.138	3.51	.138	750	30	5.8	19
4160 x 2670	164 x 105	3.51	.138	3.51	.138	750	30	5.8	19
4340 x 2790	171 x 110	3.51	.138	3.51	.138	750	30	5.8	19

- Notes:** 1. Soil bearing capacity refers to the soil in the region of the pipe corners. The remaining backfill around the pipe-arch must be compacted to a specified AASHTO T-99 density of 90%.  
2. Use reasonable care in handling and installation.

## INSTALLATION AND BACKFILL OF SPIRAL RIB PIPE

Satisfactory backfill material, proper placement, and compaction are key factors in obtaining satisfactory performance.

Minimum pipe metal thickness is dependent upon minimum and maximum cover and installation TYPE I, II, or III, as noted in the fill height table. Backfill in the pipe envelope shall be granular materials with little or no plasticity; free from rocks, frozen lumps, and foreign matter that could cause hard spots or that could decompose and create voids; compacted to a minimum 90% standard density per ASTM D698 (AASHTO T-99).

Installation types are:

- Type I** Installations can be in an embankment or fill condition. Installations shall meet ASTM A798 requirements. ML and CL materials are typically not recommended. Compaction equipment or methods that cause excessive deflection, distortion, or damage shall not be used.
  - Type II** Installations require trench-like conditions where compaction is obtained by hand, or walls behind equipment, or by saturation and vibration. Backfill materials are the same as for TYPE I installations. Special attention should be paid to proper lift thicknesses. Controlled moisture content and uniform gradation of the backfill may be required to limit the compaction effort while maintaining pipe shape.
  - Type III** Installations have the same requirements as TYPE II installations except that backfill materials are limited to clean, non-plastic materials that require little or no compaction effort (GP, SP), or to well graded granular materials classified as GW, SW, GM, SM, GC, or SC with a maximum plastic index (PI) of 10. Maximum loose lift thickness shall be 200 mm (8 in.). Special attention to moisture content to limit compaction effort may be required. Soil cement or cement slurries may be used in lieu of the selected granular materials.
- Note:** Simple shape monitoring-measuring the rise and span at several points in the run-is recommended as good practice with all types of installation. It provides a good check on proper backfill placement and compaction methods. Use soil placement and compaction methods that will ensure that the vertical pipe dimension (rise) does not increase in excess of 5% of the nominal diameter. Use methods that will ensure that the horizontal pipe dimension (span) does not increase in excess of 3% of the nominal diameter. These guidelines will help insure that the final deflections are within normal limits.

**Table 7.10M Depth of Cover For CSP Sewers—  
Spiral Rib Pipe H20 or H25 Live Load**

Diameter or Span (mm)	Maximum Depth of Cover Above Top of Pipe (m)						Minimum* Cover (mm)
	19 x 25 x 292 Corrugation			19 x 19 x 190 Corrugation			
	1.63 (mm)	2.01 (mm)	2.77 (mm)	1.63 (mm)	2.01(mm)	2.77(mm)	
600	15.6	22.0	36.9	15.5	21.9	36.6	300
750	12.5	17.7	29.6	12.4	17.6	29.3	300
900	10.4	14.6	24.7	10.3	14.5	24.5	300
1050	8.8	12.5	21.0	8.7	12.4	20.8	300
1200	7.9	11.0	18.6	7.8	11.0	18.4	300
1350	7.0	9.8	16.5	(6.9)	9.7	16.3	450
1500	(6.4)	8.8	14.9	[6.3]	8.7	14.8	450
1650	[5.8]	7.9	13.4		(7.8)	13.3	450
1800		(7.3)	12.2		[7.2]	12.1	450
1950		[6.7]	11.3		[6.6]	(11.2)	600
2100		[6.4]	(10.7)			(10.6)	600
2250			(9.8)			[9.7]	600
2400			[9.2]			[9.1]	600
2550			[8.8]			[8.7]	750
2700			[8.2]				750

- Notes:**
1. Allowable minimum cover is measured from top of pipe to bottom of flexible pavement or top of pipe to top of rigid pavement. Minimum cover in unpaved areas must be maintained.
  2. TYPE 1 installations are allowed unless otherwise shown.
  3. ( ) Requires TYPE II installation.
  4. [ ] Requires TYPE III installation.

**Table 7.10 Depth of Cover For CSP Sewers—  
Spiral Rib Pipe H20 or H25 Live Load**

Diameter or Span (in.)	Maximum Depth of Cover Above Top of Pipe (ft)						Minimum* Cover (in.)
	¾ x 1 x 1½ Corrugation			¾ x ¾ x 7½ Corrugation			
	0.064 (in.)	0.079 (in.)	0.109 (in.)	0.064 (in.)	0.079 (in.)	0.109 (in.)	
24	51	72	121	51	72	121	12
30	41	58	97	41	58	97	12
36	34	48	81	34	48	81	12
42	29	41	69	29	41	69	12
48	26	36	61	26	36	61	12
54	23	32	54	(23)	32	54	18
60	(21)	29	49	[21]	29	49	18
66	[19]	26	44		(26)	44	18
72		(24)	40		[24]	40	18
78		[22]	37		[22]	(37)	24
84		[21]	(35)			(35)	24
90			(32)			[32]	24
96			[30]			[30]	24
102			[29]			[29]	30
108			[27]				30

- Notes:**
1. Allowable minimum cover is measured from top of pipe to bottom of flexible pavement or top of pipe to top of rigid pavement. Minimum cover in unpaved areas must be maintained.
  2. TYPE 1 installations are allowed unless otherwise shown.
  3. ( ) Requires TYPE II installation.
  4. [ ] Requires TYPE III installation.

**Table 7.11M Depth of Cover for Structural Plate Pipe Sewers, m  
152 x 51 mm Corrugation H20 or H25 Live Load**

Diameter of Pipe (mm)	Specified Wall Thickness (mm)							Minimum Cover (mm)
	2.82	3.56	4.32	4.79	5.54	6.32	7.11	
1500	24.70	36.59	47.87	53.66	62.50	71.34	80.48	300
1655	22.56	33.54	43.60	48.48	56.71	64.94	73.17	300
1810	20.73	30.79	39.94	44.51	52.13	59.45	67.07	300
1965	18.90	28.05	36.89	41.16	47.87	54.88	61.89	300
2120	17.68	26.22	34.15	38.11	44.51	51.22	57.32	300
2275	16.46	24.39	32.01	35.67	41.77	47.56	53.66	300
2430	15.55	22.87	29.88	33.84	39.02	44.51	50.30	300
2585	14.63	21.65	28.05	31.40	36.59	41.77	47.26	300
2740	13.72	20.43	26.52	29.57	34.76	39.63	44.51	450
2895	13.11	19.21	25	28.05	32.93	37	42.38	450
3050	12.20	18.29	23.78	26.52	31.10	35.67	40.24	450
3205	11.89	17.38	22.56	25.30	29.57	34.15	38.41	450
3360	11.28	16.46	21.65	24.09	28.35	32.32	36.59	450
3515	10.67	15.85	20.73	23.17	27.13	31.10	34.76	450
3670	10.37	15.24	19.82	22.26	25.91	29.57	33.54	450
3825	9.76	14.63	19.21	21.34	25	28.35	32.32	450
3980	9.45	14.02	18.29	20.43	24.09	27.44	30.79	600
4135	9.15	13.41	17.68	19.82	23.17	26.52	29.88	600
4290	8.84	13.11	17.07	18.90	22.26	25.30	28.66	600
4445	8.54	12.5	16.46	18.29	21.34	24.39	27.74	600
4600	8.23	12.20	15.85	17.68	20.73	23.78	26.83	600
4755	7.93	11.89	15.24	17.07	20.12	22.87	25.91	600
4910	7.62	11.28	14.94	16.46	19.51	22.26	25.00	600
5065		10.98	14.33	16.16	18.90	21.65	24.39	600
5220		10.67	13.72	15.55	18.29	20.73	23.48	750
5375		10.37	13.11	14.94	17.38	19.82	22.56	750
5530		10.06	12.80	14.33	16.77	19.21	21.65	750
5685			12.20	13.72	15.85	18.30	20.73	750
5840			11.59	13.11	15.24	17.68	19.82	750
5995			11.28	12.50	14.63	16.77	18.90	750
6150			10.67	12.20	14.33	16.16	18.29	750
6305				11.59	13.72	15.55	17.38	750
6460				10.98	13.11	14.94	17.07	900
6615					12.50	14.33	16.16	900
6770					11.89	13.72	15.55	900
6925					11.59	13.11	14.94	900
7080					10.98	12.00	14.02	900
7235						12.20	13.72	1050
7390						11.58	13.11	1050
7545						10.98	12.5	1050
7700							11.89	1050
7855							11.28	1050
8010							10.67	1050

- Notes:**
1. Backfill around pipe must be compacted to a specified AASHTO T-99 density of 90%.
  2. Use reasonable care in handling and installation.
  3. Minimum covers are for H20 and H25 loads. Minimum covers are measured from top of pipe to bottom of flexible pavement or top of pipe to top of rigid pavement. Minimum cover must be maintained in unpaved traffic areas.

**Table 7.11 Depth of Cover Limits for Structural Plate Pipe, ft.  
6 x 2 in. Corrugation H20 or H25 Live Load**

Diameter or Span		Specified Wall Thickness (in.)							Minimum Cover
(ft)	(in.)	0.111	0.140	0.170	0.188	0.218	0.249	0.280	(in.)
5.0	60	81	120	157	176	205	234	264	12
5.5	66	74	110	143	159	186	213	240	12
6.0	72	68	101	131	146	171	195	220	12
6.5	78	62	92	121	135	157	180	203	12
7.0	84	58	86	112	125	146	168	188	12
7.5	90	54	80	105	117	137	156	176	12
8.0	96	51	75	98	111	128	146	165	12
8.5	102	48	71	92	103	120	137	155	18
9.0	108	45	67	87	97	114	130	146	18
9.5	114	43	63	82	92	108	123	139	18
10.0	120	40	60	78	87	102	117	132	18
10.5	126	39	57	74	83	97	112	126	18
11.0	132	37	54	71	79	93	106	120	18
11.5	138	35	52	68	76	89	102	114	18
12.0	144	34	50	65	73	85	97	110	18
12.5	150	32	48	63	70	82	93	106	24
13.0	156	31	46	60	67	79	90	101	24
13.5	162	30	44	58	65	76	87	98	24
14.0	168	29	43	56	62	73	83	94	24
14.5	174	28	41	54	60	70	80	91	24
15.0	180	27	40	52	58	68	78	88	24
15.5	186	26	39	50	56	66	75	85	24
16.0	192	25	37	49	54	64	73	82	24
16.5	198		36	47	53	62	71	80	30
17.0	204		35	45	51	60	68	77	30
17.5	210		34	43	49	57	65	74	30
18.0	216		33	42	47	55	63	71	30
18.5	222			40	45	52	60	68	30
19.0	228			38	43	50	58	65	30
19.5	234			37	41	48	55	62	30
20.0	240			35	40	47	53	60	30
20.5	246				38	45	51	57	36
21.0	252				36	43	49	56	36
21.5	258					41	47	53	36
22.0	264					39	45	51	36
22.5	270					38	43	49	36
23.0	276					36	41	46	36
23.5	282						40	45	36
24.0	288						38	43	42
24.5	294						26	41	42
25.0	300							39	42
25.5	306							37	42
26.0	312							35	42

- Notes:**
1. Backfill around pipe must be compacted to a specified AASHTO T-99 density of 90%.
  2. Use reasonable care in handling and installation.
  3. Minimum covers are for H20 and H25 loads. Minimum covers are measured from top of pipe to bottom of flexible pavement or top of pipe to top of rigid pavement. Minimum cover must be maintained in unpaved traffic areas.



**Table 7.12M Depth of Cover for Structural Plate Pipe-Arch Sewers –  
152 mm x 51 mm Corrugations, 457mm Corner Radius  
H20 and H25 Live Load**

Size		Minimum Specified Thickness Required	Minimum Cover	Maximum Cover (m) Over Pipe-Arch for the following Soil Corner Bearing Capacities		
Span (mm)	Rise (mm)			(mm)	(mm)	200 kPa (m)
1850	1400	2.82	300		5.8	
1930	1450	2.82	300		5.5	
2060	1500	2.82	300		5.2	
2130	1550	2.82	300		4.9	
2210	1600	2.82	300		4.9	
2340	1650	2.82	300		4.6	
2410	1750	2.82	450		4.3	
2490	1750	2.82	450		4.3	
2620	1800	2.82	450		4.0	
2690	1850	2.82	450		4.0	
2840	1910	2.82	450		3.7	
2900	1960	2.82	450		3.7	
2970	2010	2.82	450		3.7	
3120	2060	2.82	450		3.0	
3250	2110	2.82	450		2.7	
3330	2160	2.82	450		2.7	4.6
3480	2210	2.82	450		2.7	4.6
3530	2260	2.82	450		2.7	4.6
3610	2310	2.82	600		2.4	4.6
3760	2360	2.82	600		2.4	3.7
3810	2410	2.82	600		2.4	3.7
3860	2460	2.82	600		2.4	3.7
3910	2540	2.82	600		2.4	3.7
4090	2570	2.82	600		2.1	3.4
4240	2620	2.82	600			3.4
4290	2670	2.82	600			3.4
4340	2720	2.82	600			3.0
4520	2770	2.82	600			3.0
4720	2870	2.82	600			3.0
4780	2920	2.82	600			3.0
4830	3000	2.82	600			2.7
5000	3020	2.82	750			2.7
5050	3070	2.82	750			2.7

- Notes:**
1. Soil bearing capacity refers to the soil in the region of the pipe corners. The remaining backfill around the pipe-arch must be compacted to a specific AASHTO T-99 density of 90%.
  2. Use reasonable care in handling and installation.
  3. Minimum covers are for H20 and H25 loads. Minimum covers are measured from top of pipe to bottom of flexible pavement or top of pipe to top of rigid pavement. Minimum cover must be maintained in unpaved traffic areas.

**Table 7.12 Depth of Cover for Structural Plate Pipe-Arch Sewers –  
6 x 2 in. Corrugations, 18 in. Rc Corner Radius  
H20 or H25 Live Load**

Size		Minimum Specified Thickness Required (in.)	Minimum* Cover (in.)	Maximum Cover (ft) Over Pipe-Arch for the Following Soil Corner Bearing Capacities	
Span (ft-in.)	Rise (ft-in.)			2 tons/ft <sup>2</sup>	3 tons/ft <sup>2</sup>
6-1	4-7	0.111	12	19	
6-4	4-9	0.111	12	18	
6-9	4-11	0.111	12	17	
7-0	5-1	0.111	12	16	
7-3	5-3	0.111	12	16	
7-8	5-5	0.111	12	15	
7-11	5-7	0.111	12	14	
8-2	5-9	0.111	18	14	
8-7	5-11	0.111	18	13	
8-10	6-1	0.111	18	13	
9-4	6-3	0.111	18	12	
9-6	6-5	0.111	18	12	
9-9	6-7	0.111	18	12	
10-3	6-9	0.111	18	12	
10-8	6-11	0.111	18	10	
10-11	7-1	0.111	18	8	
11-5	7-3	0.111	18	8	15
11-7	7-5	0.111	18	8	15
11-10	7-7	0.111	18	7	14
12-4	7-9	0.111	24	6	12
12-6	7-11	0.111	24	6	12
12-8	8-1	0.111	24	6	11
12-10	8-4	0.111	24	6	11
13-5	8-5	0.111	24	5	11
13-11	8-7	0.111	24	5	10
14-1	8-9	0.111	24	5	10
14-3	8-11	0.111	24	5	10
14-10	9-1	0.111	24	5	10
15-4	9-3	0.111	24		9
15-6	9-5	0.111	24		9
15-8	9-7	0.111	24		9
15-10	9-10	0.111	24		9
16-5	9-11	0.111	30		9
16-7	10-1	0.111	30		9

- Notes:**
1. Soil bearing capacity refers to the soil in the region of the pipe corners. The remaining backfill around the pipe-arch must be compacted to a specific AASHTO T-99 density of 90%.
  2. Use reasonable care in handling and installation.
  3. Minimum covers are for H20 and H25 loads. Minimum covers are measured from top of pipe to bottom of flexible pavement or top of pipe to top of rigid pavement. Minimum cover must be maintained in unpaved traffic areas.

**Table 7.13M Depth of Cover for Structural Plate Pipe-Arch Sewers – 152mm x 51mm corrugations, 787mm Corner Radius H20 and H25 Live Load**

Size		Minimum Specified Thickness Required (mm)	Minimum Cover (mm)	Maximum Depth of Cover (m) Over Pipe-Arch for Soil Bearing Capacities (kPa)	
Span (mm)	Rise (mm)			200	300
4040	2840	2.82	600	4.0	
4110	2900	2.82	600	4.0	
4270	2950	2.82	600	3.7	
4320	3000	2.82	600	3.7	
4390	3050	2.82	600	3.7	
4550	3100	2.82	600	3.7	
4670	3150	2.82	600	3.4	
4750	3200	2.82	600	3.4	
4830	3250	2.82	750	3.4	
4950	3300	2.82	750	3.0	
5030	3350	2.82	750	3.0	
5180	3400	2.82	750	3.0	4.6
5230	3450	2.82	750	3.0	4.6
5310	3510	2.82	750	3.0	4.6
5460	3560	2.82	750	3.0	4.3
5510	3610	2.82	750	2.7	4.3
5660	3660	2.82	750	2.7	4.3
5720	3710	2.82	750	2.7	4.3
5870	3760	2.82	750	2.7	4.0
5940	3810	3.56	750	2.7	4.0
5990	3860	3.56	750	2.7	4.0
6070	3910	3.56	750	2.7	4.0
6220	3960	3.56	900	2.4	4.0
6270	4010	3.56	900	2.4	4.0

- Notes:**
1. Soil bearing capacity refers to the soil in the region of the pipe corners. The remaining backfill around the pipe-arch must be compacted to a specific AASHTO T-99 density of 90%.
  2. Use reasonable care in handling and installation.
  3. Minimum covers are for H20 and H25 loads. Minimum covers are measured from top of pipe to bottom of flexible pavement or top of pipe to top of rigid pavement. Minimum cover must be maintained in unpaved traffic areas.

**Table 7.13 Depth of Cover for Structural Plate Pipe-Arch Sewers –  
152mm x 51mm Corrugations, 787mm Corner Radius  
H20 and H25 Live Load**

Size		Minimum Specified Thickness Required (in.)	Minimum Cover (in.)	Maximum Depth of Cover (ft) Over Pipe-Arch for Soil Bearing Capacities	
Span (ft-in.)	Rise (ft-in.)			2 tons/ft <sup>2</sup>	3 tons/ft <sup>2</sup>
13-3	9-4	0.111	24	13	
13-6	9-6	0.111	24	13	
14-0	9-8	0.111	24	12	
14-2	9-10	0.111	24	12	
14-5	10-0	0.111	24	12	
14-11	10-2	0.111	24	12	
15-4	10-4	0.111	24	11	
15-7	10-6	0.111	24	11	
15-10	10-8	0.111	24	10	
16-3	10-10	0.111	30	10	
16-6	11-0	0.111	30	10	
17-0	11-2	0.111	30	10	15
17-2	11-4	0.111	30	10	15
17-5	11-6	0.111	30	10	15
17-11	11-8	0.111	30	10	14
18-1	11-10	0.111	30	9	14
18-7	12-0	0.111	30	9	14
18-9	12-2	0.111	30	9	14
19-3	12-4	0.111	30	9	13
19-6	12-6	0.140	30	9	13
19-8	12-8	0.140	30	9	13
19-11	12-10	0.140	30	9	13
20-5	13-0	0.140	36	8	13
20-7	13-2	0.140	36	8	13

- Notes:**
1. Soil bearing capacity refers to the soil in the region of the pipe corners. The remaining backfill around the pipe-arch must be compacted to a specific AASHTO T-99 density of 90%.
  2. Use reasonable care in handling and installation.
  3. Minimum covers are for H20 and H25 loads. Minimum covers are measured from top of pipe to bottom of flexible pavement or top of pipe to top of rigid pavement. Minimum cover must be maintained in unpaved traffic areas.

**Table 7.14M Minimum Cover in Feet for Airplane Wheel Loads on Flexible Pavements—68mm x 13mm Corrugation**

<b>Case 1. Loads to 178 kN – Dual Wheels</b>									
Wall Thickness (mm)	Pipe Diameter (mm)								
	300	450	600	900	1200	1500	1800	2100	2400
1.63	300	300	300	450	600				
2.01	300	300	300	450	600				
2.77			300	300	450	600			
3.51				300	450	450	600		
4.27				300	300	450	450	600	600
<b>Case 2. Loads to 489 kN – Dual Wheels</b>									
1.63	450	450	450	600	750				
2.01	450	450	450	600	750				
2.77			450	450	600	750			
3.51				450	600	600	750		
4.27				450	450	600	750	750	750
<b>Case 3. Loads to 3336 kN – Dual-Dual</b>									
1.63	600	600	600	750	900				
2.01	600	600	600	600	750				
2.77			600	600	750	750			
3.51				600	600	750	900		
4.27				600	600	600	750	900	900
<b>Case 4. Loads to 6672 kN</b>									
1.63	750	750	750	750	900				
2.01	750	750	750	750	750				
2.77			750	750	750	750			
3.51				750	750	750	900		
4.27				750	750	750	750	900	900
Diam.	300	450	600	900	1200	1500	1800	2100	2400

- Notes:**
1. Backfill around pipe must be compacted to a specified AASHTO T-99 density of 90%.
  2. Use reasonable care in handling and installation.
  3. Minimum cover is from top surface of flexible pavement to top of CSP.
  4. Loads are total load of airplane.
  5. Seam strength must be checked for riveted pipe.
- \* From Airport Drainage, U.S. Dept. of Transportation, F.A.A., 1990.

**Table 7.14 Minimum Cover in Feet for Airplane Wheel Loads on Flexible Pavements— $2\frac{2}{3} \times \frac{1}{2}$  in. Corrugation**

<b>Case 1. Loads to 40,000 Lb. – Dual Wheels</b>									
Specified Thickness (in.)	Pipe Diameter (in.)								
	12	18	24	26	48	60	72	84	96
.064	1.0	1.0	1.0	1.5	2.0				
.079	1.0	1.0	1.0	1.5	2.0				
.109			1.0	1.0	1.5	2.0			
.138				1.0	1.5	1.5	2.0		
.168				1.0	1.0	1.5	1.5	2.0	2.0
<b>Case 2. Loads to 110,000 Lb. – Dual Wheels</b>									
.064	1.5	1.5	1.5	2.0	2.5				
.079	1.5	1.5	1.5	2.0	2.5				
.109			1.5	1.5	2.0	2.5			
.138				1.5	2.0	2.0	2.5		
.168				1.5	1.5	2.0	2.5	2.5	2.5
<b>Case 3. Loads to 750,000 Lb. – Dual-Dual</b>									
.064	2.0	2.0	2.0	2.5	3.0				
0.79	2.0	2.0	2.0	2.0	2.5				
.109			2.0	2.0	2.5	2.5			
.138				2.0	2.0	2.5	3.0		
.168				2.0	2.0	2.0	2.5	3.0	3.0
<b>Case 4. Loads to 1.5 Million Lb.</b>									
.064	2.5	2.5	2.5	2.5	3.0				
.079	2.5	2.5	2.5	2.5	2.5				
.109			2.5	2.5	2.5	2.5			
.138				2.5	2.5	2.5	3.0		
.168				2.5	2.5	2.5	2.5	3.0	3.0
Diam.	12	18	24	36	48	60	72	84	96

- Notes:**
1. Backfill around pipe must be compacted to a specified AASHTO T-99 density of 90%.
  2. Use reasonable care in handling and installation.
  3. Minimum cover is from top surface of flexible pavement to top of CSP.
  4. Loads are total load of airplane.
  5. Seam strength must be checked for riveted pipe.
- \* From Airport Drainage, U.S. Dept. of Transportation, F.A.A., 1990.

**Table 7.15M Minimum Cover in Feet for Airplane Wheel Loads on Flexible Pavements\*— 125mm x 25mm and 75mm x 25mm Corrugation**

<b>Case 1. Loads to 178 kN – Dual Wheels</b>								
Wall Thickness (mm)	Pipe Diameter (mm)							
	900	1200	1500	1800	2100	2400	2700	3000
1.63	450	450	450	600	600	750		
2.01	450	450	450	600	600	750		
2.77	300	300	450	450	450	600	600	600
3.51	300	300	300	450	450	450	600	600
4.27	300	300	300	450	450	450	450	600
<b>Case 2. Loads to 489 kN – Dual Wheels</b>								
1.63	450	600	600	750	750	900		
2.01	450	450	600	750	750	750	900	
2.77	450	450	600	600	750	750	750	900
3.51	450	450	450	600	600	750	750	750
4.27	450	450	450	450	600	600	750	750
<b>Case 3. Loads to 3336 kN – Dual-Dual</b>								
1.63	600	600	750	750	900	1050		
2.01	600	600	750	750	900	900	1050	
2.77	600	600	600	750	750	900	900	900
3.51	600	600	600	600	750	750	750	900
4.27	600	600	600	600	600	750	750	750
<b>Case 4. Loads to 6672 kN</b>								
1.63	750	750	750	900	900	1050		
2.01	750	750	750	750	900	900	1050	
2.77	750	750	750	750	750	900	900	1050
3.51	750	750	750	750	750	750	900	900
4.27	750	750	750	750	750	750	750	900
Diam.	900	1200	1500	1800	2100	2400	2700	3000

- Notes:**
1. Backfill around pipe must be compacted to a specified AASHTO T-99 density of 90%.
  2. Use reasonable care in handling and installation.
  3. Minimum cover is from top surface of flexible pavement to top of CSP.
  4. Loads are total load of airplane.
  5. Seam strength must be checked for riveted pipe.

\* From Airport Drainage, U.S. Dept. of Transportation, F.A.A., 1990.

**Table 7.15 Minimum Cover in Feet for Airplane Wheel Loads on Flexible Pavements\*— 5 x 1 in. and 3 x 1 in. Corrugation**

<b>Case 1. Loads to 40,000 Lb. – Dual Wheels</b>								
Specified Thickness (in.)	Pipe Diameter (in.)							
	36	48	60	72	84	96	108	120
.064	1.0	1.5	1.5	2.0	2.0	2.5		
.079	1.5	1.5	1.5	2.0	2.0	2.5		
.109	1.0	1.0	1.5	1.5	1.5	2.0	2.0	2.0
.138	1.0	1.0	1.0	1.5	1.5	1.5	2.0	2.0
.168	1.0	1.0	1.0	1.5	1.5	1.5	1.5	2.0
<b>Case 2. Loads to 110,000 Lb. – Dual Wheels</b>								
.064	1.5	2.0	2.0	2.5	2.5	3.0		
.079	1.5	1.5	2.0	2.5	2.5	2.5	3.0	
.109	1.5	1.5	2.0	2.0	2.5	2.5	2.5	3.0
.138	1.5	1.5	1.5	2.0	2.0	2.5	2.5	2.5
.168	1.5	1.5	1.5	1.5	2.0	2.0	2.5	2.5
<b>Case 3. Loads to 750,000 Lb. – Dual-Dual</b>								
.064	2.0	2.0	2.5	2.5	3.0	3.5		
.079	2.0	2.0	2.5	2.5	3.0	3.0	3.5	
.109	2.0	2.0	2.0	2.5	2.5	3.0	3.0	3.0
.138	2.0	2.0	2.0	2.0	2.5	2.5	2.5	3.0
.168	2.0	2.0	2.0	2.0	2.0	2.5	2.5	2.5
<b>Case 4. Loads to 1.5 Million Lb.</b>								
.064	2.5	2.5	2.5	3.0	3.0	3.5		
.079	2.5	2.5	2.5	2.5	3.0	3.0	3.5	
.109	2.5	2.5	2.5	2.5	2.5	3.0	3.0	3.5
.138	2.5	2.5	2.5	2.5	2.5	2.5	3.0	3.0
.168	2.5	2.5	2.5	2.5	2.5	2.5	2.5	3.0
Diam.	36	48	60	72	84	96	108	120

- Notes:**
1. Backfill around pipe must be compacted to a specified AASHTO T-99 density of 90%.
  2. Use reasonable care in handling and installation.
  3. Minimum cover is from top surface of flexible pavement to top of CSP.
  4. Loads are total load of airplane.
  5. Seam strength must be checked for riveted pipe.
- \* From Airport Drainage, U.S. Dept. of Transportation, F.A.A., 1990.



**Table 7.16 Minimum Cover for Airplane Wheel Loads on Rigid Pavements\* (All Corrugations)**

Pipe Diameter		Single Wheel		Single Wheel		Twin Assembly		Twin Assembly	
(mm)	(in.)	67 kN	15,000lb	111kN	25,000lb	445 kN	100,000lb	1179 kN	265,000lb
150 – 1500	6-60	150	0.5	150	0.5	300	1.0	300	1.01
1650 – 2700	66-108	300	1.0	300	1.0	450	1.5	450	1.5

- Notes:**
1. See Table 7.6, 7.8, or 7.11 for maximum depth of cover.
  2. Backfill around pipe must be compacted to a specified AASHTO T-99 density of 90%.
  3. Use reasonable care in handling and installation.
  4. Minimum cover is from bottom of slab to top of pipe.
  5. Loads are not total loads but loads per wheel or assembly.
  6. Minimum cover for C5A airplane is same as 445 kN assembly.
- \* From "Development of Minimum Pipe-Cover Requirements for C5A and Other Aircraft Loadings" C.C. Calhoun, Jr. and H.H. Ulery, Jr., U.S. Army WES, Vicksburg, MS, Paper S-73-65, November 1973.

**Table 7.17 Minimum Cover Airplane Wheel Loads on Flexible Pavements – 152 x 152 mm (6 x 2 in.) Corrugation**

Dual Wheels With Loads To	178 kN (40,000 lb)	489 kN (110,000 lb)	3336 kN (750,000 lb)	6672 kN (1.5 million lb)
Minimum Cover	D/8 but not less than 300 mm (1.0 ft)	D/6 but not less than 450 mm (1.5 ft)	D/5 but not less than 600 mm (2.0 ft)	D/4 but not less than 750 mm (2.5 ft)

- Notes:**
1. See Table 7.11 for maximum depth of cover.
  2. Backfill around pipe must be compacted to a specified AASHTO T-99 density of 90%.
  3. Use reasonable care in handling and installation.
  4. Minimum cover is from top surface of flexible pavement to top of CSP.
  5. Loads are total of airplane.

## Aerial Sewers

Should the need arise to run sewers above ground to cross ravines or streams, CSP aerial sewers supported on bents afford an economical solution. Table 7.19 provides a table of allowable spans for this purpose. The table provides for pipes flowing full of water, including the weight of an asphalt-coated pipe. The bending moments were calculated on the basis of a simple span and limited to a factored value of ultimate bending moment. Ultimate moments were determined theoretically and verified by limited testing.

Consideration must be given to the design of the pipe support system. Small diameter pipe with short spans can often be placed directly on bents. Larger diameter pipe should be supported in shaped 120 degree concrete cradles or by a ring girder. The severity of the support requirements increases with diameter and span. Design methods used for smooth steel water pipe systems can be adapted to investigate these requirements.

## Design of Fittings

Corrugated steel pipe is available with an almost unlimited assortment of factory supplied fittings. However special structural considerations are appropriate to prevent loss of ring strength when designing fittings for branch connections. It may be necessary to reinforce the opening. This is particularly true for larger diameter pipe, and for branches at acute angles and in wye branches. A new ASTM design specification has been developed and a Design Data Sheet is available from NCSA.



CSP aerial sewer being installed.

**Table 7.18M Allowable Span (m) for CSP Flowing Full**

Diameter of Pipe (mm)	Specified Steel Thickness* (mm)								
	1.63	2.01	2.77	3.51	4.27	4.79	5.54	6.32	7.11
<b>68mm x 13mm Corrugation</b>									
600	4.0	4.6	6.1	–	–	–	–	–	–
900	3.7	4.6	6.1	7.6	–	–	–	–	–
1200	3.4	4.3	5.8	7.6	9.2	–	–	–	–
1500	–	4.3	5.8	7.3	8.8	–	–	–	–
1800	–	–	5.5	7.3	8.8	–	–	–	–
2100	–	–	–	7.0	8.5	–	–	–	–
2400	–	–	–	–	8.2	–	–	–	–
<b>75mm x 25mm Corrugation</b>									
900	2.7	3.4	–	–	–	–	–	–	–
1200	2.7	3.4	4.6	–	–	–	–	–	–
1500	2.4	3.0	4.3	5.5	6.7	–	–	–	–
1800	2.4	3.0	4.3	5.5	6.7	–	–	–	–
2100	2.4	3.0	4.3	5.5	6.7	–	–	–	–
2400	–	3.0	4.3	5.5	6.7	–	–	–	–
2700	–	–	4.3	5.5	6.4	–	–	–	–
3000	–	–	–	5.2	6.4	–	–	–	–
<b>152mm x 51mm Corrugation</b>									
1810	–	–	3.7	4.6	5.2	5.8	6.7	–	–
2120	–	–	3.4	4.3	5.2	5.8	6.7	7.3	8.2
3050	–	–	3.4	4.3	4.9	5.5	6.4	7.3	8.2
3670	–	–	3.4	4.0	4.9	5.5	6.4	7.0	7.9
4290	–	–	3.0	4.0	4.9	5.5	6.4	7.0	7.9
4910	–	–	3.0	4.0	4.9	5.2	6.1	7.0	7.9
5530	–	–	–	3.7	4.6	5.2	6.1	7.0	7.9
6150	–	–	–	–	4.6	5.2	6.1	6.7	7.6

**Notes:** \*Where two thicknesses are shown, top is corrugated steel pipe and bottom is structural plate.

**Table 7.18 Allowable Span (ft) for CSP Flowing Full**

Diameter of Pipe (in.)	Specified Steel Thickness* (in.)								
	0.064	0.079	0.109	0.138	0.168	0.188	0.218	0.249	0.280
			0.111	0.140	0.170				
<b>2<sup>2</sup>/<sub>3</sub> x 1/2 in. Corrugation</b>									
24	13	15	20	—	—	—	—	—	—
36	12	15	20	25	—	—	—	—	—
48	11	14	19	25	30	—	—	—	—
60	—	14	19	24	29	—	—	—	—
72	—	—	18	24	29	—	—	—	—
84	—	—	—	23	28	—	—	—	—
96	—	—	—	—	27	—	—	—	—
<b>5 x 1 in. or 3 x 1 in. Corrugation</b>									
36	9	11	—	—	—	—	—	—	—
48	9	11	15	—	—	—	—	—	—
60	8	10	14	18	—	—	—	—	—
72	8	10	14	18	22	—	—	—	—
84	8	10	14	18	22	—	—	—	—
96	—	10	14	18	22	—	—	—	—
108	—	—	14	18	21	—	—	—	—
120	—	—	—	17	21	—	—	—	—
<b>6 x 2 in. Corrugation*</b>									
72	—	—	12	15	17	19	22	—	—
84	—	—	11	14	17	19	22	24	27
120	—	—	11	14	16	18	21	24	27
144	—	—	11	13	16	18	21	21	27
168	—	—	10	13	16	18	21	23	26
192	—	—	10	13	16	17	20	23	26
216	—	—	—	12	15	17	20	23	26
240	—	—	—	—	15	17	20	22	25

**Notes:** \*Where two thicknesses are shown, top is corrugated steel pipe and bottom is structural plate.

## STRUCTURAL DESIGN FOR CSP FIELD JOINTS

For many years, the design of field joints for conduits has been a “cookbook” or “recipe” process. That is, all joint details and dimensions were spelled out based on traditional mechanical devices. Little thought was given to the functional requirements of individual pipe jobs, the arbitrary “hardware” being spelled out in most specifications.

More recently, rational structural requirements have been developed for field joints in Corrugated Steel Pipe. Section 26.4 of the AASHTO Bridge Specification contains this important design information. For the convenience of the reader, this section of the AASHTO Specification (adapted to metric format) is reprinted below.

It should be noted that the AASHTO Specification establishes values for required strength parameters of field joints. It does not define any test procedures to measure these values for a specific joint design. It does provide that such values may be determined either by calculation or test.

Many designers have no recourse to make tests and may be unsure of what calculations to make. Such tests and calculations have been made by public agencies and are available.

## “26.4 ASSEMBLY

### 26.4.1 General

Corrugated metal pipe and structural plate pipe shall be assembled in accordance with the manufacturer’s instructions. All pipe shall be unloaded and handled with reasonable care. Pipe or plates shall not be rolled or dragged over gravel or rock and shall be prevented from striking rock or other hard objects during placement in trench or on bedding.

Corrugated metal pipe shall be placed on the bed starting at down stream end with the inside circumferential laps pointing downstream.

Bituminous coated pipe and paved invert pipe shall be installed in a similar manner to corrugated metal pipe with special care in handling to avoid damage to coatings. Paved invert pipe shall be installed with the invert pavement placed and centered on the bottom.

Structural plate pipe, pipe arches, and arches shall be installed in accordance with the plans and detailed erection instructions. Bolted longitudinal seams shall be well fitted with the lapping plates parallel to each other. The applied bolt torque for 19mm (3/4 in.) diameter high strength steel bolts shall be a minimum of 136 Nm (100 ft-lbs) and a maximum of 407 Nm (300 ft-lbs). For 19mm (3/4 in.) diameter aluminum bolts, the applied bolt torque shall be a minimum of 136 Nm (100 ft-lbs) and a maximum of 204 Nm (150 ft-lbs). There is no structural requirement for residual torque; the important factor is the seam fit-up.

Joints for corrugated metal culvert and drainage pipe shall meet the following performance requirements.



Speed and ease of installation is a major factor in the choice of CSP for storm drainage.

## **26.4.2 Joints**

Joints for corrugated metal culverts and drainage pipe shall meet the following performance requirements.

### **26.4.2.1 Field Joints**

Transverse field joints shall be of such design that the successive connection of pipe sections will form a continuous line free from appreciable irregularities in the flow line. In addition, the joints shall meet the general performance requirements described in items 26.4.2.1 through 26.4.2.3. Suitable transverse field joints, which satisfy the requirements for one or more of the subsequently defined joint performance categories, can be obtained with the following types of connecting bands furnished with the suitable band-end fastening devices.

- a. Corrugated bands.
- b. Bands with projections.
- c. Flat bands.
- d. Bands of special design that engage factory reformed ends of corrugated pipe.
- e. Other equally effective types of field joints may be used with the approval of the Engineer.

### **26.4.2.2 Joint Types**

Applications may require either “standard” or “special” joints. Standard joints are for pipe not subject to large soil movements or disjoining forces; these joints are satisfactory for ordinary installations, where simple slip-type joints are typically used. Special joints are for more adverse requirements such as the need to withstand soil movements or resist disjoining forces. Special designs must be considered for unusual conditions as in poor foundation conditions. Downrain joints are required to resist longitudinal hydraulic forces. Examples of this are steep slopes and sharp curves.

### **26.4.2.3 Soil Conditions**

- a. The requirements of the joints are dependent on the soil conditions at the construction site. Pipe backfill which is not subject to piping action is classified as “Nonerrodible.” Such backfill typically includes granular soil (with grain sizes equivalent to coarse sand, small gravel, or larger) and cohesive clays.
- b. Backfill that is subject to piping action, and would tend to infiltrate the pipe to be easily washed by exfiltration of water from the pipe, is classified as “Erodible.” Such back fill typically includes fine sands and silts.
- c. Special joints are required when poor soil conditions are encountered such as when the backfill or foundation material is characterized by large soft spots or voids. If construction in such soil is unavoidable, this condition can only be tolerated for relatively low fill heights, because the pipe must span the soft spots and support imposed loads. Backfills of organic silt, which are typically semi-fluid during installation, are included in this classification.

**Table 7.19 AASHTO Categories of Pipe Joints**

	Soil Condition				Downdrain
	Nonerrodible		Erodible		
	Joint Type		Joint Type		
	Standard	Special	Standard	Special	
Shear	2%	5%	2%	5%	2%
Moment <sup>a</sup>	5%	15%	5%	15%	15%
Tensile 0 - 1050 mm Dia. (0 - 42 in.)	0	22 kN (5000 lb)	—	22 kN (5000 lb)	22 kN (5000 lb)
1200 - 2100 mm Dia. (42 - 84 in.)	—	44 kN (10,000 lb)	—	44 kN (10,000 lb)	44 kN (10,000 lb)
Joint Overlap <sup>c</sup> (min.)	267 mm (10.5 in.)	NA	267 mm (10.5 in.)	NA	NA
Soiltightness <sup>b</sup>	NA	NA	0.3 or 0.2	0.3 or 0.2	0.3 or 0.2
Watertightness	See paragraph 26.4.2.4(f)				

- Notes:**
- See paragraph 23.3.1.5.4(b).
  - Minimum ratio of D85 soil size to size of opening 0.3 for medium to fine sand and 0.2 for uniform sand.
  - Alternate requirement. See article 23.3.1.5.4(e).  
Structural plate pipe, pipe-arches, and arches shall be installed in accordance with the plans and detailed erection instructions.

#### 26.4.2.4 Joint Properties

The requirements for joint properties are divided into the six categories given in Table 26.4. Properties are defined and requirements are given in the following paragraphs (a) through (f). The values for various types of pipe can be determined by a rational analysis or a suitable test.

(a) *Shear Strength*—The shear strength required of the joint is expressed as a percent of the calculated shear strength of the pipe on a transverse cross section remote from the joint.

(b) *Moment Strength*—The moment strength required of the joint is expressed as a percent of the calculated moment capacity of the pipe on a transverse cross section remote from the joint.

(c) *Tensile Strength*—Tensile strength is required in a joint when the possibility exists that a longitudinal load could develop, which would tend to separate adjacent pipe section.

(d) *Joint Overlap*—Standard joints that do not meet the moment strength alternatively shall have a minimum sleeve width overlapping the abutting pipes. The minimum total sleeve width shall be as given in Table 26.4. Any joint meeting the requirements for a special joint may be used in lieu of a standard joint.

(e) *Soiltightness*—Soiltightness refers to openings in the joint through which soil may infiltrate. Soiltightness is influenced by the size of the opening (maximum dimension normal to the direction that the soil may infiltrate) and the length of the channel (length of the path along which the soil may infiltrate). No opening may exceed 25 mm (1 in.). In addition, for all categories, if the size of the opening exceeds 3 mm (1/8 in.), the length of the channel must be at least four times the size of the opening. Furthermore, for nonerrodible or errodible soils, the ratio of

D<sub>85</sub> soil size to size of opening must be greater than 0.3 for medium to fine sand or 0.2 for uniform sand; these ratios need not be met for cohesive backfills where the plasticity index exceeds 12. As a general guideline, a backfill material containing a high percentage of fine grained soils requires investigation for the specific type of joint to be used to guard against soil infiltration. Alternatively, if a joint demonstrates its ability to pass a 14kPa (2 lb/in.<sup>2</sup>) hydrostatic test without leakage, it will be considered soil tight.

(f) *Watertightness*—Watertightness may be specified for joints of any category where needed to satisfy other criteria. The leakage rate shall be measured with the pipe in place or at an approved test facility. The adjoining pipe ends in any joint shall not vary more than 13 mm (0.5 in.) diameter or more than 38 mm (1.5 in.) in circumference for watertight joints. These tolerances may be attained by proper production controls or by match-marking pipe ends.”

**Note:** Joints that do not meet these requirements may be wrapped with a suitable geotextile.

## BIBLIOGRAPHY

- Abel, J. F., Falby, W. E., Kulhawy, F. H., Selig, E. T., “Review of the Design and Construction of Long-Span, Corrugated Culverts,” August 1977, Federal Highway Administration, Office of Research and Development, 400 7th Street, SW, Washington, DC 20590.
- Bacher, A. E., “Proof Testing of a Structural Plate Pipe with Varying Bedding and Backfill Parameters,” Federal Highway Administration Reports in Progress, California Department of Transportation, Sacramento, CA 95805.
- Bakht, Baider, “Live Load Testing of Soil-Steel Structures”, SDR-80-4. August 1980, Ministry of Transportation and Communications, 1200 Wilson Avenue, Central Building, Downsview, Ontario M3M 1J8. ASTM Standards, Vol. 01.06.
- Bulletin No. 22, 1936, University of Illinois Engineering Experiment Station.
- Burns, J. A., and Richard, R. H., “Attenuation of Stresses for Buried Cylinders,” *Proceedings of a Symposium on Soil-Structure Interaction*, University of Arizona, Sept. 1964, pp. 378-392.
- Demmin, J. “Field Verification of Ring Compression Design,” *Highway Research Record No. 116*, 1966, Transportation Research Board, National Academy of Sciences, 2101 Constitution Ave., Washington, DC 20418, pp. 36-80.
- Duncan, J. M., “Soil-Culvert Interaction Method for Design of Culverts,” *Transportation Research Record 678*, 1978, *Transportation Research Board, National Academy of Sciences*, 2101 Constitution Avenue, Washington, DC 20418, pp. 53-59.
- Allgood, J. R., “Structures in Soils Under High Loads,” National Structural Engineering Meeting, American Society of Civil Engineers, April 1970.
- Handbook of Steel Drainage & Highway Construction Products*, 3rd ed., American Iron and Steel Institute, 1133-15th St. NW, Washington, DC 20005-2701, 1983, 414 pp.
- Heog, K., “Stresses Against Underground Cylinders,” *Journal of Soil Mechanics and Foundation Division*, American Society of Civil Engineers, Vol. 94, SM4, July 1968, pp. 833 858.
- Katona, M. G., et al., “CANDE-A Modern Approach for Structural Design and Analysis of Buried Culverts,” FHWARD-77-5, Oct. 1976, Federal Highway Administration, 400 7th Street, SW, Washington, DC 20590.
- Klöppel, K., and Glock, D. (1970), “Theoretische und Experimentelle Untersuchungen zu den Traglast-problem beigewei-chen, in die Erde eingebetterte Röhre.” *Publication Nr. 10 der Institut für Statik und Stahlbau der Technischen Hochschule*, Darmstadt, Germany.
- Lane, W. W., “Comparative Studies on Corrugated Metal Culvert Pipes,” Building Research Laboratory Report No. EES, February 1965, Ohio State University, Columbus, OH.
- Marston, Anson, “The Theory of External Loads on Closed Conduits,” Bulletin No. 96, 1930, Iowa Engineering Experimental Station, Ames, IA, pp. 5-8.



Meyerhof, G. G., and Baikie, L. D., "Strength of Steel Culverts Bearing Against Compacted Sand Backfill," *Highway Research Record No. 30, 1963, Transportation Research Board, National Academy of Sciences*, 2101 Constitution Avenue, Washington, D.C. 20418, pp. 1-14.

Meyerhof, G. G., and Fisher, C L., "Composite Design of Underground Steel Structures," *Engineering Journal of the Engineering Institute of Canada*, Sept. 1963.

"Specifications for Corrugated Structure Plate Pipe, Pipe-Arches and Arches," *Manual of Recommended Practice*, American Railway Engineering Association, 50 F St. NW, Washington, DC 20001.

*Standard Specifications for Highway Bridges, Sixteenth Edition, 1996*, American Association of State Highway and Transportation Officials, 444 North Capitol Street, NW, Suite 225, Washington, DC 20001.

Timoshenko, S. P., and Gere, J.M., *Theory of Elastic Stability*, 2nd ed., McGraw-Hill, New York, 1964.

Watkins, R. K., and Moser, R. P., "The Structural Performance of Buried Corrugated Steel Pipes," Sept. 1969, Utah State University, Logan, Utah, and American Iron and Steel Institute, Washington, DC, 56 pp.

White, H. L., and Layer, J. P., "The Corrugated Metal Conduit as a Compression Ring," *Proceedings of the Highway Research Board*, Vol. 39, 1960, pp. 389-397.

Williams, G. M., "Plans for Pipe Culvert Inlet and Outlet Structure," Circular Memo and Sheets No. G-39-66 to G-44-66, 1966, Federal Highway Administration, 400 7th Street, SW, Washington, DC 20590.



Large diameter twin structures are installed with great savings to the owner.



Installing subaqueous corrugated steel sewer pipe.

## CHAPTER 8

# Durability

---

### INTRODUCTION

Corrugated steel pipe (CSP) has been used successfully since 1896 for storm sewers and culverts throughout the United States and other countries. It continues to provide long service life in installations that cover a wide variety of soil and water conditions.

Since the initial applications before the turn of the century, an estimated 50,000 installations have been the subject of critical investigative research to establish durability guidelines<sup>(1,2)</sup>. The behavior of both the soil side and the effluent side of the pipe have been studied. These studies have shown that CSP provides outstanding durability with regard to soil side effects, and that virtually any required service life can be attained for the waterside by selecting appropriate coatings and/or pavings for the invert.

Of course, all pipe materials show some deterioration with time, and such effects vary with site conditions. To aid the engineer in evaluating site conditions and selecting the appropriate CSP system, the main factors affecting durability and the results of field studies will be reviewed before presenting specific Durability Guidelines.

### FACTORS AFFECTING CSP DURABILITY

#### **Durability in Soil**

The durability of steel pipe in soil is a function of several interacting parameters including soil resistivity, acidity (pH), moisture content, soluble salts, oxygen content (aeration), and bacterial activity<sup>3,4,5</sup>. However, all of the corrosion processes involve the flow of current from one location to another (a corrosion cell). Thus, the higher the resistivity and/or lower the soil moisture content, the greater the durability. Table 8.1 lists typical ranges of resistivity values for the primary soil types<sup>6</sup>.

A study performed by Corpro Companies in 1986 found that soil-side durability is generally not the limiting factor in designing CSP systems. "Survey results indicate that 93.2 percent of the plain galvanized installations have a soil-side service life in excess of 75 years, while 81.5 percent have a soil-side service life in excess of 100 years." In the vast majority of CSP installations, durability is controlled by the invert (water side) of the pipe.

The study also found that soil moisture contents below 17.5 percent did not exhibit any accelerated corrosion. "Under most circumstances, corrosion rates are directly related to soil moisture content. However, for galvanized steel storm sewer and culvert pipe, the soil moisture content primarily affects the activity of any chloride ions present and the chloride's acceleration of the corrosion. Where the soil moisture content was below 17.5 percent, the chloride ion concentration did not have a significant affect on the corrosion rate of the zinc coating."

Most soils fall in a pH range of 6 to 8, which is favorable to durability. Soils with lower pH values (acid soils), which are usually found in areas of high rainfall, tend to be more corrosive.

**Table 8.1 Typical soil resistivities<sup>6</sup>**

Classification	Resistivity Ohm-cm
Clay	750- 2000
Loam	2000-10000
Gravel	10000-30000
Sand	30000-50000
Rock	50000-Infinity*

\*Theoretical

**Table 8.2 Corrosiveness of Soils<sup>7</sup>**

Soil type	Description of soil	Aeration	Drainage	Color	Water Table
I Lightly corrosive	1. Sands or sandy loams 2. Light textured silt loams 3. Porous loams or clay loams thoroughly oxidized to great depths	Good	Good	Uniform color	Very low
II Moderately corrosive	1. Sandy loams 2. Silt loams 3. Clay loams	Fair	Fair	Slight mottling	Low
III Badly corrosive	1. Clay loams 2. Clays	Poor	Poor	Heavy texture Moderate mottling	600 mm to 900 mm (2 to 3 ft) below surface
IV Unusually corrosive	1. Muck 2. Peat 3. Tidal marsh 4. Clays and organic soils	Very poor	Very poor	Bluish-gray mottling	At surface; or extreme impermeability

Granular soils that drain rapidly enhance durability. Conversely, soils with a moisture content above 20 percent tend to be corrosive<sup>8</sup>. High clay content soils tend to hold water longer and therefore are more corrosive than well-drained soils. Soil moisture may also contain various dissolved solids removed from the soil itself; this can contribute to corrosion by lowering the resistivity. Conversely, many soil chemicals form insoluble carbonates or hydroxides at buried metal surfaces; this can reduce soil-side corrosion. High levels of chlorides and sulfates will make a soil more aggressive. The relative corrosivity of soils of various physical characteristics is described in Table 8.2<sup>7</sup>.

A computer program to estimate soil-side service life is included in "Final Report, Condition and Corrosion Survey of Corrugated Steel Storm Sewers and Culvert Pipe,"<sup>9</sup> and is available from NCSPA. Several coating systems are available to provide additional soil side protection when necessary. Coatings listed in the Product Usage Guidelines under additional soil side protection are generally considered to provide 100 years service life from a soil side perspective within appropriate environmental conditions.



Plain galvanized CSP satisfied service life requirements for storm drains in this environment.

### **Durability in Water**

There is little difference in the durability of steel in still waters in the pH range of 4.5 to 9.5, because the corrosion products maintain a pH of 9.5 at the steel surface<sup>10</sup>. The influence of dissolved gases can be an important factor. Increasing levels of dissolved oxygen and carbon dioxide can accelerate corrosion. The most important effect of carbon dioxide in water relates to its interference with the formation of the protective calcium carbonate films that frequently develop on pipe surfaces, particularly in hard waters. Dissolved salts can increase durability by decreasing oxygen solubility, but can increase corrosion if they ionize and decrease resistivity.

All metals form some type of corrosion product when they corrode, regardless of whether they are protective metallic coatings such as aluminum or zinc or the base steel. Typically the corrosion product, such as an oxide, is more stable and its buildup will result in a decreasing corrosion rate. In practice, corrosion products formed through the galvanic cell (pit) may deposit in small discontinuities in the coating and serve to stifle further corrosion just as films of corrosion products protect solid surfaces. Thus, the development of scales on metal surfaces is an important consideration when using metals in waters.<sup>11</sup>

Field studies have shown that the portion the pipe most susceptible to corrosion is the invert<sup>12, 13, 14</sup>. This should not be surprising because the invert tends to be exposed to water flow for a longer time and, in some cases, it may also be subject to abrasion.

### **Resistance to Abrasion**

In most cases, storm sewers tend to have modest slopes and do not have a bedload present to experience any significant abrasion problems. However, abrasion can become significant where flow velocities are high, over about 5 m/s (15 ft/s) and bedload is present. The amount of wear increases if rock or sand is washed down the invert, but is small when the bed load is of a less abrasive character. In most cases, abrasion level 2 as defined in this chapter, should be used for service life prediction. Various invert treatments can be applied if significant abrasion is anticipated.

### Field Studies of Durability

Reference to field studies of CSP performance in the region of application under consideration is often the most positive way to appraise CSP durability. Over many years, such studies have been made by various state, federal, and industry investigators and now provide a wealth of accumulated information.

### State Studies

California surveyed the condition of pipe at hundreds of locations and developed a method to estimate life based on pH and resistivity<sup>15, 16</sup>. A design chart (AISI) derived from this work will be presented subsequently. Investigations in Florida<sup>17</sup>, Louisiana<sup>18</sup>, Idaho<sup>19</sup>, Georgia<sup>20</sup>, Nebraska<sup>21</sup>, and Kansas<sup>22</sup> showed that the method was too conservative compared to their actual service experience. Conversely, studies in the northeast and northwest regions of the United States indicated that the method might be too liberal in those regions because of the prevalence of soft water.

The results of the various investigations illustrate the variety of conditions that can be found throughout the country, and emphasize the need for proper guidance in coating selection. Nevertheless, the AISI method appears to be the most reasonable basis available for general use. Its generally conservative nature for storm sewer applications can be judged by reviewing the basis of the study which included the effects of abrasion not found in storm sewers.

The California study included the combined effects of soil corrosion, water corrosion, and abrasion on the durability of CSP culverts that had not received special maintenance treatment. The pipe invert, which could easily be paved to extend life, was found to be the critical area. The predictive method developed



Joining factory made CSP into large structural plate storm drain.

depended on whether the pH exceeded 7.3. Where the pH was consistently less than 7.3, the study was based on pipes in high mountainous regions with the potential for significant abrasion. Also, at least 70 percent of the pipes were expected to last longer than indicated by the chart. Thus, the method should be conservative for storm sewers where the effects of abrasion are modest.

Where the pH was greater than 7.3, the study was based on pipes in the semi-arid and desert areas in the southern part of California<sup>16</sup>. Durability under those conditions, which was generally excellent, would be dominated by soil-side corrosion because the average rainfall was less than 250mm (10 in.) per year and the flow through the invert was only a few times per year.

### **AISI Study**

In 1978, the AISI made a survey of 81 storm sewers located in the states of Florida, Minnesota, South Dakota, Utah, California, Ohio, Indiana, North Carolina, Virginia, Maryland and Kansas. The study showed that out of the 81 sites inspected, 77 were still in good condition. The age of the sewers ranged from 16 to 65 years. The four that needed maintenance work had an average age of 32 years. One was in an extremely corrosive environment; the resistivity was only 260 ohm-cm, well below recognized minimum values.

### **NCSPA/AISI Study**

In 1986, the NCSPA, with the cooperation of the AISI, commissioned Corrpro Companies, Inc., a corrosion consulting firm located in Medina, Ohio, to conduct a condition and corrosion survey on corrugated steel storm sewer and culvert pipe. The installations investigated were located in 22 states scattered across the United States, and have ages ranging from 20 to 74 years. Soil resistivities range from 1326 to 77000 ohm-cm, and the pH ranges from 5.6 to 10.3. Both galvanized and asphalt-coated pipes are included.

The study<sup>23</sup>, showed that the soil-side corrosion was relatively minimal on most of the pipes examined. Where significant interior corrosion was observed, it was typically limited to the pipe invert. Specific predictive guidelines have been developed on a statistical basis. As observed by others, invert pavements and coatings can be provided, either factory or field applied, to provide significant additional durability. The data indicate that CSP systems can be specified to provide a service life of 100 years in a variety of soil and water conditions.

### **Canadian Studies**

Many studies have been performed in Canada over the years. One of the earliest investigations was carried out by Golder in 1967. Examination of CSP in South-western Ontario (London) confirmed that the California method was appropriate for predicting service life for local conditions. More recently (1993), British Columbia's ministry of transportation inspected 21 structural plate and galvanized bin-type retaining walls. The installations were all more than 20 years old, the oldest was installed in 1933. The test procedure called for 37 mm (1½ in.) diameter coupons to be cut from the structures and be examined for coating thickness in the lab. The soil (and water, where appropriate) was tested for pH and resistivity. The service life was estimated to exceed 100 years on all but two structures.

A very comprehensive study was conducted in the province of Alberta in 1988, inspecting 201 installations for zinc loss, measuring soil and water pH, resistivity as well as electrical potential between the pipe and the soil. The study generated

one of the best technical databases to date. The report concluded that a minimum service life of 50 years would be achieved 83% of the time and the average life expectancy was 81 years. Where a longer design life was required, a simple check of the site soil and water chemistry could confirm the average service life. Where site conditions indicated that this might be a problem, solutions such as thicker pipe walls or alternate coatings can be cost effective options.

## COATINGS FOR CORRUGATED STEEL PIPE

All corrugated steel pipes have a metallic coating for corrosion protection. When the coating selected does not provide the required service life or is outside the appropriate environmental conditions, an alternate coating system can be selected. Often the required service life can also be achieved by increasing the steel pipe wall thickness; this alternative should be weighed against the cost of supplemental coatings. Galvanizing is the most widely used metallic coating and is the basis for the service life Chart shown in Figure 8.3.

### Metallic Coatings

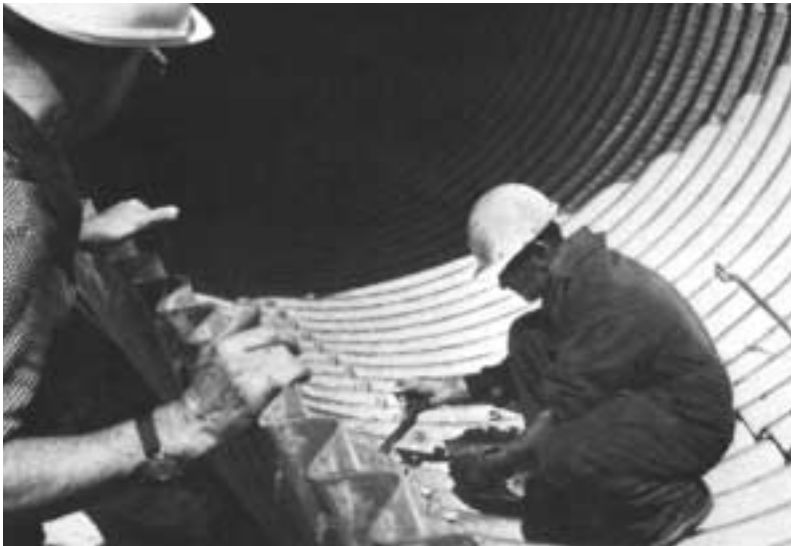
- **Zinc-coated (Galvanized) Steel (AASHTO M36, ASTM 929)** is produced with a coating weight of 610 g/m<sup>2</sup> (2 oz/ft<sup>2</sup>) of surface (total both sides) to provide zinc coating thickness of 43 μm (0.0017 in.) on each surface.
- **4 Ounce Zinc-coated (Galvanized) Steel** is a new coating produced with a coating weight of 1220 g/m<sup>2</sup> (4 oz/ft<sup>2</sup>) of surface (total both sides) to provide zinc coating thickness of 86 μm (0.0034 in.) on each surface. This coating has been evaluated in the lab and is currently being evaluated in field installations. Initial lab tests have indicated increased corrosion and abrasion protection. Specific performance recommendations will be provided when further data is available.
- **Aluminum Coated Type 1 (AASHTO M36, ASTM 929)** is an aluminum coating with 5 to 11% silicon. It is produced with a coating weight of 305 g/m<sup>2</sup> (1 oz/ft<sup>2</sup>) of surface (total both sides) to provide a coating thickness of 48 μm (0.0019 in.) on each surface. Service life will be addressed when sufficient data becomes available.
- **Aluminum Coated Type 2 (AASHTO M274, ASTM 929)** is a pure aluminum coating (no more than 0.35% silicon). It is produced with a coating weight of 305 g/m<sup>2</sup> (1 oz/ft<sup>2</sup>) of surface (total both sides) to provide a coating thickness of 48 μm (0.0019 in.) on each surface.

### Non-Metallic Coating and Pavings

- **Asphalt Coated (AASHTO M190, ASTM A849).** An asphalt coating is applied to the interior and exterior surface of the pipe with a minimum thickness of 1.3 mm (0.05 in.) in both fully coated and half coated.
- **Invert Paved with Asphalt Material (AASHTO M190, ASTM A849).** A asphalt material is used to fill the corrugations and provide a minimum thickness 3.2 mm (1/8 in.) above the crest of the corrugations for at least 25% of the circumference of round pipe and 40% of the circumference for pipe arch.
- **Invert Paved with Concrete Material (ASTM A849, ASTM A979).** A 75 mm (3 in.) thick high strength concrete layer is placed in the installed pipe for at least 25% of the circumference of round pipe and 40% of the circumference for pipe arch.



- **Fully Lined with Asphalt Material** (ASTM A849). An asphalt material is used to fill the corrugations and provide a minimum thickness 3.2 mm (1/8 in.) above the crest of the corrugations providing a smooth surface over the entire pipe interior.
- **Fully Lined with Concrete Material** (ASTM A849, ASTM A979). A high strength concrete material is used to fill the corrugations and provide a minimum thickness 3.2 mm (1/8 in.) above the crest of the corrugations providing a smooth surface over the entire pipe interior.
- **Invert Coated with Polymerized Asphalt Material** (ASTM A849). A polymer modified asphalt material is used to provide a minimum thickness 1.3 mm (0.05 in.) for at least 25% of the circumference of round pipe and 40% of the circumference for pipe arch.
- **Invert Paved with Polymerized Asphalt Material** (ASTM A849). A polymerized asphalt material is used to fill the corrugations and provide a minimum thickness 1.3 mm (0.05 in.) above the crest of the corrugations for at least 25% of the circumference of round pipe and 40% of the circumference for pipe arch.
- **Polymer Precoated** (AASHTO M245, ASTM A742). Typically film applied laminates over protective metallic coatings. The 10/10 grade (10 mils thickness, each side) is the primary product used.
- **Aramid Fiber Bonded Asphalt Coated** (ASTM A885). Provides an aramid fiber fabric embedded in the zinc coating while it is still molten, which improves bonding to the asphalt coating.



Construction crew assembling structural plate pipe.

**Figure 8.1** Product Usage Guidelines for CSP

COATING	WATERSIDE						
	Normal Conditions	Mildly Corrosive	Corrosive	Non-Abrasive/Low Abrasion (Lvl. 1 & 2)	Moderate Abrasion (Level 3)	High Abrasion (Level 4)	Provides Additional Soil Side Protection
Zinc Coated (Galvanized)	★	★	○	○	○	○	○
Aluminum Coated Type 2	○	○	○	○	○	○	○
Asphalt Coated	○	○	○	○	○	○	○
Asphalt Coated and Paved	○	○	○	○	○	○	○
Polymerized Asphalt Invert Coated*	○	○	○	○	○	○	○
Polymer Precoated	○	○	○	○	○	○	○
Polymer Precoated and Paved	○	○	○	○	○	○	○
Polymer Precoated w/ Polymerized Asphalt	○	○	○	○	○	○	○
Aramid Fiber Bonded Asphalt Coated	○	○	○	○	○	○	○
Aramid Fiber Bonded and Asphalt Paved	○	○	○	○	○	○	○
High Strength Concrete Lined	○	○	○	○	○	○	○
Concrete Paved Invert (75mm (3") Cover)	○	○	○	○	○	○	○

\* Use Asphalt Coated Environmental Ranges for Fully Coated Product

## PROJECT DESIGN LIFE

The question often arises as to what project life to use for designing a storm sewer system. In a survey of 14 cities in the southeastern United States, appropriate agencies were asked, "In designing storm sewer systems, what life and use expectancy is used?" Of the total, 71 percent responded that 50 years or less was acceptable for storm sewer life<sup>24</sup>. Obviously, excessively long design lives are undesirable as they tend to inflate the initial cost and ignore the possibility of function obsolescence.

## DURABILITY GUIDELINES

Coating selection and service life prediction can be determined using the Durability Guidelines below. Product Usage Guidelines in Figure 8.1 should be considered as general guidance when considering coatings for specific environments and should be used in conjunction with the Environmental Ranges and the Environmental Guidelines (Fig. 8.2) that follow.

### Environmental Ranges

- Normal Conditions:   pH = 5.8 – 9.0   for R > 2000 ohm-cm
- Mildly Corrosive:     pH = 5.0 – 5.8   for R = 1500 to 2000 ohm-cm
- Corrosive:             pH < 5.0         for R < 1500 ohm-cm

### Abrasion

Invert Protection/Protective Coatings can be applied in accordance with the following criteria. Abrasion velocities should be evaluated on the basis of frequency and duration. Consideration should be given to a frequent storm such as a two-year event ( $Q_2$ ) or mean annual discharge ( $Q_{2.33}$ ) or less when velocity determination is necessary.

### Abrasion Levels

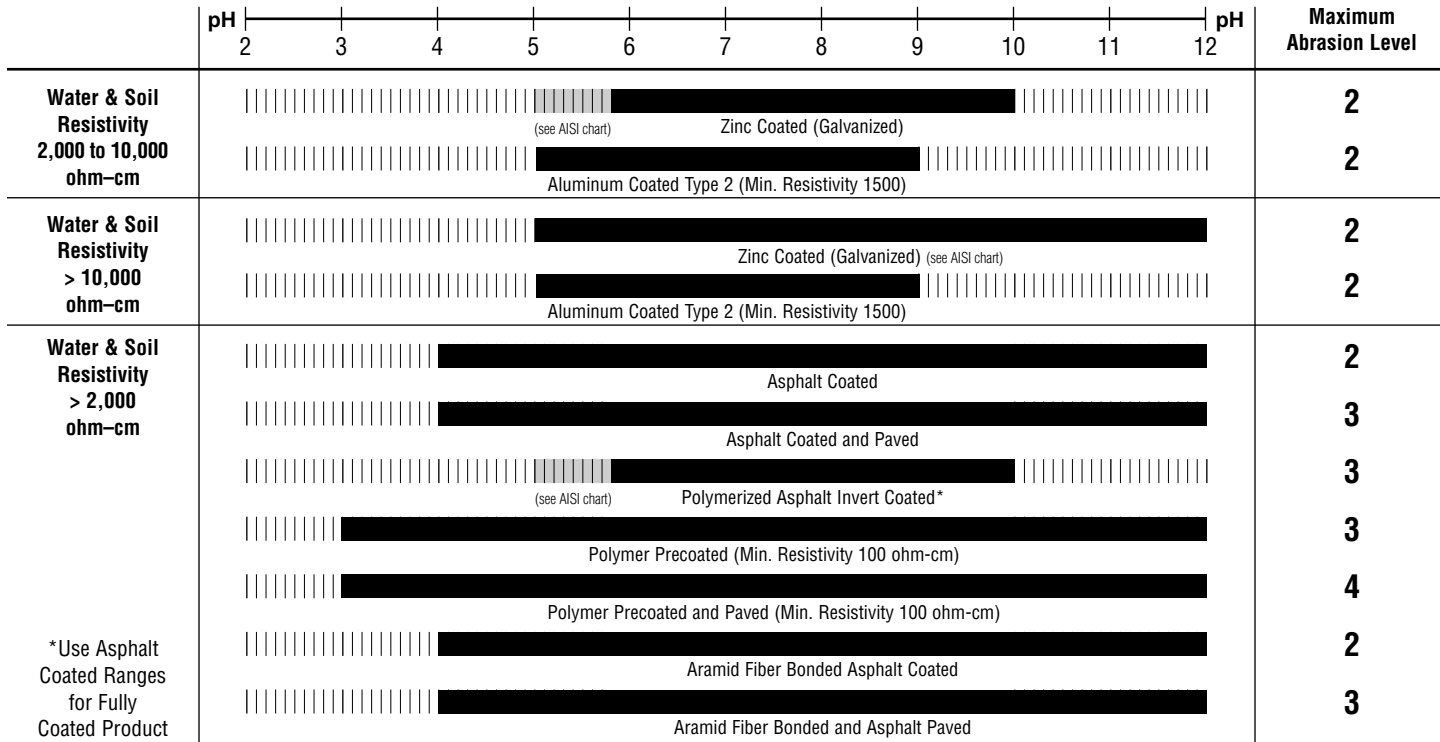
The following definitions are provided as guidance to evaluate abrasion conditions when necessary.

- **Non-Abrasive** (Level 1): No bedload regardless of velocity or storm sewer applications.
- **Low Abrasion** (Level 2): Minor bedloads of sand and gravel and velocities of 5 ft./sec. or less.
- **Moderate Abrasion** (Level 3): Bedloads of sand and gravel with velocities between 5 and 15 ft./sec.
- **Severe Abrasion** (Level 4): Heavy bedloads of gravel and rock with velocities exceeding approximately 15 ft./sec.

## SERVICE LIFE OF METALLIC COATINGS

As discussed above, CSP coatings can be classified into two broad categories, metallic and non-metallic coatings. Metallic coatings commercially available include zinc-coated (galvanized) and aluminum coated (Type 2). Several non-metallic coatings are available as shown in this document. The following discussion explains the differences and similarities of the two metallic coatings.

**Figure 8.2** Environmental Guidelines for Corrugated Steel Pipe



\*Use Asphalt Coated Ranges for Fully Coated Product

- **Zinc-Coated (Galvanized)**<sup>25</sup> — Zinc corrodes much more slowly than steel in natural environments and it galvanically protects steel at small discontinuities in the coating. Its excellent resistance to corrosion is due to the formation of protective films on zinc during exposure. On the average, the rate of attack of zinc is approximately 1/25 that of steel in most atmospheres and various waters.

High corrosion rates in strongly acidic and strongly alkaline solutions can be attributed to the absence of film on the metal surface (stable films are present on the surface when the corrosion rates are low). Lab test indicated stable films in the pH range from about 6 to 12.5.

- **Aluminum Coated Type 2** — “Aluminum is a reactive metal, but it develops a passive aluminum oxide coating or film that protects it from corrosion in many environments.”<sup>26</sup> This film is quite stable in neutral and many acid solutions but is attacked by alkalis greater than a pH of 9. From a corrosion standpoint, aluminum has an advantage over galvanized in lower pH and in soft water due to the formation of the oxide film. (Soft waters are generally classified as waters with a hardness of 50 parts per million CaCO<sub>3</sub> or less.) The coatings are essentially equal under abrasion and in waters where the zinc oxide film forms rapidly.

### Service Life

The service life of zinc coated galvanized is determined using the AISI Chart as discussed below. This chart predicts a variable service life based on pH and resistivity of water and soil and has been an industry standard for many years. Many specifying agencies view service life of aluminum coated type 2 as having additional service life over galvanized<sup>(27, 28, 29, 30)</sup>. This advantage varies throughout the country from minimal to significant depending on the environment and the geographic location. Users are encouraged to review the practices in their area.

For the purposes of this Guide, aluminum coated type 2 can provide a service life range of a minimum 1.3 times the AISI chart for galvanized (roughly 1 gage) and up to 75 years (possibly more) in the appropriate environmental conditions. This is consistent with the range of practice by state and federal specifying agencies. The specific multiplier used for design purposes should be based on comparable experience under similar environmental conditions. There may be conditions where the actual performance is more than or less than this range. The significant advantage appears to be either for more corrosive effluent or soft waters where the protective scale forms rapidly for aluminum. In benign environments or where protective scales form rapidly on zinc, there may be little advantage.

### AISI Method for Service Life Prediction

The service life of CSP can be reasonably predicted based on the environmental conditions, the thickness of the steel, and life of the coating. The most practical method of predicting the service life of the invert is with the AISI (American Iron and Steel Institute) chart shown above. This chart is based on 16 gage galvanized CSP with a 610 g/m<sup>2</sup> (2 oz/ft<sup>2</sup>) coating and can be applied to other thicknesses with the appropriate factor. See discussion above for estimating the service life of aluminum coated type 2.

The AISI chart, which gives service life in terms of resistivity and pH, was developed from a chart originally prepared by the California Department of Transportation (Caltrans). The Caltrans study of durability was based on life to first

perforation in culverts that had not received any special maintenance treatment. The results included the combined effects of soil-side and interior corrosion, as well as the average effects of abrasion. For pipes where the pH was greater than 7.3, soil-side corrosion controlled and life could be predicted by resistivity. For pipes where the pH was less than 7.3, the interior invert corrosion generally controlled and both resistivity and pH were important. In the field inspection of 7000 culverts in California for Caltrans, Richard Stratfull, Lead Project Investigator, states he “has no memory of a corrosion perforation being initially found other than in the invert.” At least 70 percent of the pipes were expected to last longer than the chart prediction.

The consequences of small perforations are minimal in a gravity flow pipe such as most storm sewers and culverts and do not accurately reflect the actual service life. Because of this fact, the original curves were converted by Stratfull to average service life curves using data on weight loss and pitting in bare steel developed by the National Institute of Standards and Technology. Since storm sewers and culverts are usually designed with a structural safety factor of at least 2.0, a significant safety factor of 1.5 remains at the end of the service life predicted by the chart. Thus, use of the chart is considered reasonably conservative. The Caltrans Method may be appropriate for use under pressure applications. Where service life is controlled by invert performance, rehabilitation of the invert at the end of the predicted life can extend service life significantly

## SERVICE LIFE OF NON-METALLIC COATINGS

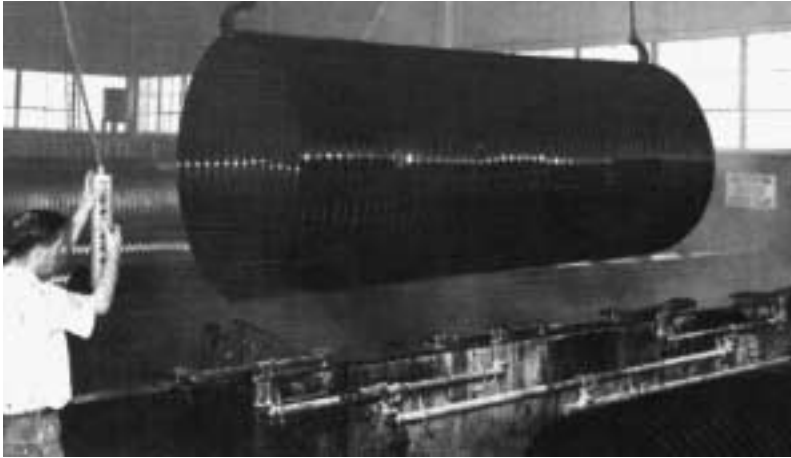
Non-metallic coatings offer advantages over metallic coatings in the form of increased abrasion resistance, wider environmental ranges and longer service life. Inherent in these coatings is less variability in performance which is why specific add-on service life values are recommended under various abrasion levels.

**Asphalt Coated** – Asphalt coatings are generally used for soil-side protection but also provide additional waterside protection. Numerous studies have concluded that asphalt coating typically provides 10 years additional service life to the inside of the pipe<sup>17,18,20,31,32</sup>. Asphalt coatings provide much higher service life on the soil-side and inherently extend the environmental ranges for soil conditions. According to Corpro<sup>23</sup>, “study results indicate that the addition of an asphalt coating may have provided a soil side service life in excess of 100 years.”

**Asphalt Coated and Paved** – Asphalt coated and paved provide both additional service life and added abrasion protection on the water side of the pipe. Based on several studies, coated and paved is considered to provide an additional 30 years service life under most abrasion levels<sup>17,18,20,31,32,33,34</sup>. This is considered a very conservative estimate for non abrasive and low abrasion (level 1 and 2).

**Polymerized Asphalt Invert Coated** – Polymerized asphalt provides improved adhesion and abrasion resistance over standard asphalt products<sup>35</sup>. Full scale abrasion tests conducted by Ocean City Research indicate no deterioration of the coating under moderate abrasion (level 3)<sup>36</sup>.

Based on independent test lab results using test method ASTM A926, results indicate that the commercially available polymerized asphalt coating lasts at least 10 times longer than standard asphalt coating and at least three times longer than standard culvert coated and paved (Caltrans).



Asphalt coating corrugated steel pipe.

**Polymer Precoat** – Polymer precoat provides excellent adhesion to the base steel and extended corrosion and abrasion resistance. The service life recommendation are based on extensive lab and field tests <sup>(35,37,38,39,40)</sup>. According to PSG<sup>39</sup>, “No corrosion was observed on any of the coated (polymer coated) pipes. We can not find any data to suggest the pipe coating would not provide at least one hundred years service.” These sites contained environmental conditions with Resistivity as low as 100 ohm-cm and pH as low as 2.1. In addition, PSG conducted current requirement testing that is designed to determine corrosion activity of a given structure. The current requirement data shows polymer coated structures have up to 10,000 times less corrosion versus bare G210 galvanized. Tests conducted by Ocean City Research indicate polymer coated withstanding abrasion level three conditions. (Note: Corrosion conditions under extreme limits of the environmental ranges may require adjusting add-on service life values).

**Polymer Precoat and Asphalt Paved** – Polymer precoat and asphalt paved benefits from the excellent adhesion of the polymer precoat to the base steel and the subsequent adhesion of the paving to the precoat. According to laboratory and field tests <sup>39, 41</sup>, the combination of the three coatings results in a pipe which is highly resistant to acidic effluent. The bituminous material has much better adhesion to the polymeric coating than it does to the galvanizing.

**Polymer Precoat with Polymerized Asphalt Invert Coated** – Full scale abrasion tests conducted by OCR<sup>36</sup> show equal performance of the polymerized asphalt over polymer precoat as standard asphalt paved. This system has the same bonding characteristics as the polymer precoat and paved. Field sites also indicate improved adhesion and performance<sup>39</sup>.

**Aramid Fiber Asphalt Coated/ Aramid Fiber Asphalt Paved** – The fibers embedded in zinc provide an anchor for the asphalt coating or paving to improve adhesion.

**High Strength Concrete Lined** – Concrete linings are typically used for improved hydraulic performance but also provide additional abrasion protection and extended service life. The use of high strength concrete and metallic coated steel provide the high service life values.

**Concrete Invert Paved** – Concrete inverts provide extreme abrasion protection and extended service life. According to Stratfull<sup>12</sup>, “metal pipe with an invert paved with concrete should provide an indefinite service life if it is of sufficient width, thickness and quality. By calculation, a 4-inch thick coating over the invert steel could be expected to postpone its initial time to corrosion by approximately 7.7 times greater than a 3/4 inch coating.”

### Additional Service Life

Additional service life can be provided by increasing the thickness of the base steel in accordance with the factors shown in the Chart for Estimating Average Invert Service Life or with the use of additional coating systems. Add-on service life values are provided in the Table 8.4 for protective coatings applied to metallic coated CSP.

**Table 8.3** Add-On Service Life for Non-Metallic Coatings, in years

COATING	WATER SIDE			References
	Level 1 & 2	Level 3	Level 4	
Asphalt Coated	10	N/R	N/R	17, 18, 20, 31, 32
Asphalt Coated and Paved	30	30	30	17, 18, 20, 31, 32, 33, 34
Polymerized Asphalt Invert Coated	45	35	N/R	28, 35, 36
Polymer Precoat	80+	70	N/R	35, 37, 38, 39, 40
Polymer Precoat and Paved	80+	80+	30	36, 39, 41
Polymer Precoat with Polymerized Asphalt Invert Coated	80+	80+	30	36, 39
Aramid Fiber Asphalt Coated	40	N/R	N/R	37
Aramid Fiber Asphalt Paved	50	40	N/R	37
High Strength Concrete Lined	75	50	N/R	12, 42
Concrete Invert Paved (75mm (3 in.) cover)	80+	80+	50	12, 42

N/R = Not Recommended

### AISI Method for Service Life Prediction

As explained earlier, the original California method referred to previously was based on life to first perforation of an unmaintained culvert. However, the consequences of small perforations in a storm sewer are usually minimal. Therefore, the curves on the chart were converted by R.F. Stratfull to “average service life” curves, using data developed on weight loss and pitting of bare steel samples by the NIST (National Institute of Standards and Technology, formerly the National Bureau of Standards)<sup>12</sup>.

Figure 8.3 provides the resulting chart for estimating the average invert service life for CSP storm sewers. The chart limits useful service life to a 25% metal loss. Even with a minimum design factor of safety, this provides a structural factor of safety of 1.5 at the end of the average service life.

The calculations used to convert the original chart to an average service life



**Figure 8.3** AISI Chart for Estimating Average Invert Life for Galvanized CSP

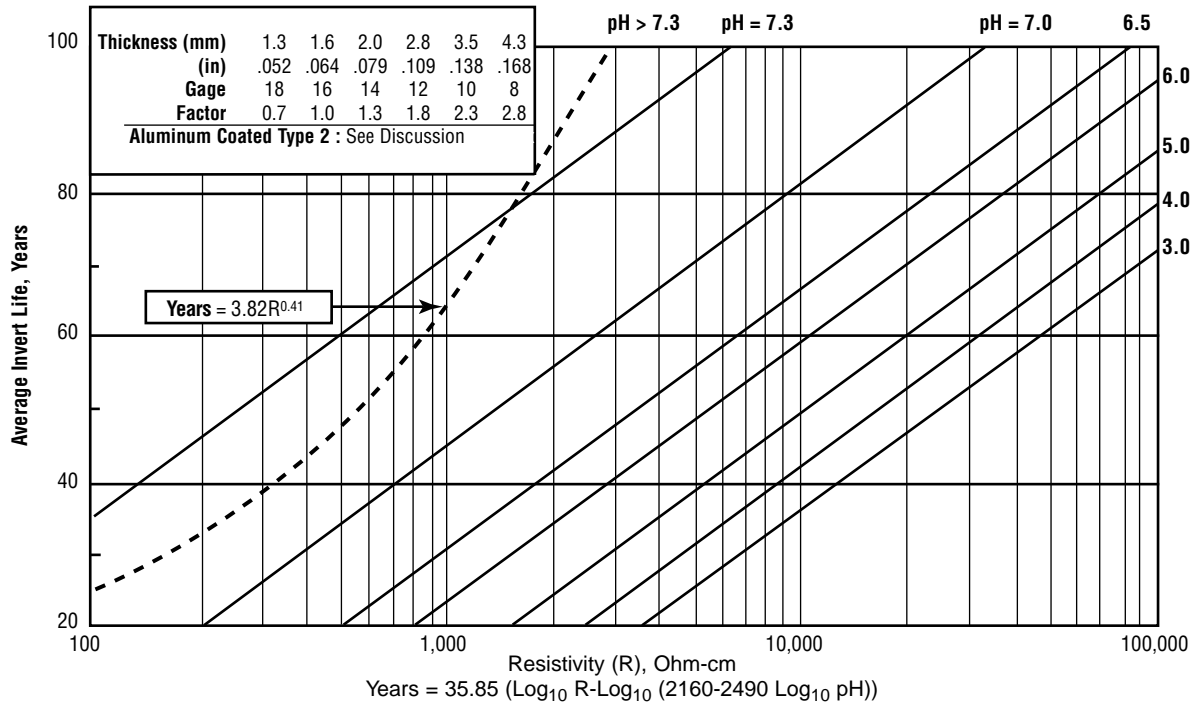


chart were conservative because they were based on corrosion rates for bare steel. The same data set showed that galvanized specimens corrode at a much lower rate.

### Steps in Using the AISI Chart

This durability design chart can be used to predict the service life of galvanized CSP and to select the minimum thickness for any desired service life. Add-on service life values are provided in Table 8.3 for additional coatings.

- 1) Locate on the horizontal axis the soil resistivity (R) representative of the site.
- 2) Move vertically to the intersection of the sloping line for the soil pH. If pH exceeds 7.3 use the dashed line instead.
- 3) Move horizontally to the vertical axis and read the service life years for a pipe with 1.6 mm (0.064 in.) wall thickness.
- 4) Repeat the procedure using the resistivity and pH of the water; then use whichever service life is lower.
- 5) To determine the service life for a greater wall thickness, multiply the service life by the factor given in the inset on the chart.

### EXAMPLE OF DURABILITY DESIGN

The following example illustrates the use of Figure 8.3 for designing a storm sewer project.

Pipe sizes are in the 900 to 2400 mm (36 to 96 in.) range. Site investigation shows native soils to have a pH of 7.2 and a resistivity of 5000 ohm-cm. Storm flow is estimated to have a pH of 6.5, a resistivity of 4500 ohm-cm, and low abrasive conditions. Required service life of the installation is 50 years.

Referring to Figure 8.3, the following life may be obtained for galvanized 1.63 mm (.064 in.) thick pipe:

Outside condition . . . . .	.85 years
Inside Condition . . . . .	55 years (controls)

Therefore, a thickness of 1.63 mm (.064 in.) is satisfactory.

All storm sewer materials and coatings can be degraded by abrasive flows at high velocity. If significant abrasive flow is indicated or additional service life is desired, an appropriate coating or invert treatment should be added.

Many different combinations of pipe and coating systems are possible. However, economic considerations will usually dictate the selection of no more than two or three "allowable" alternatives.

## REFERENCES

1. *Durability of Drainage Pipe*, N. C. H. R. P. Synthesis of Highway Practice No. 50, Transportation Research Board, Washington, DC, 1978.
2. *Symposium on Durability of Culverts and Storm Drains*, Transportation Research Record No. 1001, Transportation Research Board, Washington, DC, 1984.
3. Logan, K. H., *Underground Corrosion*, National Bureau of Standards Circular 450 Washington, DC, 1945.
4. Romanoff, M., *Underground Corrosion*, National Bureau of Standards Circular 579, Washington, DC, 1957.
5. Fitzgerald, J. H. III, *The Future as a Reflection of the Past*, Effects of Soil Characteristics on Corrosion, ASTM STP 1013, Chaker, V., and Palmer, J. D., Editors, ASTM, Philadelphia PA, 1989.
6. Wilson, C. L., Oates, J. A., *Corrosion and the Maintenance Engineer*, 2nd edit. Hart (1968).
7. American Water Works Association, *Steel Pipe - A Guide for Design and Installation*, Manual M11, 1989.
8. Ashworth, V., Googan, C. G., Jacob, W. R., *Underground Corrosion and its Control*, Corrosion Australasia, October, 1986.
9. *Condition and Corrosion Survey: Soil Side Durability of CSP*, Corpro Companies, March, 1991.
10. Coburn, S. K., *Corrosion in Fresh Water*, Metals Handbook, 9th Edition, Vol. 1, ASM, Metals Park, OH, 1978.
11. *Corrosion Basics: An Introduction*, National Association of Corrosion Engineers, 1984.
12. Stratfull, R. F., *Durability of Corrugated Steel Pipe*, Special Publication, United States Steel, Pittsburgh, PA, 1986.
13. Bellair, P. J., and Ewing, J. P., *Metal Loss Rates of Uncoated Steel and Aluminum Culverts in New York*, Research Report 115, Engineering R & D Bureau, NYDOT, Albany, NY, 1984.
14. *Conditioning and Corrosion Survey on Corrugated Steel Storm Sewer and Culvert Pipe*, Bushman, J. B., et al, Corpro Companies, Inc., Medina, OH, 1987. (First Interim Report).
15. Beaton, J. L., and Stratfull, R. F., *Field Test for Estimating Service Life of Corrugated Metal Culverts*, Highway Research Board Proceedings, Vol. 41, Washington, DC, 1962.
16. Stratfull, R. F., *A New Test for Estimating Soil Corrosivity Based on Investigation of Metal Highway Culverts*, Corrosion, Vol. 17 No. 10, NACE, Houston, TX, 1961.
17. Brown, R. F., Kessler, R. J., and Brawner, J. B., *Performance Evaluation of Corrugated Metal Pipes in Florida*, Florida DOT, Gainesville, FL, 1976.
18. Azar, D. G., *Drainage Pipe Study*, Research Report No. 57, LADOT, Baton Rouge, LA, 1971.
19. *Durability of Metal Pipe Culverts*, Idaho Department of Highways, Research Project No. 16, Boise, ID, 1965.
20. Little, H. P., Boedecker, K. J., and Brawner, J. B., *Performance Evaluation of Corrugated Metal Culverts in Georgia*, Southeastern Corrugated Steel Pipe Association, Inc., 1977.
21. *Nebraska Soil Resistivity and pH Investigation as Related to Metal Culvert Life*, Nebraska Department of Roads, 1969.
22. Worley, H. E., and Crumpton, C. F., *Corrosion and Service Life of Corrugated Metal Pipe in Kansas*, Highway Research Record No. 412, 1972.
23. *Condition and Corrosion Survey on Corrugated Steel Storm Sewer and Culvert Pipe*, Bushman, J. B., et al, Corpro Companies, Inc., Medina, OH, 1988 (2nd Interim Report).
24. Pollard, C. N., *A Questionnaire Survey of 14 Cities Concerning the Use of Storm Sewers*, Unpublished survey by the Southeastern Section of the Corrugated Steel Pipe Association, Fayette, AL, 1973.
25. *Zinc: Its Corrosion Resistance*, C.J. Slunder and W.K. Boyd, 1971.
26. *Corrosion Engineering*, Mars G. Fontana, 1986.
27. *Federal Lands Highways Design Guide*, FHWA.
28. California Highway Design Manual, Fifth Edition.
29. Oregon Department of Transportation.
30. *Hydraulics Manual*, Washington State Department of Transportation, 1997.

31. Potter, J. C. *Life Cycle Costs for Drainage Structures, Technical Report GL-87*, U.S. Army Corps of Engineers, Washington, DC, 1987.
32. *Durability of Corrugated Metal Culverts*, John E. Haviland, Peter J. Bellair, Vincent D. Morrell, New York DOT, Bureau of Physical Research, 1967. (DU-163)
33. *Culvert Performance Evaluation*, Materials Division, Washington State Highway Commission, 1965.
34. *Durability of Asphalt Coating and Paving on Corrugated Steel Culverts in New York*, W.W. Renfrew, TRB, 1984 (DU-155)
35. Ocean City Research, *Evaluation Methodology for CSP Coating/Invert Treatments*, 1996.
36. Ocean City Research, 1999.
37. *Evaluation of Drainage Pipe by Field Experimentation and Supplemental Laboratory Experimentation, Final Report*, Louisiana Transportation Research, 1985.
38. *Experimental Culvert Pipe, STH 80*, Wisconsin DOT, 1996.
39. *Field inspection of Polymer Coated CSP*, PSG Corrosion Engineering & Ocean City Research, 1998.
40. *Louisiana Highway Research Drainage Pipe Study*, David G. Azar, 1972. (DU-147)
41. *Pipe Coating Study: Final Report*, Indiana Department of Highways, September, 1982.
42. *Durability of Culverts and Special Coatings for CSP*, FHWA, 1991

**BIBLIOGRAPHY**

- Azar, D. G., *Drainage Pipe Study*, Research Report No. 57, Louisiana Department of Highways, May 1971.
- Beaton, J. L., and R. F. Stratfull, *Field Test for Estimating Service Life of Corrugated Metal Culverts*, Highway Research Board Proceedings, Vol. 41, 1962, pp. 255-272.
- Bednar, L., *Galvanized Steel Drainage Pipe Durability Estimation with a Modified California Chart*, presented at 68th Annual Meeting of Transportation Research Board, Washington, DC, 1989 (to be published).
- Bednar, L., *Durability of Plain Galvanized Steel Drainage Pipe in South America—Criteria for Selection of Plain Galvanized*, *ibid.*
- Brown, R. F., and Richard J. Kessler, *Performance Evaluation of Corrugated Metal Culverts in Florida*, Florida D.O.T., April 1976.
- Corrugated Pipe Durability Guidelines*, FHWA Technical Advisory T 5040.12, October 1979, Federal Highway Administration, Washington, D.C. 20590, 9 pp.
- Cumbaa, Steven L., Gueho, Bruce J., Temple, William H., Evaluation of Drainage Pipe By Field Experimentation And Supplemental Laboratory Experimentation (Final Report) Louisiana Department of Transportation and Development, March 1985.
- Curtice, D. K., and J. E. Funnel, *Comparative Study of Coatings on Corrugated Metal Culvert Pipe*, Southwest Research Institute, San Antonio, Texas, March 1971.
- Durability of Drainage Pipe*, N.C.H.R.P. Synthesis of Highway Practice No. 50, Transportation Research Board, Washington, D.C., 1978.
- Durability of Metal Pipe Culverts*, Idaho Department of Highways, Research Project No. 16, April 1965.
- Fraseoia, R., *Performance of Experimental Metal Culverts, Research Update*, Materials and Research Division, Vermont Agency of Transportation, No. U88-19, 1988.
- Haviland, John E., Bellair, Peter J. and Vincent D. Morrell, *Durability of Corrugated Metal Culverts*, Physical Research Project No. 291, State of New York D.O.T., Albany, November 1967.
- Hayes, C. J., *A Study of the Durability of Corrugated Steel Culverts in Oklahoma*, Oklahoma Dept. of Highways, 1971, 39 pp.
- Hurd, John O., *Field Performance of Protective Linings for Concrete and Corrugated Steel Pipe Culverts*, Transportation Research Board, Washington, D.C., Record Number 1001, 1984.
- Kald, M., *Statewide Survey of Bituminous-Coated Only and Bituminous-Coated and Paved Corrugated Metal Pipe*, Final rep., Maryland State Roads Comm.
- Little, H. P., Boedecker, K. J., and J. B. Brawner, *Performance Evaluation of Corrugated Metal Culverts in Georgia*, April 1977, Southern Corrugated Steel Pipe Association, 1750 Pennsylvania Avenue, NW, Suite 1303, Washington, DC 20006, 120 pp.
- Malcolm, W. J., *Durability Design Method for Galvanized Steel Pipe in Iowa*, Corrugated Steel Pipe Association of Iowa and Nebraska, Spring 1968, 24 pp.
- National Corrugated Steel Pipe Association-Coating Selection Guide for Corrugated Steel Pipe*, National Corrugated Steel Pipe Association, Sewer Manual for Corrugated Steel Pipe, Washington, DC 20006, 1989.
- Nebraska Soil Resistivity and pH Investigation as Related to Metal Culvert Life*, Nebraska Dept. of Roads, April 1969.
- Payer, J. H., Osborne, E. E., Stieglmeyer, W. N., and W. K. Boyd, *Final Report on a Study of the Durability of Asbestos-Bonded Metal Pipe in Sewer Service to Armco Steel Corporation, Battelle Columbus Laboratories*, 505 King Avenue, Columbus, Ohio 43201, July 23, 1976.
- Potter, J.C., Life Cycle Cost for Drainage Structures, Department of the Army, U.S. Corps of Engineers Tech Rep GL-88-2.
- Pyskadlo, Robert M., and Wallace W. Renfrew, *Overview of Polymer Coatings for Corrugated Steel Pipe in New York*,



Well points and wide trenches were necessary to install full-bituminous coated and full-paved CSP in this unstable ground.

# Value Engineering and Life Cycle Cost Analysis

---

## INTRODUCTION

This chapter deals with the important subject of cost efficiency. Today's engineer is turning to rational cost analysis in lieu of subjective selection of materials and designs. This requires both value engineering and least cost analysis. Value engineering is the critical first step to ensure that correct alternates are used in the least cost analysis. Otherwise, the engineer may be comparing apples and oranges.

This manual offers guidelines for designing corrugated steel pipe systems that are structurally adequate, hydraulically efficient, durable and easily maintained. By following these guidelines, equal or superior performance can be realized through use of CSP products. Therefore, the basic techniques of value engineering are applicable. By allowing design and bid alternates, including the proper corrugated steel pipe system, savings on the order of 20% can frequently be realized. Alternative designs offer even more promise and savings of as much as 90% are possible compared with the costs of conventional designs. Thus, innovative use of corrugated steel pipe design techniques can offer truly substantial savings, with no sacrifice in either quality or performance.

## VALUE ENGINEERING

A publication of the AASHTO-AGC-ARTBA entitled "*Guidelines for Value Engineering*" summarizes the basic processes as applied to street and highway construction. Value Engineering provides a formalized approach that encourages creativity both during the design process and after the bid letting. During the design process, it involves the consideration of both alternate products with equal performance and alternative designs. After bid award, it involves the substitution of different project plans together with revised design or materials to meet time constraints, material shortages, or other unforeseen occurrences, which would affect either the completion date or quality of the finished product.

- 1) Cost reductions,
- 2) Product or process improvements, and
- 3) A detailed assessment of alternative means and materials both for construction and maintenance.

Value Engineering is defined by the Society of American Value Engineering as: "The systematic application of recognized techniques which identify the function of a product or service, establish a value for that function and provide the necessary function reliably at the lowest overall cost." In all instances, the required function should be achieved at the lowest possible life cycle cost consistent with requirements for performance, maintainability, safety and aesthetics.

Barriers to cost effectiveness are listed as lack of information, wrong beliefs, habitual thinking, risk of personal loss, reluctance to seek advice, negative attitudes, over-specifying and poor human relations.

It is functionally oriented and consists of the systematic application of recognized techniques embodied in the job plan. It entails:

- 1) Identification of the function,
- 2) Placing a price tag on that function, and
- 3) Developing alternate means to accomplish the function without any sacrifice of necessary quality.

Many Value Engineering recommendations or decisions are borne of necessity involving perhaps the availability of equipment or material, or physical limitations of time and topography. These are the very reasons that it came into being and in these instances, the alternative selected should not be considered an inferior substitute. Such circumstances force us to restudy the function and if the appropriate job plan is carefully followed, the alternative selected should be equal if not better, and capable of functioning within the new limitations.

A Value Engineering analysis of standard plans can be very revealing and beneficial in most cases. This may be done as a team effort on all standards currently in use by an agency or it may be done on a project by project basis. Standard specifications should also be subjected to detailed analysis.

Designers are in some cases encouraged to be production oriented and to prepare completed plans as quickly as possible. However, time and effort are frequently well spent in applying the principles to individual project design.

Do local conditions indicate that receipt of bids on alternate designs is warranted? Do plans permit contractor selection of alternate designs and materials for specific bid items?

These questions may be very pertinent in ensuring the most efficient storm and sanitary sewer designs. Affording contractors an opportunity to bid on alternates may result in a saving that was not previously evident. Permitting alternates may further encourage contractors and suppliers, who would not otherwise do so to show interest in a proposal.



“O-Ring” being placed over the end of the pipe and recessed into the end corrugation.





CSP was a cost effective solution for the Newark Airport.

The utility of value engineering as a cost control technique has long been recognized by the Federal Government. It was first used by the Navy in 1954 and since then 14 Federal Agencies, including the U.S. Army Corps of Engineers, have used these analyses in the design and/or construction of facilities. As an example, the 1970 Federal Aid Highway Act required that for projects where the Secretary deems it advisable, a Value Engineering or other cost reduction analysis must be conducted. In addition, the EPA developed a mandatory Value Engineering analysis requirement for its larger projects and is actively encouraging voluntary engineering studies on its other projects. Thus, these agencies obviously feel that the potential benefit resulting from such analysis far outweighs the cost incurred by the taxpayer in conducting them.

#### INCLUSION OF ALTERNATE MATERIALS IN A PROJECT INDUCES LOWER PRICES.

The following recommendations on alternate designs are reproduced in its entirety from a study by the Sub-Committee on Construction Costs of AASHTO-AGC-ARTBA.

### ALTERNATE DESIGNS AND BIDS ON PIPE

#### ***A) Description of Proposal***

*In many cases, the site conditions pertaining to pipe installations are such that alternative designs involving various pipe products will yield reasonably equivalent end results from the standpoint of serviceability. Moreover, in these cases no one pipe product is clearly less costly than the others, particularly where all suitable products are allowed to compete. Therefore, it is proposed that wherever site conditions will permit, alternative designs be prepared for all types of pipe that*

*can be expected to perform satisfactorily and are reasonably competitive in price and the least costly alternative be selected for use, with the costs being determined by the competitive bidding process.*

### ***B) Examples or References***

*In the absence of unusual site conditions, alternative designs for a typical pipe culvert installation may provide for bituminous coated corrugated metal pipe and reinforced concrete pipe, with a size differential when required for hydraulic performance. In bidding the related construction work, bidders could be required to submit a bid for performing the work with the understanding that the successful bidder could furnish any one of the permitted types of pipe.*

### ***C) Recommendation for Implementation***

*The availability of competitive pipe products should be established on a statewide basis or on a regional basis within a state. Procedures should be instituted, where necessary, to assure that all suitable types of pipe are considered during the design of pipe installations. Any necessary changes in bidding procedures and construction specifications should also be instituted.*



Large 6000 mm (250 in.) diameter “bellmouth inlet” for cooling water intake for thermal power project on floor of Lake Erie is typical of widespread applications of design in steel to rigorous and difficult conditions, where rigid design would either be impractical, or prohibitively costly.

**D) Advantages**

Acceptance of this proposal should permit the greatest feasible amount of competition among pipe products. This will permit all related economic factors to operate freely in establishing the lowest prices for pipe installations.

**E) Precautions**

Complex bidding procedures should not be necessary and should be avoided. In any case, bidders should be fully informed as to how the procedures are intended to operate. Care must be taken to avoid alternative designs in situations where choice of a single design is dictated by site conditions.

There are two basic ways to use Value Engineering: (1) at the design stage to determine the most cost effective material or design to specify without alternates, and (2) to select the most cost-effective bid submitted on alternates.

In the first case it is important to use Value Engineering principles when calculating estimates for various materials being considered. This means including in the estimates all the factors bidders would consider in their bids. Installation cost differences between concrete and corrugated steel pipe result from pipe dimensions, foundation and bedding, required equipment and speed of assembly. Table 9.1 is an actual example from a Northwest storm drain project.

<b>Table 9.1 Value analysis (abbreviated)</b> <b>Storm drain project—Northwest United States.</b> <b>475 m of 1200 mm (1557 ft of 48 in.) diameter</b> <b>and 315 m of 1800 mm (1037 ft of 72 in.) diameter</b>		
Principal factors	Corrugated Steel Pipe	Reinforced Concrete Pipe
Material F.O.B. jobsite:		
1200 mm diameter	\$ 32,697	\$ 56,052
1800 mm diameter	\$ 54,961	\$ 74,664
Installation cost differences:*		
1200 mm diameter		\$ 10,899 more
1800 mm diameter		\$ 15,555 more
*For concrete pipe:		
Increased excavation quantities		
Increased amounts of select backfill and bedding material		
Heavier sections requiring heavier handling equipment		
Short sections requiring more handling time		
Breakage factors high – less material yield		
<b>Total cost</b>	<b>\$ 87,658</b>	<b>\$ 157,170</b>

\*Other items of consideration for Contractor, Engineer or Agency may include several of the following: prompt delivery as needed, minimum engineering and inspection costs, bad weather hazards, minimum interference with other phases of project, or business and residential areas, etc.

In the second case, where alternate bids are taken, it is important to clearly spell out in the plans and specifications the differences in pipe and trench dimensions for concrete and corrugated steel pipe. Foundation, bedding and minimum cover differences may also be significant. Construction time schedule differences could be a factor and should be required to be shown.

### Cost Savings in Alternate Designs

In addition to the savings resulting in allowing pipe alternates in conventional designs, alternative designs based on entirely different water management procedures can offer even more significant savings. Chapter 6 describes the design of storm water recharge systems, which meet environmental requirements in force today without the high cost of advanced waste water treatment systems. By using these techniques on a total system basis, smaller pipe sizes are required than for conventional systems and the cost of the pipe item itself can frequently be reduced.

Another example of an alternative design procedure is the principle of "inlet" control. Most current designs are based on a peak "Q" resulting from hydrologic, flood routing, and hydraulic considerations. Thus, the design is based on the peak discharge at the outlet end derived from the constituent contributions of the upstream network. Inlet control design analyzes the existing drainage system, calculates its capacity, and designs components that restrict the water reaching each part of the system to its rated peak capacity. Excess water is stored at the point of entry and released in a controlled manner after the peak discharge has passed.

An excellent example of the application of value engineering principles in a real situation is quoted in a paper by Thiel. Frequent basement flooding was occurring in areas with combined sewer systems in the Borough of York in Toronto, Canada. Earlier studies recommended separation of the storm and sanitary sewer systems, and this conventional solution was proceeded with for about eight years with a budget of about \$1 million/year. With rapid inflation, it became apparent that no adequate relief would be obtained within a reasonable time span without absorbing further enormous costs.

Mr. Thiel's firm was then engaged to seek alternative solutions to the problem. His task was to accommodate a 2-year design storm without causing surcharge above existing basement floors. As three of the four areas involved were located away from suitable storm water outlets, a system of relief sewers was rejected as unfeasible. By applying the principles of Value Engineering it was possible to show that application of the inlet control method with detention storage was the most cost effective solution by far.

Inlet control was achieved through the use of hydro-break regulators in the system, by either disconnecting downspouts or placing flow regulators in them and by sealing catch basins where positive drainage could be achieved. At low points, storm sewers were provided to carry the water to detention tanks. Storm water would thus be discharged into the combined sewer at a predetermined rate, thereby eliminating flood damage. The Borough was then presented with the following estimates to cover all work in the four areas for three different storm intensities;

2-Year Storm	—	\$110,000
5-Year Storm	—	\$285,000
10-Year Storm	—	\$830,000

As a result, the Borough decided to proceed rapidly with providing protection against a 10-year storm, rather than the 2-year design envisaged, at a cost within 1 year's sewer separation budget.



Adequate, uniform compaction is the secret to building soil and steel structures.

## LIFE-CYCLE COST ANALYSIS

Life-cycle cost analysis (LCC) is an economic evaluation technique. It is well suited to compare alternative designs, with differing cost expenditures over the project life. Calculations are made which convert all relevant costs to their equivalent present value. The alternative with the lowest total present value is the most economical or least cost approach.

LCC analysis is particularly well suited to determine whether the higher initial cost of an alternative is economically justified by reductions in future costs when compared to an alternative with lower initial but higher future costs. This can often be the case when comparing competing bids for storm sewers where pipe alternatives such as corrugated steel (CSP); reinforced concrete (RCP) or plastic pipes are being considered.

LCC methods are commonly included in engineering economic courses or texts. The equations are relatively straightforward. The work is further simplified through the use of financial calculators or computer programs. The NCSPE has a program available which specifically performs LCC analysis in accordance with ASTM: A-930 *Standard Practice for Life-Cycle Cost Analysis of Corrugated Metal Pipes Used for Culverts, Storm Sewers, and Other Buried Conduits*.

As is the case with most evaluation techniques, the real challenge lies in making unbiased assumptions, which produce fair comparisons of alternate designs. For drainage projects, the key engineering assumptions include capacity requirements, project design life, material service life for each alternate under consideration and any future maintenance or repair costs necessary to achieve the project service life. The key economic assumption is the value selected for the discount rate (time value of money). Other economic assumptions, such as the treatment afforded inflation and residual or salvage value, are less critical in their effect on the overall results.



Trenches should be wide enough to permit proper tamping of backfill.

## ENGINEERING ASSUMPTIONS

### **Project Design Life**

The first step in any LCC analysis is to establish the project design life. This should be expressed as the number of years of useful life required of the drainage structure. In the case of some agencies it is already a matter of policy. For example, a 50-year design life for primary state highway culverts is common. In the absence of a mandated project design life, it should reflect the planning horizon for the project as selected by the owner.

A rational determination of design life must consider the potential for future obsolescence. For example, what is the risk that the current design capacity will remain functionally adequate in the future? What action can be taken to increase capacity? Is a parallel line feasible or do the site circumstances dictate removal of the pipe to build a larger structure later? Do you oversize now or not? Arbitrarily choosing an excessive design life as a hedge against significant, unanticipated future events or costs may feel prudent but can prove wasteful. For example, consider how many structures that were carefully designed 30 or 40 years ago are functionally inadequate today? A realistic view of the factors that can and do contribute to functional obsolescence will set a practical upper limit on design life. A LCC analysis may be useful to evaluate the economic implications of different design life assumptions.

Even after a rational decision is reached regarding capacity (size) and project design life, there is the question of available funds. Most entities, public and private, have to live within a budget. Needs generally exceed resources, so fiscal prudence will set practical limits on how much is spent today to avoid future expenses. Since it can generally be said that excessive design lives result in higher initial and total costs, then fewer projects (less capacity) can be purchased with today's limited budget.

The result of obsolescence and funding constraints is a practical limit on project design life of 50 years. This term is sufficient for most public works projects. Taxpayers can identify with receiving a benefit or service over 50 years. Design lives beyond 50 years are speculative at best.

### **Material Service Life**

Material service life is the number of years of service that can be expected from a particular type of drainage material or system before rehabilitation or replacement is necessary. The environment, effluent and application affect the service life of all materials. The NCSA in conjunction with the AISI has developed a durability guide to aid in reasonably predicting the service life of corrugated steel pipe. This guide presents comprehensive information to assist in estimating service life. Together with simple job site tests, the task of selecting the appropriate material and/or coating for a given environmental condition is made easy. Detailed information is included in Chapter 8.

Regional durability studies and the historical performance of drainage structures in local applications are also helpful in estimating material service life. A number of these are referenced in the bibliography at the end of this chapter.

In the event the estimated material service life is less than the required project design life, the possibility of rehabilitation should be considered. The end of the average service life does not necessarily mean replacement of the pipe, as is assumed in some commercially biased LCC approaches. There are a number of economical pipe rehab techniques in use. The additional years of functional service due to any repairs or rehabilitation can be considered in satisfying the project design life requirement.

## **ECONOMIC ASSUMPTIONS**

### **Discount Rate**

The discount rate represents the value of money over time. It is the interest rate at which the project owner is indifferent about paying or receiving a dollar now or at some future point in time. The discount rate is used to convert costs occurring at different times to equivalent costs at a common point in time. A discount rate that includes inflation is referred to as a *nominal* discount rate. One that excludes inflation is referred to as a *real* discount rate.

While in some public sector situations regulation or law may mandate the discount rate, *there is no single correct discount rate for all situations*. From an economic point of view, the discount rate should reflect the rate of interest that the owner could earn on alternative investment of similar risk and duration. Unfortunately, this lack of a specific or universal value can lead to confusion.

The federal government, in Office of Management and Budget Circular A-94, has established guidelines for the selection and use of discount rates. This document contains guidance for use in evaluating the LCC cost for federal projects. The January 1998 published real discount rate for use in evaluating long life projects is 7%, exclusive of inflation. This rate is based on sound economic principles, and is adequate to evaluate most public and private sector projects.

For those who only occasionally utilize LCC techniques, it can be perplexing to encounter material suppliers whose commercially motivated LCC methodology incorporate very low discount rates, some as low as 1% or less. Such claims should be put to the acid test question: Would you be satisfied if your pension investments earned a similar return? If not, the stick with the 7% recommended in OMB A-94.

### **Borrowing Rates**

Some LCC methods suggest that the interest rate on the type of public borrowing needed to finance the project should be used for the discount rate. This is completely inappropriate. It mistakes the *cost of borrowing* for the *value of money to the investor*. In the case of all public projects, the taxpayer is the “investor” or owner. While public entities may borrow funds to finance the project, the taxpayer is obliged to repay the debt incurred. The debt is merely a financing vehicle. Accordingly, the expenditure of public funds represents funds that are no longer available for use by the taxpayer. As is wisely recognized in OMB A-94, the long-term value of money to the taxpayer is 7%, exclusive of inflation. Most taxpayers would agree that this value is reasonable especially when considering long-term performance on investments.

### **Inflation**

Since LCC analysis are primarily suited to evaluate and compare all costs over the life of a project for each alternative, the question of dealing with changes in cost (inflation) over time should be considered. Predicting future costs can never be done with certainty, especially over long periods of time. Past experience with the effects of inflation is, at best, only a guide to what may occur in the future. One commonly used index of general inflation is the Producer’s Price published by the US government.

From a practical point of view, the effects of inflation can usually be ignored. This is because they are likely to affect all alternatives in a similar manner. The purpose of a LCC analysis is to determine the *relative* attractiveness of the alternatives under consideration. Therefore, the result of the evaluation (the ranking of alternates from lowest to highest cost) is generally not affected by the inclusion or exclusion of the effects of general inflation in the LCC calculations. Further, excluding inflation simplifies the calculation and reduces the chance of calculation errors influencing the results.

LCC calculations are most simply performed when all estimates of future costs are made in current dollars and are discounted to their present value using a *nominal* discount rate. This avoids the complexity inherent in attempting to accurately predict future costs. ASTM A-930 provides specific guidance on how to perform calculations using either real or nominal discount rates. For those situations where there is a requirement to recognize differential inflation, Department of the Army Technical Manual, TM 5-802-1, Economic Studies for Military-Design Applications should be consulted.

### **Residual Value**

The residual, or salvage value, of a facility and the end of the project design life theoretically should be included in a LCC analysis, as it reduces the overall cost of the alternate under consideration. In practice, it can be ignored. Typically, used drainage pipe or structures have very little value at the end of the life of the project and therefore have a negligible affect on the LCC result.



### Financial Calculations

The basic approach is to determine the present value of all estimated expenditures for each alternative under consideration. The alternate with the lowest total present value represents the most economical alternative. The present value of expenditures occurring in the future is calculated as:

$$\text{Present Value} = A \left( \frac{1}{1 + d} \right)^n$$

Where:

A = amount

d = discount rate

n = number of years from year zero to the future expenditure

Detailed calculation methodology is contained in ASTM A-930, and is part of the NCSA Least Cost Analysis computer program. Most hand held financial calculators are equipped to easily perform present value computations.

### Example

The following example develops the LCC for three alternative drainage structures to satisfy a 50-year design life.

### Alternates

- **A:** Galvanized CSP with an initial cost of \$195,000 and a projected service life of 40 years. At the end of 40 years, rehabilitation will be required to extend service life by at least 10 years.
- **B:** Asphalt coated CSP with an initial cost of \$214,500 and an estimated service life in excess of the 50-year project design life.
- **C:** Reinforced concrete pipe with an initial cost of \$230,000 and an estimated life in excess of the 50-year project design life.

### Other Assumptions

- **Maintenance:** The periodic cost for inspecting and maintaining each of the three alternates is considered to be about equal. Since the effect on all alternates is equal, these recurring costs need not be included in the calculation.
- **Rehabilitation:** The material service life of alternate A is less than the required 50-year project design life. The invert life can be extended by at least 15 years with a lining that is estimated to cost \$48,750, or 25% of the initial cost, in current dollars.
- **Discount Rate & Inflation:** All cost estimates are expressed in current dollars, inflation is ignored. The owner agrees that a real discount rate of 7% is appropriate.

**Present Value Calculation**

Of the three choices, only Alternate A needs to be analyzed to determine the present value of the invert rehabilitation projected in year 40. The present value of alternates B and C is equal to their initial cost since there are no significant future expenditures. In the case of A, at a discount rate of 7% the present value is as shown below:

Year	Current Dollars	Discount Rate = 7%	
		Factor	Present Value
0 - Initial Cost	\$195,000	1.0000	\$195,000
40 - Rehab	\$48,750	.0668	\$3,255
Total	\$243,750		\$198,255

**LCC Comparison**

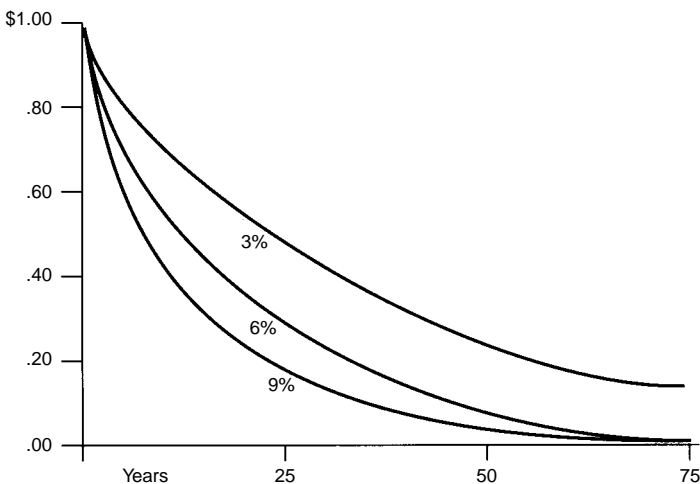
Alternate	A	B	C
Total Current Cost	\$243,750	\$214,500	\$230,000
Total Present Value @ 7%	\$198,255	\$214,500	\$230,000
Ranking	1	2	3

Alternate A, with a present value of \$198,255 is the lowest cost alternative.

**Practical Economic Considerations**

It is usually difficult to develop an accurate intuitive feeling for how the results of a LCC analysis are likely to turn out. That is due to the long project design life and the exponential nature of the present value calculation. The following table and graph clearly depict how present value is influenced over time at various discount rates.

Present Value of \$1.00 Expended at Various Intervals and Discount Rates			
Year	Discount Rate		
	3%	6%	9%
0	1.00	1.00	1.00
25	.48	.23	.12
50	.23	.05	.01
75	.11	.01	.01



Present Value of \$1.00 Expended at Various Intervals and Discount Rates

In contrast to the three-time increase in discount rates from 3% to 9%, there is a 23-times *decrease* in the significance in the present values of expenditures occurring in year 50 (.23 vs. .01). Also, since present value factors behave exponentially, a 3 percentage point difference at higher rates (9% vs.6%) has less of a present value significance than the same 3 percentage point difference at low rates (3% vs. 6%).

At realistic discount rates, the foregoing implies that variations in the exact amount or timing of future expenditures are not likely to materially affect life cycle costs, as shown in the following tables.

<b>Invert Repair Year 40 vs. 30</b>		
Expenditures Year	Invert Repair at Year	
	40	30
0	\$195,000	\$195,000
30	—	48,750
40	48,750	—
Total	\$243,750	\$243,750
Present Value @ 7%	\$198,255	\$201,404
Difference		+ 1.6%

<b>Invert Repair at 25% vs. 40%</b>		
Expenditures Year	Invert Repair as % of Original Cost	
	25%	40%
0	\$195,000	\$195,000
40	48,750	78,000
Total	\$243,750	\$273,000
Present Value @ 7%	\$198,255	\$205,247
Difference		+ 3.5%

Even with the sizeable variations in these assumptions, the effect on the total present value is less than +/- 5%. Alternate A remains the lowest cost choice.

**Spend Now-Save Later**

There can sometimes be a favorable attitude toward spending more up front in order to avoid future expenditures. Although a LCC analysis can conveniently rank alternatives, the usual format doesn't readily answer the question: Is the extra initial investment worth it? For example, the initial cost of Alternate C over Alternate A is \$35,000, but would avoid the need for future rehabilitation estimated at \$48,750 as shown below.

Cash Flow	C	A	Difference (C-A)
Year 0	\$230,000	\$195,000	\$35,000
Year 40		\$48,750	(48,750)
Total	\$230,000	\$243,750	\$(13,750)

Using differential cash flow evaluation techniques, the internal rate of return can be calculated. The internal rate of return, expressed as an interest rate, can then be used to judge the relative attractiveness of spending the higher initial investment.

The internal rate of return in this case is 0.83%, or less than 1%. This represents the discount rate, or value of money, at which the \$48,750 future expenditures avoided are equal to the \$35,000 increased initial cost. Said another way; the added investment yields less than a 1% return on investment. By any measure, a poor return.

## SUMMARY

LCC analysis is an appropriate means to aid in the selection of one design or material from various alternatives. The most critical elements of the evaluation are objective assumptions regarding project design life, material service life and the value of money or discount rate. The use of sensitivity analysis techniques is helpful in appreciating how variations in the key assumptions affect the results. The NCSA LCC analysis program is design especially for typical drainage applications, and conforms to ASTM A-930.



Long lengths and simple mechanical joints are two of the cost saving features of CSP.

---

## BIBLIOGRAPHY

- Beenhakker, Henri L., *Handbook for the Analysis of Capital Investments*, Greenwood Press, Westport, Connecticut, 1976, 452 pp.
- Childers, R. W., *Epoxy Mortar Linings for Sewers*, *Materials Protection*, March 1963.
- Economic and Environmental Principles and Guidelines for Water and Related Land Resources Implementation Studies*, U.S. Water Resources Council, Department of the Interior, Washington, D.C., February 3, 1983, 137 pp, PB 84-199405.
- Economic Studies for Military Construction Design—Applications*, Department of the Army, Washington, D.C., December 31, 1986, 60 pp, TM 5-802-1.
- Grant, Eugene L., and Ireson, W. Grant, *Principles of Engineering Economy*, 5th ed., The Roland Press Co., New York, 1970, 640 pp.
- Guidelines and Discount Rates for Benefit-Cost Analysis of Federal Programs*, Office of Management and Budget, Circular No. A-94, Washington, D.C., October 29, 1992, 26 pp.
- Jacobs, K. M., *Culvert Life Study*, Tech. Pub. 74-1, Maine D.O.T., January 1974, 24 pp.
- Leason, J. K., and Standley, R., *Least Cost Analysis*, National Corrugated Steel Pipe Association, Washington, D.C., March 1986, 8 pp.
- Life Cycle Cost Analysis of Pavements*, Transportation Research Board, National Research Council, National Cooperative Highway Research Program Synthesis of Highway Practice No. 122, Washington, D.C., December 1985, 136 pp.
- Mikesell, Raymond F., *The Rule of Discount for Evaluating Public Projects*, American Enterprise Institute, Washington, D.C., 1977, 64 pp.
- Wonsiewicz, T. J., *Life Cycle Cost Analysis Discount Rates and Inflation*, Proceedings of the International Conference on Pipeline Design and Installation, ASCE, New York, NY, Mar. 1990.
- Wonsiewicz, T. J., *Life Cycle Cost Analysis—Key Assumptions and Sensitivity of Results*, Transportation Research Board, Washington, DC, Jan. 1988.



Trunk sewer mains for storm water runoff have proven particularly suited, and economical, in design with steel. Long lengths of helical CSP cut handling and installation costs and typical field assembly of large structural plate mains, as above, clearly optimize the use of municipal tax dollars.

## CHAPTER 10 Construction

---

### CONSTRUCTION PLANS

The excavation for corrugated steel drainage structures must be made in conformance with specific project construction plans. The construction plans should contain both plan and profile views of the project area and are intended to describe graphically the horizontal and vertical locations of the conduit.

The plan view depicts horizontal location and pertinent data for the proposed conduit, as well as other items such as utilities, structures, trees, etc., that fall within the construction limits. The profile shows the elevation or vertical location of the same items as situated in the plane immediately above and below the proposed conduit.

### SUBSURFACE SOIL INFORMATION

Information regarding subsurface soil conditions is often included as a part of the construction plans. This information is used to facilitate the design of the project, and also to aid the contractor in planning his construction procedure. Often, soil information that is adequate for design does not contain sufficient detail to meet the needs of the contractor. For this reason, it may be advantageous to obtain additional subsurface information. This may be accomplished through tests performed by the contractor or by engaging the services of a soils engineer.

The purpose of a subsurface soils investigation is to determine:

- The types of soils that will be encountered in the construction area.
- The presence of rock.
- The thickness of various strata.
- The behavior of soils during and after excavation.
- The presence of ground water and the elevation of the ground water table.

Soils investigations can be performed by using several different procedures, depending upon the degree of sophistication desired.

Soil borings obtained through the use of hand or power driven augers provide continuous samples at increasing depths, but only in cohesive soils void of rock and gravel. Auger methods are also useful in determining the presence of rock strata and ground water.

More detailed analysis may be made from continuous core samples obtained by driving a hollow sampling device, such as a "split spoon." This method provides layer by layer information in relation to the surface. Soil density can also be determined by relationship to the number of blows required to drive the sampling device. Water table elevation can be measured after the water level in the bore hole is stabilized.

Soil and ground water information is graphically represented by plotting a vertical section of each sampling location on the project plan-profile or a separate profile sheet prepared to display soil information. The soil section should indicate not only the soil types and location of the ground water, but also information regarding relative density and elevations of various strata referenced to the same datum as the sewer project. A sample section of a soil log is shown in Figure 10.1.

**Figure 10.1** Log of boring no. B-21

DATE		SURFACE ELEV. 28.7		LOCATION				
DEPTH, meters	SAMPLES	SAMPLING RESISTANCE	DESCRIPTION	ELEVATION	WATER CONTENT, %	LIQUID LIMIT, %	PLASTIC LIMIT, %	OTHER TESTS
			Firm brown micaceous clayey silt (fill)					
1.5		2	Soft to very soft interbedded dark gray silty fine sandy clay/tan-brown fibrous peat		59.4	74	38	X
	P<50	1			77.6			X
3.0		P150			89.5	103	51	X
		P800		1	312.9			
			Soft to firm tan-brown silty fine sandy clay		26.5			
4.5		12	Medium to dense interbedded tan-brown silty medium to fine sand/gray-brown gravelly silty coarse to medium fine sand		24.9			M
6.0		6			16.9			
7.5		10			19.1			
9.0		16			8.2			
10.5		16			8.0			
12.0		16	Very stiff gray-red mottled fine sandy silty clay		23.9	41	23	
13.5		26			28.6			

COMPLETION DEPTH 19 m WATER DEPTH 1500 mm enc.  
SAMPLER 51 mm O.D. SPLIT BARREL SAMPLER



## TRENCH EXCAVATION

The successful completion of a conduit installation project is dependent upon all involved individuals, including the designer, field engineer, and contractor, being familiar with surface and subsurface conditions.

Prior to the start of trench excavation or any other part of the contract, both the owner and contractor should thoroughly familiarize themselves with the latest OSHA requirements relating to the work specified.

Choice of excavation equipment by the contractor is predicated on conditions existing on any specific project. Bulldozers, backhoes, draglines, scrapers, and end loaders are only part of the myriad equipment available to contractors. Each particular item of equipment is designed to perform a certain function, and the contractor must bear in mind items such as type and volume of material to be excavated, the width and depth of the trench, available working space, and the disposal of excavated material.

Regardless of the type of equipment selected to perform the work, trench excavation should proceed upstream. Most trenching equipment is more efficiently operated in this manner, and pipe sections are also easier joined when progressing in this direction. If excavated soil is to be used as backfill, it should be stockpiled in a windrow at a safe distance back from the edge of the trench.

Care should always be exercised in the operation of equipment in the vicinity of an open trench. As with the case of stockpiled excavation, the combination of equipment weight and vibration will cause a surcharge loading effect on the earth adjacent to the trench. These loads can reach such magnitudes as to cause the trench wall to fail, resulting in a cave-in.



Pre-fabricated miter section of CSP is lowered into place to match bend in trench.

The three phases of a conduit construction project (excavation, pipe installation, and backfilling) should be scheduled in close sequence with each other. An open trench is dangerous and vulnerable to accidents. In addition to safety for workmen and the general public, the contractor must always keep in mind that an open excavation can result in damage to the project under construction. The two main hazards that must always be considered in trenching work are:

- Stability of trench walls.
- Water that may accumulate in the trench resulting from seepage and surface runoff.

To minimize the chance of accidents and losses resulting from trenching operations, the following procedures should be followed:

- Begin excavation only when installation of conduit materials can immediately follow.



76 mm x 25 mm (3 x 1 in.) full bituminous coated and full paved storm sewer, 820 m (2700 ft), 2200 mm (90 in.) diameter, 1.6 mm (.064 in.).

- Protect trench walls to ensure their stability throughout the construction period.
- Follow procedures that will keep the trench free of seepage and surface waters.
- Trench excavation should proceed at the same rate as conduit installation with a minimum of distance, as dictated by safety, separating the two operations.
- As soon as practicable after conduit installation, the trench should be backfilled.

In the interest of safety, it is suggested that all excavations deeper than 1.2 m (4 ft) be equipped with ladders or steps located within 8 m (25 ft) of the working area. Ladders or steps should be secured at the top of trench walls and for ease of access, such facilities should extend at least 1 m (3 ft) above the top of the trench.

### **Trench Shape**

The cross-sectional shape of the trench is dependent upon several factors, including:

- The design depth below surface.
- The shape of the conduit structure.
- The type of soil encountered.
- Foundation material present in the bottom of the trench.
- Procedures used in placement of backfill around the conduit structure.

Corrugated steel pipe is designed structurally to withstand the formal full loading of the overburden. This means that no restriction of CSP trench width is necessary beyond those considerations listed above. Other conduit materials may require a restricted trench width as this is commonly the basis for their design be classified into two general groupings—cohesive soils and cohesionless soils. It is important to understand the difference between these two types and how stability failures occur in each.



Using steel trench shield to install CSP sewer.

Trench excavation should be carried to a depth below the corrugated pipe structure to allow for the placement of bedding materials. The depth of bedding should be 75 mm (3 in.) for ordinary soils and a minimum of 300 mm (12 in.) when rock excavation is encountered. Soft foundation materials should always be excavated to a sufficient depth to allow for the placement of granular backfill that will provide adequate support for the structure.

### Trench Stability

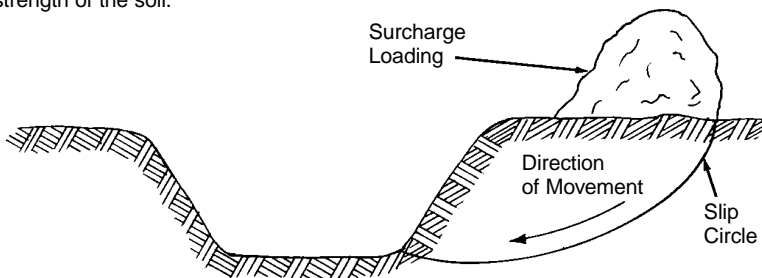
As mentioned in earlier sections, trench wall stability is of prime importance in maintaining a safe working area and providing protection to the work in progress. The stability of a trench wall is dependent upon the type of soils present and the treatment given these soils. Materials encountered in trenching operations may be classified into two general groupings—cohesive soils and cohesionless soils. It is important to understand the difference between these two types and how stability failures occur in each.

Cohesive soils are fine-grained materials, such as silts and clays, that owe the greater part of their strength to a complicated molecular interaction between individual soil particles. The stability of a cohesive soil is measured by its shearing resistance strength—the amount of force required to destroy the bonding action between the soil particles. Failure in these soils can occur along a curved surface, or “slip-circle,” as shown in Figure 10.2, and are the result of a stress “build-up,” which exceeds the shear resistance capability of such soils. The development of excessive stresses along the “slip-circle” can be attributed to several factors, including:

- The removal of lateral support through the excavation of the trench.
- The placement of a surcharge loading (soil excavation or equipment) adjacent to the trench.

Cohesionless soils are composed of coarse, weathered rock materials that depend upon an interlocking of the angular surfaces of one soil particle with another in order to maintain stability of the soil mass. Sands and gravels are typical examples of cohesionless soils. The degree of stability of this type of soil is dependent upon the soil’s internal angle of friction. While not theoretically correct, the angle of internal friction of a cohesionless soil can roughly be assumed as equal to its angle of repose the maximum angle with the horizontal at which an excavated trench wall can be expected to remain stable. Table 10.1 contains a listing of various cohesionless soils with their corresponding angle of repose and slope ratios.

An increase in soil moisture will cause a DECREASE in shearing resistance strength of the soil.



**Figure 10.2** Typical trench wall failure in cohesive soil

**Table 10.1 Stable slope angles for various cohesionless materials**

Material description	Angle of Repose	Slope ratio (horizontal to vertical)
Rock and cemented sand	90°	Vertical
Compacted angular gravels	63°	1/2:1
Compacted angular sands	34°	11/2:1
Weathered loose sands	27°	2:1

The prediction of the degree of stability for any given trench wall usually defies theoretical analysis. Investigative methods available require assumptions to be made that result in only general guidelines regarding the stability of a sloped soil surface. This is quite understandable, since most soils are not truly cohesive or cohesionless but are mixtures containing some of the properties of both general groupings.

To further complicate the situation, trenching operations can change the behavior properties of a soil as work progresses. The soil can dry out, develop cracks, and portions of the wall slough off. Rock surfaces that appear stable upon initial excavation can soften and become hazardous upon exposure to air. Consequently, all trenches should be considered as dangerous and treated with great respect.

Safety requirements dictate that all except very shallow trenches be protected by either the use of sloping trench walls or the adoption of shoring or bracing systems.

### Trench Stabilization Systems

Often, it is not practical to stabilize trench walls by the use of sloping procedures. This situation may arise due to:

- Unstable soil conditions.
- The presence of ground water.
- Nearby underground structures.
- A restricted surface work area.
- An excessively deep excavation.
- Surcharge loadings adjacent to the trench resulting from soil placement or the presence of construction equipment and/or vehicular traffic.

Systems most often used for trench stabilization, Figure 10.3, are:

- Open sheathing.
- Closed sheathing.
- Tight sheathing.
- Trench shields.

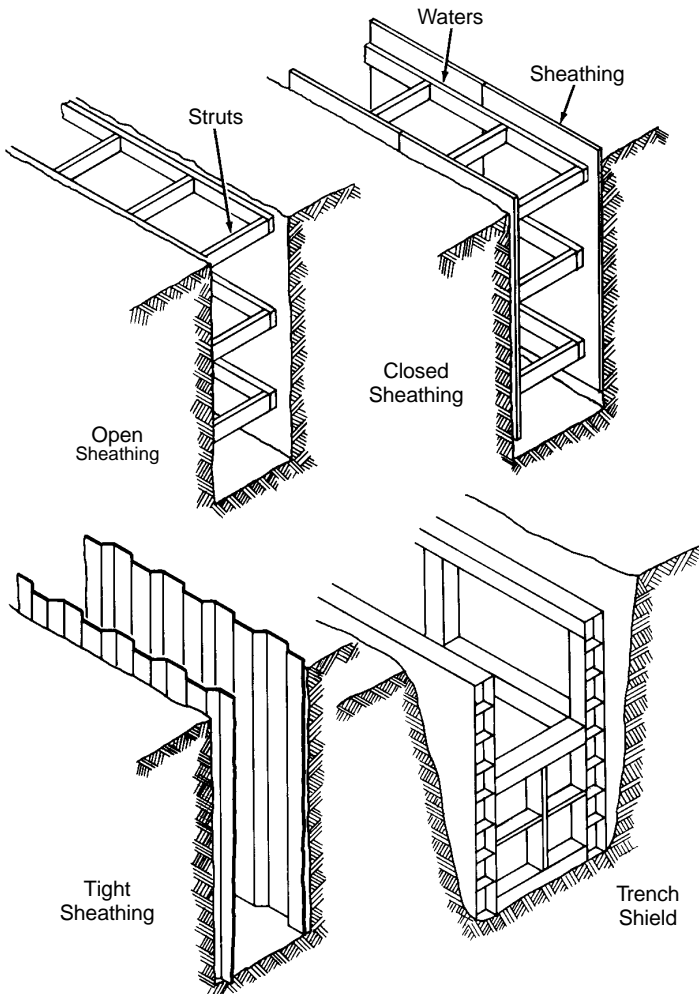
Closed and tight sheathing are similar to each other, the difference being that tight sheathing uses interlocking vertical members to impede the passage of ground water into the trench area. Either timber or steel sections can be used as the sheathing members. When working in a dry, cohesionless soil, closed sheathing may be adequate; but where ground water control operations are being conducted, tight sheathing should always be used.

In some soil conditions where a trench will be open for only a short period of time, a trench shield (also referred to as a trench box) can be utilized in lieu of a sheathing system. The shield is usually constructed of steel with reinforcing cross members at each end. OSHA regulations permit the use of a shield, provided that protection equal to other forms of shoring is achieved. The shield supplies a safe work area while trench bedding is prepared and conduit sections are placed. After

installation and backfilling around the pipe, the shield is pulled forward. Trench shields can be constructed in various widths and heights. When a trench shield is used, and as the shield is moved forward, void areas may develop between previously placed backfill and the trench wall. Therefore care must be taken to prevent problems if voids are excessive.

Backfill should be placed around the conduit while the sheathing is still in place. If wooden sheathing is removed from the trench area adjacent to the conduit, voids will develop that can reduce the effectiveness of the backfill material. For this reason, all wooden sheathing and bracing should be cut off at a point 450 mm (18 in.) above the conduit top and the supports below this point left in place.

Steel sheathing has the capability of being reused many times. For this reason, and because of the small thickness of the member, steel sheathing can be carefully removed without seriously reducing the effectiveness of the backfill material.



**Figure 10.3** Four systems most often used for trench stabilization.

Several methods are commonly used to prevent and control the intrusion of ground water into the trench area. The system selected, of course, is directly dependent upon both local conditions and the quantity of water that must be removed. Systems available include:

- Tight sheathing.
- Pumping from sumps placed in the trench base.
- Wells placed along the trench alignment.
- A system of continuous well points installed along the trench route.

In most instances, tight sheathing alone will not provide effective ground water control. If ground water levels are allowed to build up behind the sheathing, increased pressures will develop on the bracing system. This additional force is caused by two factors—the hydrostatic pressure of the collected ground water and behavioral changes that occur in the soil due to saturated conditions. For these reasons, some form of pumping operations should be carried out in conjunction with tight sheathing.

Water collection sumps can be placed in the trench bottom and filled with crushed stone or washed gravel to control relatively small amounts of ground water that may accumulate in the trench. This method of direct pumping is particularly effective in cohesionless soils or where granular bedding material has been placed in the trench bottom, thus allowing water to flow to the sump area.

When it is desired to lower the ground water table prior to trench excavation, wells or a system of continuous well points should be utilized. These methods can be used quite successfully on cohesionless soils that readily allow the passage of ground water. If individual wells placed along the proposed trench alignment will not sufficiently lower the water table, a system of well points will be required.



Installation of CSP sanitary sewers.



Full bituminous coated and full paved, 75 mm x 25 mm (3 x 1 in.) corrugation, approximately 940 m (3100 ft) of 300-1800 mm (12 - 66 in.) for storm sewer.

A well point system consists of a series of small diameter vertical pipes driven or jetted into the water-bearing strata adjacent to the proposed trench. Each pipe is equipped with a perforated well point head that allows for the passage of ground water. The well point pipes, in turn, are connected by flexible couplings to a horizontal header pipe at the ground surface. A negative pressure or suction is created in the system by use of either a vacuum or centrifugal pump that has the capability of passing both air and water.

Typical arrangements for dewatering operations are shown in Figure 10.4. The purpose of such systems is to provide a safe working area and an environment that will enable the corrugated steel structure to be installed and backfilled properly. Dewatering, however, must be conducted with care. If ground water is pumped at an excessive rate or over too prolonged a period of time, soil particles may be removed from the ground. This can result in the subsidence of trench walls and damage to nearby structures due to settlement.

## COUPLINGS

During the construction of a corrugated steel pipe system, care should be given to the treatment of joints to prevent both infiltration and exfiltration. Both processes will have an effect upon backfill materials, since soil particle migration can occur. This is particularly true when fine grained soils (silt and clay) are present in the backfill material.



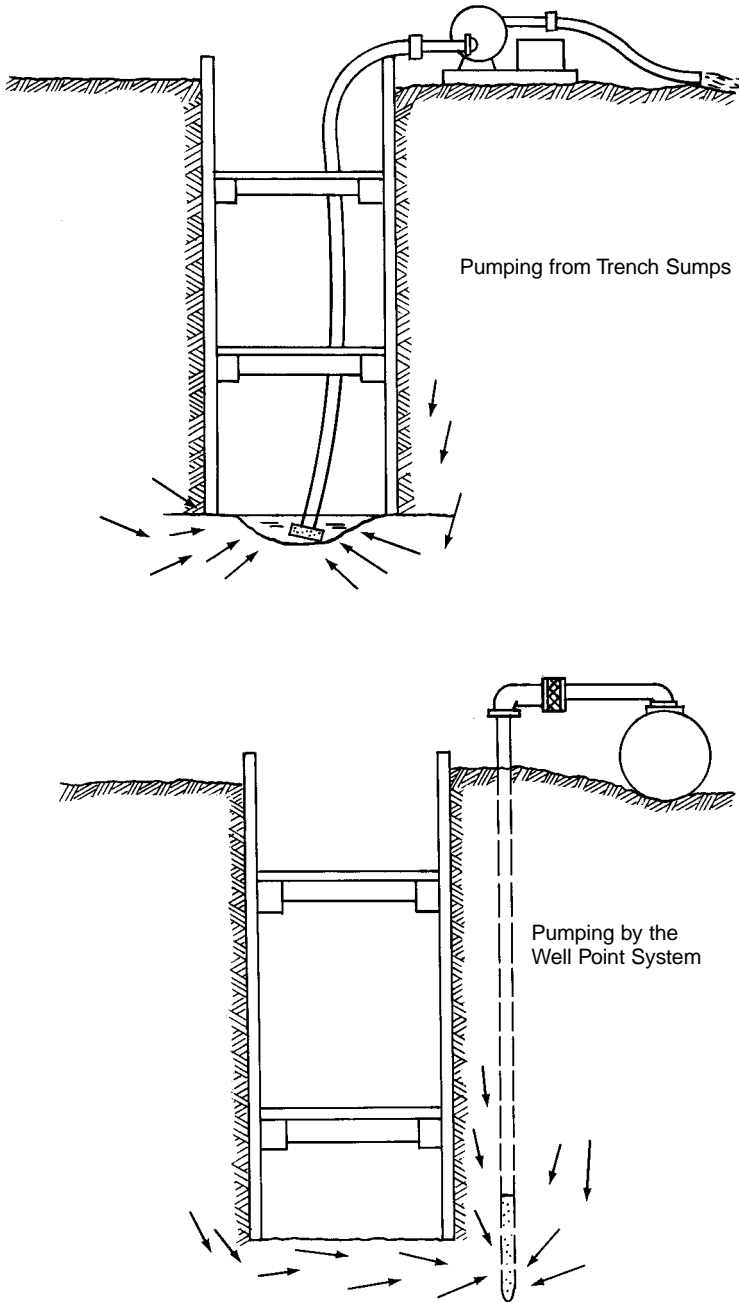


Figure 10.4 Typical arrangements for dewatering operations.

A wide variety of couplings are used for joining sections of corrugated steel pipe. To control leakage, gaskets are available for placement between the outer surface of the conduit and the connecting band.

When infiltration or exfiltration is anticipated, the owner agency may incorporate minimum pressure requirements into the project specifications.

## PERFORMANCE

Regardless of the piping material, pipe joints must provide the proper degree of tightness and provide the necessary strength to maintain this performance over the design life. Soil tightness is required for all types of buried pipe applications. A soil tight joint is necessary to ensure that water infiltrating into the pipe does not carry fine backfill material into the pipeline, reducing the necessary backfill support over time.

The proper soil tight criteria for CSP is outlined by AASHTO Section 26. This portion of the AASHTO specification is provided in Chapter 7. Joints such as the dimple or universal band that do not provide the necessary soil tightness can be made soil tight by wrapping them with an appropriate geosynthetic.

Any water tight requirements are dictated by specific job requirements. Often leakage in storm sewers, etc. is advantageous in that exfiltration losses reduce the amount of discharge while recharging the natural ground water table. Unlike sanitary sewers, CSP applications generally require specific water tight joint requirements only when the pipeline is carrying pollutants or when it is located below the ground water table so that infiltration would unduly reduce the capacity of the system.

The necessary strength requirements are also provided by AASHTO (see Chapter 7). With any pipe joint, adequate shear and moment strength levels are necessary to ensure that settlement and pipe joint cocking will not allow the joint to open. Special or higher strength joints are necessary where foundation conditions are poor or uneven. Adequate pull-apart strength also becomes a factor where settlements are expected and where pipe grades are steep.



Manhole risers can be built into the sewers with CSP pipe.

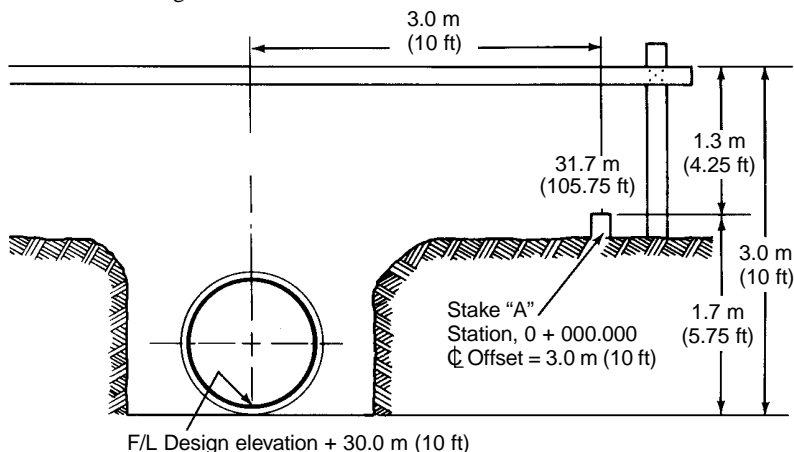
All joint requirements need to be determined in advance and properly specified. Joint designs should be prequalified by laboratory testing prior to their use to separate joint performance from contractor assembly problems.

## FIELD LAYOUT, ALIGNMENT AND INSTALLATION

Of critical importance in the process of constructing a sewer project is the correct placement of the conduit in its intended location. This is accomplished by an application of basic surveying procedures. The project is first located or “laid out” on the ground surface by the placement of a series of reference points. Next, the horizontal and vertical position of the conduit relative to the various reference points is determined. These measurements, along with the reference points, are then used by the contractor as guides for trench excavation and conduit installation.

Field layout and installation must consider both the line and grade of the project. Line refers to the horizontal location and direction of a conduit while grade is a measure of its vertical elevation and slope. Slope is usually given as a percent of grade on the construction plans and denotes the change in conduit elevation per 100 m (100 ft). Hence, a 1.5% grade simply means 1.5 m (1.5 ft) of “fall” in each 100 m (100 ft) of conduit length. Complete line and grade information should always be incorporated as a part of the construction plans.

One reliable method used to install conduit piping systems is known as the batter board or grade board system. This method consists of establishing a series of measurement points along a reference line parallel to the conduit alignment. Through the use of elementary surveying procedures, the vertical distance, or “cut,” between each reference point and the conduit flowline adjacent to the reference point is determined. With this information, a series of boards can be established at a constant distance above the proposed conduit flowline. This procedure is illustrated in Figure 10.5.



1. Layout engineer determines elevation Stake "A" is 31.7 m (105.75 ft).
2. F/L design elevation at station 0 + 000.000 is 30.0 m (100.00 ft).
3. Engineer then marks Stake "A" cut.
4. Erect "Grade Board" (Batter Board) some convenient distance above existing ground, 1.3 m (4 ft 3 in.) in this example. "Grade Board" cut is then 3.0 m (10 ft).
5. Repeat at 10 m (25 ft) stations.

**Figure 10.5** Pipe alignment using a grade board

A stringline is attached to the top of each grade board and positioned directly above the centerline of the proposed conduit. Alignment is transferred to the trench bottom by use of a plumb-bob attached to the stringline, while the conduit flowline grade is determined by a vertical measurement from the stringline.

Since the erection of boards essentially creates a measurement plane above, and parallel to, the proposed flowline, extreme care should be exercised to minimize the chance of error. The tops of any two boards, no matter how haphazardly placed, will define a plane. For this reason, a minimum of three grade boards should always be erected in series to minimize the chance of errors.

Calculations for grade board placement can be checked by visually aligning the tops to ensure that they are in a single plane.

In recent years, the board system to transfer line and grade has been supplanted by the use of laser generators. However, boards are employed on small projects and owner-agencies often require that when lasers are used, the initial alignment of the generator be through the use of a board system.

Various laser generators are available that are specifically designed for conduit installation. These generators project a concentrated low wattage light beam of such quality that little diffusion (or light spread) occurs in distances usually encountered in sewer conduit installation. The light beam essentially replaced the stringline in the transfer of line and grade. Input power is supplied by either an AC or DC source and output power is in the low range of 1 to 5 milliwatts. Care should always be exercised, however, when laser equipment is in use, since eye injuries can result from staring directly at the light source.



Quick installation of CSP sewer keeps pace with modern trenching equipment.



3000 mm (120 in.) diameter, 75 x 25 mm (3 x 1 in.) prefile full bituminous coated and full paved; 1500 m (5000 ft) installed as stream enclosure for runway extension.

Laser generating equipment is adjusted and positioned in a manner similar to surveying instruments with the exception that an adjustment is provided to incline the beam at a slope equal to the grade of the conduit. A variety of accessories are available from manufacturers, such as tripods, poles, braces, and clamps to facilitate the set-up of the laser generator. Two basic locations are generally used for the positioning of the laser equipment—in the trench bottom or on the ground surface.

When the equipment is placed in the trench, it is usually positioned in such a manner that the laser beam will describe the center of the conduit. The initial alignment of the laser generator should be accomplished by the erection of several grade boards as previously described. As each pipe section is installed, a special target or template is placed in the pipe's end and the vertical and horizontal alignment checked. The beam projected through previously-placed conduit sections is also used to provide line and grade for trench excavation and the placement of bedding materials. The light beam should be periodically checked against surface control points to ensure its correct horizontal and vertical alignment. It must also be realized that, like any light beam, a laser is subject to refraction as it passes through the atmosphere. This is primarily a function of humidity, and, for this reason, the conduit line should be ventilated as work progresses.

When a surface set-up is used, the laser generator is positioned on the conduit centerline and the light beam functions in the same manner as the stringline in a grade board system. A grade pole is then used to transfer line and grade to the trench bottom. This method has the advantage of providing a quick check against grade reference points, but the beam is not available for continuous checks in the trench.

Whenever laser equipment is used, the generator must be protected against receiving an accidental bump. A slight shift in alignment of the light beam may not be noticeable at first, but any errors will be magnified as conduit installation progresses.

## Underground Construction

When it becomes necessary to install a sewer under a city street, highway, or railroad without interrupting traffic, the following underground construction methods can be used:

- Jacking.
- Tunneling.
- Boring.

Underground construction can offer many advantages over open-cut methods, such as:

- Work can be carried out in any weather or season.
- Detours that might dangerously congest traffic may be eliminated as well as most traffic liability.
- Less pavement or other restoration is needed after the sewer is completed.

Only contractors with suitable experience and equipment should attempt underground installation.

## Alignment Changes

Changes in horizontal and vertical alignment of a corrugated steel pipe can be accomplished by any one or several of the following methods:

- Field construction manholes.
- Shop fabricated corrugated steel manholes.
- The use of special fittings such as wyes, laterals, tees, and saddle fittings for branch lines.
- Special corrugated steel pipe and pipe arch elbow sections.

Manholes are multipurpose in function. They provide access for maintenance, serve as junction chambers where several conduits are jointed together, and are used to facilitate a change in horizontal or vertical alignment. Monolithic concrete holes are usually square or rectangular in shape. Structures of this design have the distinct disadvantage of causing turbulent flow conditions that, in effect, reduce the carrying capacity in upstream portions of the conduit system.

Shop fabricated corrugated steel manholes are available for all shapes of corrugated steel pipe structures. They are designed to receive standard cast iron appurtenances such as manhole covers and grates. Corrugated steel manholes have the advantage of quick installation and backfilling, thus reducing the possibility of damage to the pipeline due to flooding caused by unexpected weather conditions.

It is frequently desirable to change the horizontal or vertical alignment of large diameter corrugated steel drainage structures without the use of a manhole or junction chamber. Shop fabricated elbow sections are available for this purpose and, in most instances, the additional fabrication cost is more than offset by the elimination of the manhole or junction chamber.

Elbow pipe sections can be prepared by manufacturers to provide gradual changes in flow direction. Such fittings are prepared from standard pipe and pipe-arch sections and have the advantage of providing a change in direction without interrupting the flowline. Figure 10.6 graphically indicates the form of these sections that are available in any increment between 0° and 90°. Elbow fittings can be used in conjunction with each other, thus providing a custom design to accommodate required field conditions. For example, a horizontal alignment change of 90° could be negotiated through the use of three 30° or four 22½° sections. A

horizontal shift in alignment can easily be accommodated by the use of two elbow fittings with the second fitting simply installed in reverse orientation to the first.

### Saddle Branches

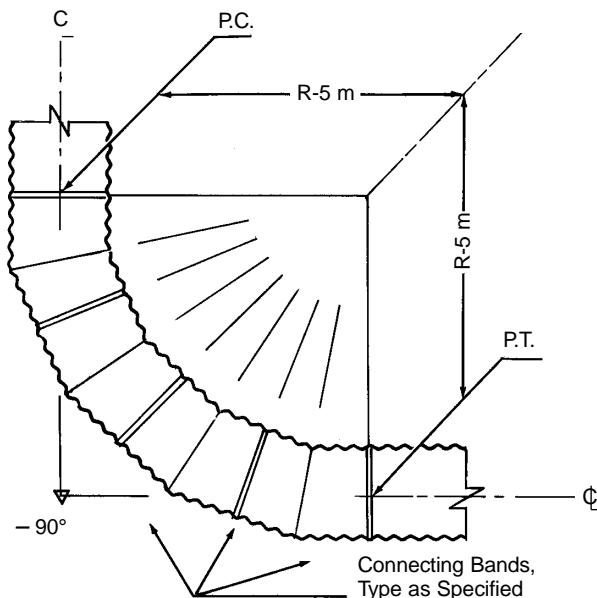
Saddle branches are fittings available for field connecting laterals and other lines entering a corrugated steel pipe structure. Any line at any angle may be joined to the main or line simply by cutting or sawing the required hole. The saddle branch is fitted over this opening and the incoming line is then attached to this fitting. See Chapter 1, page 34.

The use of special fittings and elbow sections required precise surveys both in the design and layout stages. The accurate location of special items must be predetermined in order for the manufacturer to supply fittings and straight pipe sections that will conform to field conditions. Layout and installation must be done with care to ensure proper positioning of all portions of the corrugated steel pipe system. The field layout procedure for elbow pipe sections involve geometry similar to that of a standard highway curve. It should be noted, however, that only the center points at the end of each elbow section lie on the path of the circular curve.

### BACKFILLING PROCEDURE

The performance of a corrugated steel pipe in retaining its shape and structural integrity is dependent upon the quality, placement, and degree of compaction of the backfill placed between the trench walls and the structure. The reader is encouraged to consult the following references for further detail on soils and installation requirements:

- (1) ASTM A798, "Standard Practice for Installing Factory-Made Corrugated Steel Pipe for Sewers and Other Applications."



**Figure 10.6** Alignment for Pipe Elbow Sections. The above is a design to negotiate a 90° alignment change through the use of four 22 1/2° sections.

- (2) ASTM A807, “Installing Corrugated Steel Structural Plate for Sewers and Other Applications.”

As vertical loads are applied to the conduit, the sides will tend to move outward in the horizontal direction. A properly placed backfill will resist this outward movement, creating the soil-steel interaction system upon which the design was based.

In addition to providing support to the pipe, the backfill adjacent to the pipe must also support a portion of the trench loading. Good backfill around the pipe must, therefore, be provided to ensure good results in pipe performance and to prevent damage to surface structures from trench fill substance.

Corrugated steel pipe may be placed directly on the fine-graded foundation for the pipe line. The bedding material should not contain rock retained on a 3-in ring, frozen lumps, chunks of highly plastic clay, organic matter, or other deleterious material. It is not required to shape the bedding to the pipe geometry. However, for pipe arches, it is recommended to either shape the bedding to the relatively flat bottom arc or fine-grade foundation to a slightly v-shape. This avoids the problem of trying to backfill under the difficult area beneath the invert of pipe arches. When rock excavation is encountered, it must be excavated and replaced with a layer of soil.

A properly developed foundation will:

- Maintain the conduit on a uniform grade.
- Aid in the maintenance of the desired cross-sectional shape.
- Allow for uniform distribution of loading without development of stress concentrations in the pipe wall.

Good bedding foundations can be viewed as a “cushion” for the conduit and should be relatively yielding when compared with compacted material placed between the trench wall and the pipe. In this manner, an earth arch can develop over the pipe, thus reducing the load transmitted to the conduit.



Compacting backfill is required for proper installation of all sewers.



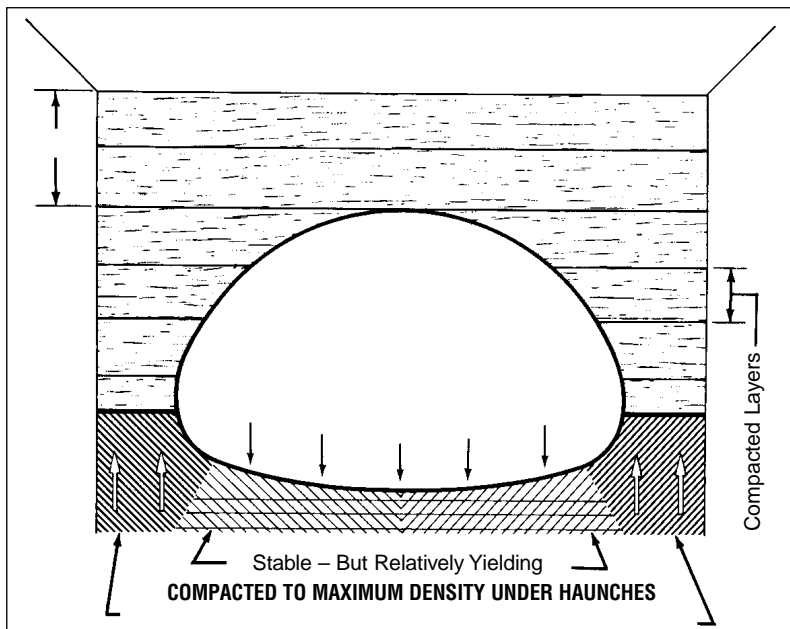
Backfill placed around the pipe structure should be granular. A small amount of silt or clay material may aid in the compaction process. Truly cohesive soils, such as heavy clays, should usually be avoided. This type of material can provide an effective backfill, but compaction must be performed at optimum moisture conditions for the particular soil.

Pit-run (or bank-run) sands and gravel compacted to 90% of AASHTO T-99 or ASTM 698 density provide excellent backfill for corrugated steel pipe. These materials exhibit good shear strength characteristics and are stable under varying moisture conditions.

To achieve the desired soil envelope around the corrugated steel pipe, the fill material should be placed in layers, uniformly from both sides, and compacted to the specified density. Care must be taken to ensure that the structure's alignment, grade, and cross-sectional shape are maintained. If excessive height differential exists between backfill from side to side, a rolling or eggshaped distortion may occur. Likewise, over-compaction can cause vertical elongation or distortion.

When backfilling around the sides of the pipe-arch, particular care should be given to those areas around the pipe-arch haunches. Maximum pressure will be exerted on the soil backfill at these points. The backfill adjacent to the pipe-arch haunches must have a bearing capacity that will allow for a safe transfer of loading between the structure and the trench walls. It is important in pipe-arch installation to ensure a favorable relative movement of the haunches with respect to the pipe bottom. For this reason, a slightly yielding foundation under the bottom, as compared to the haunches, is desirable. This factor is illustrated in Figure 10.7.

Quality backfill can be achieved by the use of a variety of tamping and vibrating equipment. Hand tamping is recommended for the filling of void areas beneath



**Figure 10.7** Pipe-arch loads are carried at the corners. Arrows show the direction of favorable relative motion of all pipe arches.



Philadelphia Airport expansion again calls for CSP storm sewers. Corrugated steel pipe was installed 25 years before in an earlier expansion.

corrugated pipe structures. To achieve proper compaction, it is often necessary to use a 2 x 4 in. timber for work in confined areas. Hand tampers can also be used to compact horizontal layers adjacent to the pipe. Hand tamping equipment should weigh at least 10 kg (20 lb) and have a surface no larger than 150 mm x 150 mm (2 x 4 in.). Mechanical tamping and vibrating equipment may also be used where space permits. However, care should be exercised to avoid damaging the pipe during the compaction process. The most important factor in the backfilling operation is the exercise of care to ensure that proper soil density is achieved between the conduit and trench walls. The greatest single error in backfilling is the dumping of piles of material into the trench and then attempting to compact the backfill without spreading. Material should be carefully placed alongside the conduit and distributed in layers prior to the compaction operation.

Waterjetting can be accomplished with a length of small diameter pipe attached to a small pump with a long length of flexible hose. Granular material placed in lifts on each side of the pipe can be worked in under haunches and consolidated. Such methods can only be used on free-draining soils, and care must be taken to avoid floatation of the pipe.

Slurry backfill can provide a viable alternative to the usual soil backfill, particularly where the native soil is not suitable or installation speed is critical. Typical specifications describe a slurry with 40 kg (100 lb) of cement per meter, 10mm ( $\frac{3}{8}$  in.) maximum size aggregate, and a 130 mm (5 in.) maximum slump, to achieve a minimum compressive strength of 690kPa (100 lb/in.<sup>2</sup>). The slurry backfill can be placed in the trench around the pipe directly from the transit mix chute without vibrating.

Care must be taken to raise the level of the slurry on either side of the pipe at about the same rate. Also, it is important to estimate and control the pipe uplift to avoid damage. Uplift can be controlled by limiting the rate of placement, and by placing weights such as sand bags, internally or externally along the pipe. Further information may be found in "CSP Structure Backfill Alternatives," NCSA, August, 1987.

**Special Note:**

Pipe construction may involve hazardous materials, operations, and equipment. This manual does not purport to address all of the safety problems associated with its use. It is the responsibility of whoever uses this manual to consult and establish appropriate safety and health practices and determine the applicability of regulatory limitations prior to use.

**SUMMARY**

Proper installation of any drainage structure will result in longer and more efficient service. This chapter is intended both to call attention to good practice and to warn against possible pitfalls. The principles discussed apply to most conditions. It is not intended to be a specification but merely a supplement to individual experience.

The following operations should be performed to insure a proper installation:

- (1) Check alignment and grade in relation to streambed.
- (2) Make sure the length of the structure is correct.
- (3) Excavate to correct width, line, and grade.
- (4) Provide a uniform, stable foundation.
- (5) Unload and handle structures carefully.
- (6) Assemble the pipe properly.
- (7) Use a suitable backfill material.
- (8) Place and compact backfill as recommended.
- (9) Protect structures from heavy, concentrated loads during construction.
- (10) Backfill subdrains with properly graded filter material.



A twin run of 1200 mm (48 in.) diameter CSP provide an underground stormwater detention system for a site.



Large diameter structures installed in difficult trench conditions using the advantage of long lengths.

# Maintenance and Rehabilitation

Most of the following information was compiled by AASHTO-AGC-ARTBA Task Force 17 on Storm Water Management.

## GENERAL

Drainage systems should be inspected on a routine basis to ensure that they are functioning properly. Inspections can be on an annual or semi-annual basis, but should always be conducted following major storms. Systems that incorporate infiltration are most critical since poor maintenance practices can soon render them inefficient. Inspection of pipes, covered trenches, and wells can be accomplished with closed circuit television; and still photographs can be obtained by either taking a picture of the monitor, or mounting a still camera alongside the T.V. camera and triggering it electronically. Other more economical alternate methods of inspection are also available. Procedures for maintenance of these systems are discussed in this chapter. It should be stressed that good records be kept on all maintenance operations to help plan future work and identify facilities requiring attention.<sup>1</sup>

## BASINS

Infiltration basin surfaces are sometimes scarified to break up silt deposits and restore topsoil porosity. This should be done when all sediment has been removed from the basin floor. However, this operation can be eliminated by the establishment of grass cover on the basin floor and slopes. Such cover helps maintain soil porosity.

Algae or bacterial growth can also inhibit infiltration. While chlorination of the runoff water can solve this problem, it is more practical to make certain that the basin is permitted to dry out between storms and during summer months. Algae and bacteria will perish during dry spells, provided that standing water is dissipated.

Holding ponds or sedimentation basins can be used to reduce maintenance in conjunction with infiltration basins by settling out suspended solids before the water is released into the infiltration basin.

Chemical flocculants can be used to speed up settlement in holding ponds. Flocculants should be added to the runoff water within the settlement pond inlet pipe or culvert where turbulence will ensure more thorough mixing. After suspended matter has flocculated and settled in the pond, the water may be released into the infiltration basin for disposal. Although chemical flocculants may be impractical for general use, they might well be considered in special cases.

Alum (Aluminum Sulfate) is readily available, inexpensive and highly effective as a flocculating agent. It is widely used in water treatment plants. Various trade name flocculation agents are also available.

Cleanout frequency of infiltration basins will depend on whether they are vegetated or non-vegetated and will be a function of their storage capacity, infiltration characteristics, volume of inflow and sediment load. Infiltration basins should be inspected at least once a year. Sedimentation basins and traps may require more frequent inspection and cleanout.

Grass surfaces in infiltration basins seldom need replacement since grass serves as a good filter material. This is particularly true of Bermuda grass, which is extremely hardy and can withstand several days of submergence. If silty water is allowed to trickle through Bermuda grass, most of the suspended material is strained out within a few meter's, of surface travel. Well established Bermuda grass on a basin floor will grow up through silt deposits, forming a porous turf and preventing the formation of an impermeable layer. Bermuda grass filtration would work well with long, narrow, shoulder-type (swales, ditches, etc.) basins where a high runoff flows down a grassy slope between the roadway and the basin. Bermuda demands very little attention besides summer irrigation in states having dry summers, and looks attractive when trimmed. Planted on basin side slopes it will also prevent erosion.

Non-vegetated basins should be scarified on an annual basis following removal of all accumulated sediments. Rotary tillers or disc harrows with light tractors are recommended for maintenance of infiltration basins where grass cover has not been established. Use of heavy equipment should be discouraged to prevent excessive compaction of surface soils. The basin floor should be left level and smooth after the tilling operation to ease future removal of sediment and minimize the amount of material to be removed during future cleaning operations. A levelling drag, towed behind the equipment on the last pass, will accomplish this.

Coarse rock or pea gravel is often placed on the bottom of a drainage basin to prevent the formation of a filter cake on the soil, by screening out suspended solids. After a period of operation the aggregate becomes partially clogged, and it is then necessary to remove and clean it, or replace it with new material. This could be done on an annual basis. Inasmuch as basins are usually accessible, this kind of operation is seldom expensive or difficult. The subsequent disposal of silt and other sediments should comply with local area codes.

## TRENCHES

The clogging mechanism of trenches is similar to that associated with other infiltration systems. Although the clogging of trenches due to silt and suspended material is more critical than that of basins, it is less critical than the clogging of vertical wells. The use of perforated pipe will minimize clogging by providing catchment for sediment without reducing overall efficiency. Maintenance methods associated with these systems are discussed later in this chapter.

## WELLS

The same clogging and chemical reactions that retard basin and trench infiltration can affect wells to an even greater extent. One problem unique to wells is chemical encrustation of the casing, with consequent blocking of the perforations or slots in the well casing. Alternate wetting and drying builds up a scale of water-soluble minerals, which can be broken up or dissolved by jetting, acid treatments or other procedures.

Some agencies restore well efficiency by periodic jetting, which removes silt and fines. Jetting consists of partially filling a well with water, then injecting compressed air through a nozzle placed near the bottom of the shaft (refer to 4. Compressed Air Jet, of this chapter). Dirt or sand that has settled in the shaft or has clogged the casing perforations is forced out the top of the well. Wells cleaned in this manner will operate fairly efficiently for several years, providing that drainage was good initially.

Clogging due to silt and suspended material is much more critical in cased wells than in basins. Filters or sedimentation basins and special maintenance procedures will help prevent silting up of wells. Underground sediment traps in the form of drop inlets are frequently used with small wells, but these inlets do little more than trap the heaviest dirt and trash, allowing finer suspended matter to flow into the well. Larger settling basins hold water longer for more efficient silt removal, and provide some temporary storage volume at the same time.

Sand and gravel or other specially selected filter materials used in “gravel packed” wells cannot be removed for cleaning if they should become clogged. Nor can well screens that become partially or totally clogged by corrosion, bacteria, or other deposits, be removed for repair. Generally, the only practical solution to the problem is to drill another well and abandon the inoperative one. Problems of clogging of gravel packing (and well walls) can often be minimized by using sediment traps and by treating the water to remove substances that will clog the soil, the gravel packing, or the well screen. Problems of corrosion of well screens can be eliminated by using slotted PVC pipes for well screens. Furthermore, the PVC is not attacked by acids or other chemicals that are sometimes used for flushing wells to remove deposits that clog the gravel packing or the walls of wells.

It is important that those maintaining infiltration facilities that employ wells be knowledgeable of the kind of materials used in screens and other parts of the systems that could be damaged by acids and other corrosive substances. The importance of regular well maintenance cannot be over stressed. Periodic cleaning and redevelopment is essential, and chlorination or other chemical treatments may be necessary if biological growth or encrustation impedes drainage. Should there be any signs of bacterial groundwater contamination, a 5-10 ppm dosage of chlorine should be added to the wells in question.

When infiltration well systems are being designed, preference should be given where practicable to the use of filter materials that would facilitate maintenance.



Exterior coatings are protected during installation by use of lifting lugs or slings.

If aggregate filter material is mounded over the infiltration well, designers should realize that it will be necessary to periodically remove the upper part of the filter material and clean it or replace it with clean material. In some situations this may not be practical. When cased, gravel-packed wells are used, it would be impractical to use a fine aggregate filter, although some designers make use of a bag constructed of filter fabric, which is fitted to the top of a well to trap sediment. When the inflow rate has decreased to the maximum tolerable amount, the bag is removed, and cleaned much as a vacuum cleaner bag is cleaned, or a new filter bag is inserted. Consideration should also be given to back flushing the well system using methods similar to those defined in earlier sections of this chapter.

### **Catch Basins**

Catch basins should be inspected after major storms and be cleaned as often as needed. Various techniques and equipment are available for maintenance of catch basins, as discussed in the next section. Filter bags can be used at street grade to reduce the frequency for cleaning catch basins and outflow lines. Filter bags have been used successfully in Canada and various parts of the United States.



Whatever the problems, fittings are available to solve them.



## METHODS AND EQUIPMENT FOR CLEANOUT OF SYSTEMS<sup>2</sup>

Various types of equipment are available commercially for maintenance of infiltration systems. The mobility of such equipment varies with the particular application and the equipment versatility. The most frequently used equipment and techniques are listed below.

### 1. Vacuum Pumps

This device is normally used to remove sediment from sumps and pipes and is generally mounted on a vehicle. It usually requires a 760 to 1200 l (200 to 300 gal) holding tank and a vacuum pump that has a 250 mm (10 in.) diameter flexible hose with a serrated metal end for breaking up caked sediment. A two-man crew can clean a catch basin in 5 to 10 minutes. This system can remove stones, bricks, leaves, litter, and sediment deposits. Normal working depth is 0 to 6 m (0 to 20 ft).

### 2. Waterjet Spray

This equipment is generally mounted on a self-contained vehicle with a high pressure pump and a 760 to 1200 l (200 to 300 gal) water supply. A 76 mm (3 in.) flexible hose line with a metal nozzle that directs jets of water out in front is used to loosen debris in pipes or trenches. The nozzle can also emit umbrella-like jets of water at a reverse angle, which propels the nozzle forward as well as blasting debris toward the catch basin. As the hose line is reeled in, the jetting action forces all debris to the catch basin where it is removed by the vacuum pump equipment. The normal length of hose is approximately 60 m (200 ft). Because of the energy supplied from the water jet, this method should not be used to clean trench walls that are subject to erosion.

### 3. Bucket Line

Bucket lines are used to remove sediment and debris from large pipes or trenches (over 1200 mm (48 in.) diameter or width). This equipment is the most commonly available type. The machine employs a gasoline engine driven winch drum, capable of holding 300 m (1000 ft) of 13 mm ( $\frac{1}{2}$  in.) wire cable. A clutch and transmission assembly permits the drum to revolve in a forward or reverse direction, or to run free. The bucket is elongated, with a clam shell type bottom that opens to allow the material to be dumped after removal.

Buckets of various sizes are available. The machines are trailer-mounted, usually with three wheels, and are moved in tandem from site to site. When a length of pipe or trench is to be cleaned, two machines are used. The machines are set up over adjacent manholes. The bucket is secured to the cables from each machine and is pulled back and forth through the section until the system is clean. Generally, the bucket travels in the direction of the flow and every time the bucket comes to the downstream manhole, it is brought to the surface and emptied.

### 4. Compressed Air Jet

The compressed air jet is normally used to clean and remove debris from vertical wells. This equipment requires a holding tank for water and the removed debris, a source of water supply (if the well is above the groundwater level), an air compressor, two 6 mm ( $\frac{1}{4}$  in.) air lines, a diffusion chamber, and a 100 mm (4 in.) diameter pipe to carry the silty water and other debris to the surface. The well should be partially filled with water, if required, and the compressed air injected through a nozzle near the bottom of the well. As the silty water enters the diffusion chamber

(to which the other air line is connected) it becomes filled with entrained air and is forced up the 100 mm (4 in.) disposal pipe and out of the top of the well by the denser water entering the bottom of the diffusion chamber intake. Normal working depths are typically 0 to 20 m (0 to 75 ft).

### **5. Surging and Pumping**

This procedure is another means of removing silt and redeveloping a well. The process involves partially filling the well with water and then pumping a snug-fitting plunger up and down within the casing. This action loosens silt and sediment lodged into the packing and the immediately adjacent soil, and pulls it into the well. Surging is immediately followed by pumping silt-laden water from the bottom of the well. If the well is situated in clay soil or if clay materials have been washed into the well, the surging and air jetting methods will be more effective if sodium polyphosphate is added to the water in the well prior to cleaning or redeveloping. A 2-5 ppm concentration of this chemical will deflocculate clay particles in the well and the immediately surrounding soil, and the clay can then be pumped or jetted out very easily. The depth is limited by the pumping capacity available.

### **6. Fire Hose Flushing**

This equipment consists of various fittings that can be placed on the end of a fire hose such as rotating nozzles, rotating cutters, etc. When this equipment is dragged through a pipe, it can be effective in removing light material from walls. Water can be supplied by either hydrant or truck.

### **7. Sewer Jet Flushers**

The machine is typically truck-mounted and consists of a large watertank of at least 3800 l (1000 gal), a triple action water pump capable of producing 7000 kPa (1000 lb/in.<sup>2</sup>) or more pressure, a gasoline motor to run the pump, a hose reel large enough for 150 m (500 ft) of 25 mm (1 in.) inside diameter high pressure hose, and



Increaser, prefabricated in CSP, reduces the overall total installed cost.

a hydraulic pump to remove the hose reel. In order to clean pipes properly, a minimum nozzle pressure of 4100 kPa is usually required. All material is flushed ahead of the nozzle by spray action. This extremely mobile machine can be used for cleaning areas with light grease problems, sand and gravel infiltration and for general cleaning.

### REPORTED PRACTICE

In 1973, a questionnaire was mailed to the maintenance engineers of 50 southern cities. Replies were received from the following cities:

ALABAMA	GEORGIA	TENNESSEE	FLORIDA
Huntsville	Atlanta	Jackson	Jacksonville
Anniston	Macon	Chattanooga	St. Petersburg
Tuscaloosa			Sarasota
Mobile			Pensacola
Florence			Bradenton

Thirteen of the fourteen used both concrete pipe and CSP for storm sewers. Periodic inspections were made in 10 of the cities to determine the need for cleaning and the useful life remaining in their storm drains. The following systems were used to clean concrete storm sewers:

- Hand and water jet 5
- Ropes, buckets, fire hose 1
- Water jet and vacuum hose 1
- Rodder with cutting edge and water 5
- Myers Machine 2

Ten of the cities used the same cleaning procedures for corrugated steel pipe. The other 4 used rodding and flushing only.

In maintaining storm sewers the following solutions to the problems shown were reported:

#### **Joint Separation**

- Grout joints 6
- Pour concrete collar 5
- Replace 2
- Hydraulic cement 1

#### **Invert Failure**

- Replace 6
- Concrete invert 8

#### **Structural Failure**

- Replace 12
- Repair 2

Four cities threaded a smaller diameter pipe within existing structures. Pressure grouting was typically used to fill the void between the new pipe and existing structure.

For sizes smaller than 800 mm (30 in.), pull-through devices for inspection and repair must be used. For high volume roads or expensive installations, a minimum size of 800 mm (30 in.) is recommended to permit access by maintenance personnel.

### REHABILITATION<sup>3</sup>

Rehabilitation of America's infrastructure is a major undertaking now being addressed by federal, state, and local governments. While the magnitude of rehabilitation may at times appear enormous, rehabilitation often is very cost effective when compared to the alternative of new construction.

Storm sewers and highway culverts represent a significant portion of the infrastructure. The American Concrete Institute (ACI) recently has addressed the problem of rehabilitating existing concrete structures of all types. Methods of rehabilitating CSP structures are outlined here. Generally, CSP structures can be rehabilitated to provide a new, complete service life at a fraction of the cost or inconvenience of replacement.

All of the methods described herein require a complete inspection and evaluation of the existing pipe to determine the best choice. With CSP, rehabilitation often requires merely providing a new wear surface in the invert. Typically, structural repair is unnecessary. However, if the pipe is structurally deficient, this does not rule out rehabilitation. Repair methods can be utilized and the structures restored to structural adequacy and then normal rehabilitation procedures performed. Even with 25% metal loss, which occurs long after first perforation, structural factors of safety are reduced by only 25%. When originally built, CSP storm sewers often provide factors of safety of 4 to 8—far in excess of that required for prudent design.

This section deals mainly with the repair of corrugated steel pipe and/or steel structural plate or the use of CSP as a sliplining material.



Concrete inverts can solve abrasion problems.

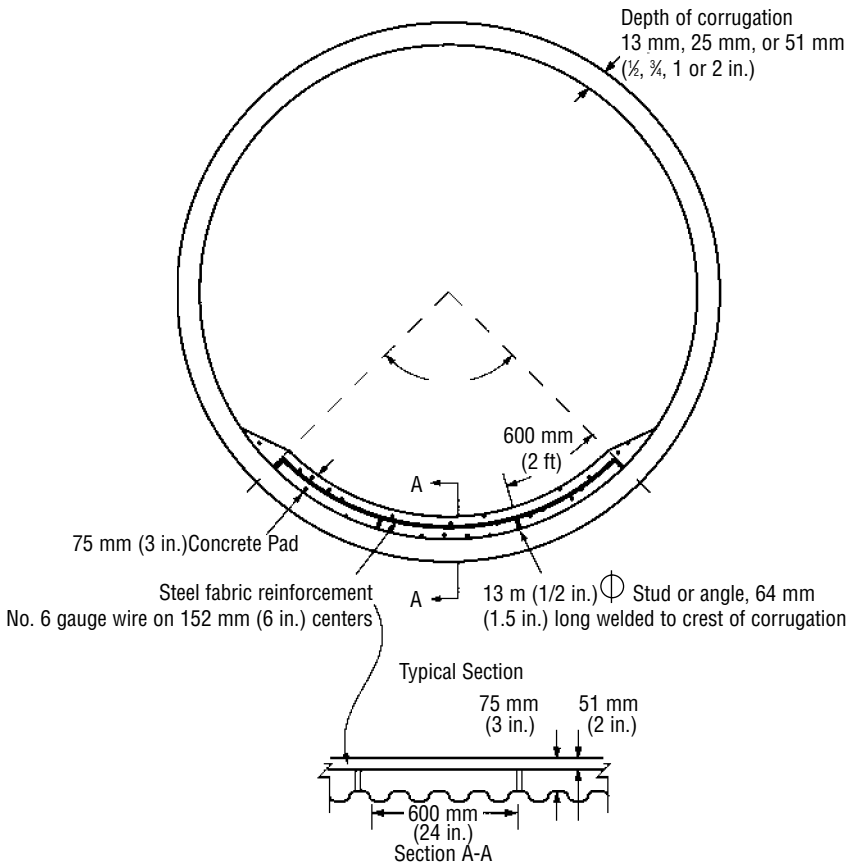
**Methods of Rehabilitation**

- In-place installation of concrete invert.
- Reline existing structure.
  - Slip line with slightly smaller diameter pipe or tunnel liner plate
    - Inversion lining
    - Shotcrete lining
    - Cement mortar lining

**In-Place Installation of Concrete Invert**

For larger diameters where it is possible for a person to enter the pipe, a concrete pad may be placed in the invert. Plain troweled concrete may be satisfactory for mild conditions of abrasion and flow. For more severe conditions, a reinforced pavement is required.

Figure 11.1 shows one method of reinforcing the pad and typical pad thickness. The final design would be in the control of the Engineer and would obviously depend upon the extent of the deterioration of the pipe.



**Figure 11.1** In-place installation of concrete invert.

### Relining Materials

The selection of the reline material is dependent upon the condition of the pipe line to be rehabilitated and the diameter and/or shape.

If the line has deteriorated to the point where it is deficient structurally, then your choice would necessarily have to be one of a material having full barrel cross section and possess sufficient structural capability to withstand the imposed dead and live loads.

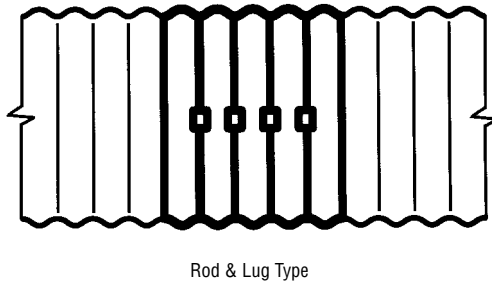
If you do not need to provide structural support, then you may direct your attention only to the repair of the invert in most cases.

The following is a discussion of reline materials and methods of installing them. It is the Engineer's responsibility to select the material and method of relining dependent upon the pipeline's rehab requirements.

### Sliplining

If downsizing of the existing line is not a concern, then the use of standard corrugated steel pipe AASHTO M-36 or ASTM760 may be used and provided in lengths that would facilitate insertion. A hydraulic advantage may be gained by using helical corrugated steel pipe or spiral rib pipe if the existing pipe is annular corrugated.

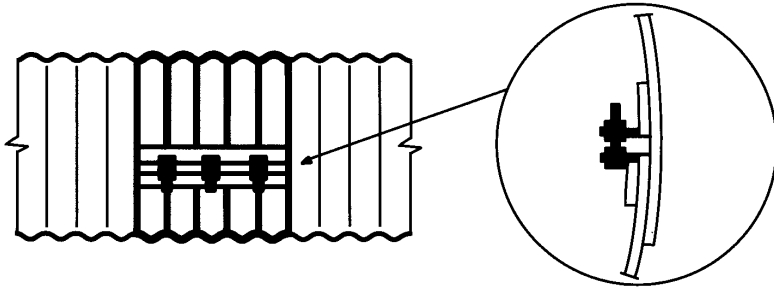
If sufficient clearance exists between the liner pipe and the existing line, the sections may be joined by the use of a silo rod and lug type coupling band. See Figure 11.2.



**Figure 11.2** Band is secured by rod around band connected by lugs.

The use of an internal expanding type coupling band is recommended to connect the sections if there is insufficient clearance on the outside of the liner pipe. See Figure 11.3.

Internal Type



**Figure 11.3** Internal expanding type coupling band.

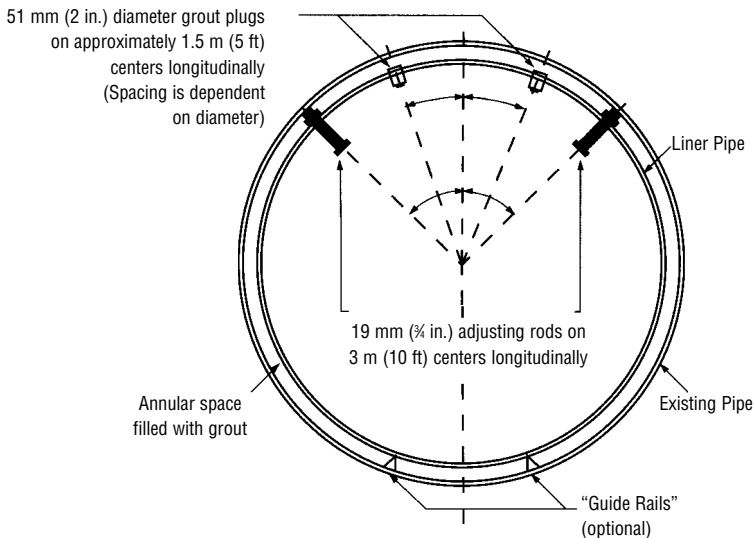
An alternative to the use of the conventional angles or lugs and bolts is to use sheet metal screws in conjunction with an installation jig.

If the owner desires to maintain maximum hydraulic capacity of the line then the use of a smooth lined corrugated steel pipe is recommended.

Choices of this type of pipe include:

1. 100% Asphalt Lined
2. 100% Cement Mortar Lined
3. Double Wall CSP
4. Spiral Rib CSP

Figure 11.4 shows a typical section of a corrugated steel pipe fabricated for sliplining.



**Figure 11.4** Typical section of corrugated steel pipe fabricated for sliplining.

### **Inversion Lining**

Inversion lining is accomplished by using needle felt or polyester fiber, which serves as the “form” for the liner.

The use of this method requires that the pipe be taken out of service during the rehabilitation period. One side of the felt is coated with the polyurethane membrane and the other is impregnated with the thermosetting resin. The felt variables include denier, density, type of material, method of manufacture (straight or cross lap), and length of fiber. The physical properties of the felt and chemicals must be determined for the specific project and in cooperation with prospective contractors.

The liner expands to fit the existing pipe geometry and therefore is applicable to egg-shaped, ovoids, and arch pipe.

Inversion lining has been utilized on lines from 100 to 2700 mm (4 to 108 in.) in diameter. It is normally applicable for distances of less than 60 m (200 ft) or where groundwater, soil condition, and existing structures make open excavation hazardous or extremely costly. Inversion lining with water is generally confined to pipelines with diameters less than 1500 mm (60 in.) and distances less than 300 m (1000 ft). Normally, air pressure is utilized for inversion techniques on larger diameter pipe. Compared with other methods, this process is highly technical. Other technical aspects include resin requirements, which vary with viscosity, felt liner, ambient temperatures, and the filler in the felt content; the effects of ultraviolet light on the resin and catalyst; and safety precautions for personnel and property.

### **Shotcrete Lining**

Shotcrete is a term used to designate pneumatically-applied cement plaster or concrete. A gun operated by compressed air is used to apply the cement mixture. The water is added to the dry materials as it passes through the nozzle of the gun. The quantity of water is controlled within certain limits by a valve at the nozzle. Low water ratios are required under ordinary conditions. The cement and aggregate are machine or hand mixed and are then passed through a sieve to remove lumps too large for the gun.

When properly made and applied, shotcrete is extremely strong, dense concrete, and resistant to weathering and chemical attack. Compared with hand placed mortar, shotcrete of equivalent aggregate-cement proportions usually is stronger because it permits placement with low water-to-cement ratios. For relining existing structures, the shotcrete should be from 50 to 100 mm (2 to 4 in.) thick depending on conditions and may not need to be steel reinforced. If used, the cross-sectional area of reinforcement should be at least 0.4% of the area of the lining in each direction.

The following specifications should be considered:

1. “Specifications for Concrete Aggregates” ASTM C 33.
2. “Specifications for Materials, Proportioning and Application of Shotcrete” ACI 506.
3. “Specifications for Chemical Admixtures for Concrete” ASTM C 494.

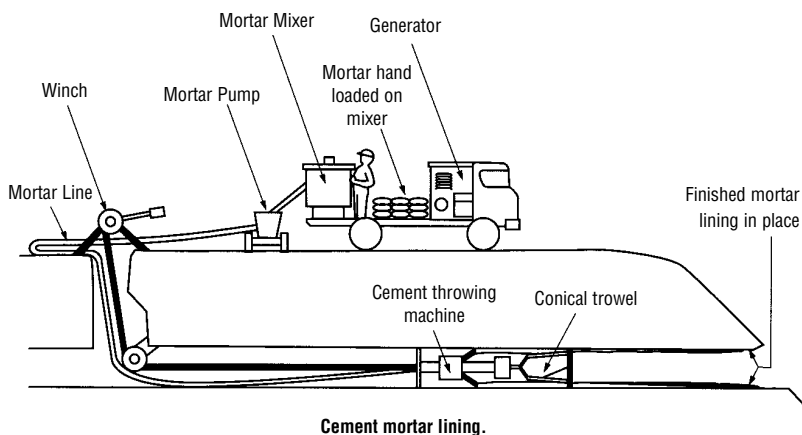
### **Cement Mortar Lining**

Cement mortar lining is particularly well suited to small diameter pipe that is not easily accessible.

The cement mortar lining is applied in such a manner as to obtain a 13 mm ( $\frac{1}{2}$  in.) minimum thickness over the top of the corrugations. Application operations



should be performed in an uninterrupted manner. The most common practice uses a centrifugal machine capable of projecting the mortar against the wall of the pipe without rebound—but with sufficient velocity to cause the mortar to be densely packed in place. See Figure 11.5, which shows a typical set-up for this process.



**Figure 11.5** Cement mortar lining.

### General

Numerous patching compounds are commercially available. Compounds such as epoxies, which are used in bridge and paving repair, can be used.

Both plain and reinforced concrete can be used. A number of the above procedures are applicable to both concrete and steel pipe. However, use of welding and mechanical fasteners for repair is applicable only to steel pipe.

Thus, the ease of maintenance associated with steel sewers is a major factor in economical sewer design.

## REFERENCES

1. Smith, T. W., Peter, R.R., Smith, R.E., Shirley, E.C., "Infiltration Drainage of Highway Surface Water," Transportation Laboratory, California Department of Transportation, Research Report M&R 632820-1, Aug. 1969.
2. *Sewer Maintenance Manual*, prepared by Municipal Engineers Association of Ontario for Ministry of the Environment, Ontario, Canada, Mar. 1974.
3. "Rehabilitation of Corrugated Steel Pipe and Pipelines of Other Materials," NCSPA Drainage Technology Bulletin, Sept. 1988.

## BIBLIOGRAPHY

*Existing Sewer Evaluation and Rehabilitation*, ASCE Manuals and Reports on Engineering Practice No. 62 WPCF Manual of Practice No. FD-6, 1983.

*Recommended Specifications for Sewer Collection System Rehabilitation*, National Association of Sewer Service Companies, 1987.



# Conversion Tables

## SI BASE UNITS

There are seven base (Table C1) and two supplementary units (Table C2) in the SI system. These are the basic units of measure for the whole system. All other SI units are formed by combining base and supplementary units through multiplication, division or a combination of both. Units formed are known as derived units.

Quantity	Name	Symbol
length	meter	m
mass	kilogram	kg
time	second	s
electric current	ampere	A
thermodynamic temperature	kelvin	K
amount of substance	mole	mol
luminous intensity	candela	cd

Quantity	Name	Symbol
plane angle	radian	rad
solid angle	steradian	sr

## DERIVED UNITS

### General

Derived units are combinations of base units. For example, the SI unit for linear velocity is the meter divided by the second, and is shown symbolically as m/s (meters per second). The oblique stroke placed between symbols indicates that the first base unit is divided by the second base unit.

A dot placed midway between base unit symbols indicates that the units are multiplied. For example, a moment of force is expressed as newton meter, and written N•m. Where brackets occur in a symbol, this indicates that the bracketed portion is to be computed first.

### Derived units with special names and symbols

Some derived units are used more frequently than others. It has been found convenient to give the most frequently used derived units their own names and symbols, to eliminate using lengthy names and symbols formed from the base units. For example, the unit for force, if expressed in terms of base units, would be “kilogram meter per second squared” ( $\text{kg}\cdot\text{m}/\text{s}^2$ ). In fact, it is called the “newton” and is expressed by the symbol “N”. There are 15 derived units with special names and symbols, and these are shown in Table C3.

**Table C3 SI derived units with special names**

Quantity	Name	Symbol	Expressed in terms of base and supplementary units
frequency	hertz	Hz	$s^{-1}$
force	newton	N	$m \cdot kg \cdot s^{-2}$
pressure, stress	pascal	Pa	$m^{-1} \cdot kg \cdot s^{-2}$
energy, work, quantity of heat	joule	J	$m^2 \cdot kg \cdot s^{-2}$
power, radiant flux	watt	W	$m^2 \cdot kg \cdot s^{-3}$
quantity of electricity, electric charge	coulomb	C	$s \cdot A$
electric potential, potential difference, electromotive force	volt	V	$m^2 \cdot kg \cdot s^{-3} \cdot A^{-1}$
electric capacitance	farad	F	$m^{-2} \cdot kg^{-1} \cdot s^4 \cdot A^2$
electric resistance	ohm	$\Omega$	$m^2 \cdot kg \cdot s^{-3} \cdot A^{-2}$
electric conductance	siemens	S	$m^{-2} \cdot kg^{-1} \cdot s^3 \cdot A^2$
magnetic flux	weber	Wb	$m^2 \cdot kg \cdot s^{-2} \cdot A^{-1}$
magnetic flux density	tesla	T	$kg \cdot s^{-2} \cdot A^{-1}$
inductance	henry	H	$m^2 \cdot kg \cdot s^{-2} \cdot A^{-2}$
luminous flux	lumen	lm	$cd \cdot sr$
illuminance	lux	lx	$m^{-2} \cdot cd \cdot sr$

### OTHER DERIVED UNITS

Derived units listed in Table 4 have names and symbols formed from base, supplementary, and derived SI units which have their own names and symbols. For example, the name and symbol for linear acceleration is formed from two base units, “meter per second squared” and is written  $m/s^2$ . The name and symbol for moment of force is formed from a derived unit and a base unit, i.e. “newton meter”, ( $N \cdot m$ ).

**Table C4** SI derived units without special names

Quantity	Description	Symbol	Description of base units
area	square meter	m <sup>2</sup>	
volume	cubic meter	m <sup>3</sup>	
speed – linear	meter per second	m/s	
speed – angular	radian per second	rad/s	indicated
acceleration – linear	meter per second squared	m/s <sup>2</sup>	by
acceleration – angular	radian per second squared	rad/s <sup>2</sup>	symbol
wave number	1 per meter	m <sup>-1</sup>	
density, mass density	kilogram per cubic meter	kg/m <sup>3</sup>	
concentration (amount of substance)	mole per cubic meter	mol/m <sup>3</sup>	
specific volume	cubic meter per kilogram	m <sup>3</sup> /kg	
luminance	candela per square meter	cd/m <sup>2</sup>	
dynamic viscosity	pascal second	Pa•s	m <sup>-1</sup> •kg•s <sup>-1</sup>
moment of force	newton meter	N•m	m <sup>2</sup> •kg•s <sup>-2</sup>
surface tension	newton per meter	N/m	kg•s <sup>-2</sup>
heat flux density, irradiance	watt per square meter	W/m <sup>2</sup>	kg•s <sup>-3</sup>
heat capacity, entropy	joule per kelvin	J/K	m <sup>2</sup> •kg•s <sup>-2</sup> •K <sup>-1</sup>
specific heat capacity, specific entropy	joule per kilogram kelvin	J/(kg•K)	m <sup>2</sup> •s <sup>-2</sup> •K <sup>-1</sup>
specific energy	joule per kilogram	J/kg	m <sup>2</sup> •s <sup>-2</sup>
thermal conductivity	watt per meter kelvin	W/(m•K)	m•kg•s <sup>-3</sup> •K <sup>-1</sup>
energy density	joule per cubic meter	J/m <sup>3</sup>	m <sup>-1</sup> •kg•s <sup>-2</sup>
electric field strength	volt per meter	V/m	m•kg•s <sup>-3</sup> •A <sup>-1</sup>
electric charge density	coulomb per cubic meter	C/m <sup>3</sup>	m <sup>-3</sup> •s•A
surface density of charge, flux density	coulomb per square meter	C/m <sup>2</sup>	m <sup>-2</sup> •s•A
permittivity	farad per meter	F/m	m <sup>-3</sup> •kg <sup>-1</sup> •s <sup>4</sup> •A <sup>2</sup>
current density	ampere per square meter	A/m <sup>2</sup>	indicated
magnetic field strength	ampere per meter	A/m	by symbol
permeability	henry per meter	H/m	m•kg•s <sup>-2</sup> •A <sup>-2</sup>
molar energy	joule per mole	J/mol	m <sup>2</sup> •kg•s <sup>-2</sup> •mol <sup>-1</sup>
molar entropy, molar heat capacity	joule per mole kelvin	J/(mol•K)	m <sup>2</sup> •kg•s <sup>-2</sup> •K <sup>-1</sup> •mol <sup>-1</sup>
radiant intensity	watt per steradian	W/sr	m <sup>2</sup> •kg•s <sup>-3</sup> •r <sup>-1</sup>

**NON-SI UNITS USED WITH THE SI**

Some non-SI Units (Table C5) are used with SI, usually for one of four reasons:–

- The unit is beyond human control, e.g. the day.
- The use of the unit is so ingrained internationally that the disruption resulting from a change would far outweigh any benefits gained. Examples of such units are minutes and hours, degrees of arc, etc.
- The unit has a very limited and well-defined use, e.g. the parsec, a unit of stellar distance.
- The unit is being retained for a limited time until a satisfactory replacement has been formulated.

**Table C5 Non-SI units**

Condition of use	Unit	Symbol	Value in SI units
Permissible universally with SI	minute	min	1 min = 60 s
	hour	h	1 h = 3600 s
	day	d	1 d = 86400 s
	degree (of arc)	°	1° = (π/180) rad
	minute (of arc)	'	1' = (π/10800) rad
	second (of arc)	"	1" = (π/648000) rad
	l	L	1 L = 1 dm <sup>3</sup>
	tonne	t	1 t = 10 <sup>3</sup> kg
Permissible in specialized fields	degree Celsius	°C	
	electronvolt	eV	1 eV = 0.160219 aj
	unit of atomic mass	u	1 u = 1.66053 x 10 <sup>-27</sup> kg
	astronomical unit	AU	1 AU = 149.600 Gm
Permissible for a limited time	parsec	pc	1 pc = 30857 Tm
	nautical mile		1 nautical mile = 1852 m
	knot	kn	1 nautical mile per hour = (1852/3600) m/s
	ångström	Å	1 Å = 0.1 nm = 10 <sup>-10</sup> m
	are	a	1 a = 10 <sup>2</sup> m <sup>2</sup>
	hectare	ha	1 ha = 10 <sup>4</sup> m <sup>2</sup>
	bar	bar	1 bar = 100 kPa
standard atmosphere	atm	1 atm = 101.325 kPa	

## MULTIPLES AND SUBMULTIPLES

In SI, a consistent method of multiplying or dividing units exists for all types of measurement. The multiplying factors are shown in Table C6. Prefixes are employed attached to the unit to indicate multiples or sub-multiples of the unit, and a corresponding symbol is attached to the unit symbol.

Example: If the original unit is a meter (m), when multiplied by 1000 it becomes a kilometer (km). When divided by 1000 it becomes a millimeter (mm). Similarly, a newton multiplied by 1000 becomes a kilonewton (kN) and, when divided by 1000 it becomes a millinewton (mN).

**Table C6 SI prefixes**

Multiplying factor	SI prefix	SI symbol
1 000 000 000 000 = 10 <sup>12</sup>	tera	T
1 000 000 000 = 10 <sup>9</sup>	giga	G
1 000 000 = 10 <sup>6</sup>	mega	M
1 000 = 10 <sup>3</sup>	kilo	k
100 = 10 <sup>2</sup>	hecto	h
10 = 10 <sup>1</sup>	deca	da
0.1 = 10 <sup>-1</sup>	deci	d
0.01 = 10 <sup>-2</sup>	centi	c
0.001 = 10 <sup>-3</sup>	milli	m
0.000 001 = 10 <sup>-6</sup>	micro	μ
0.000 000 001 = 10 <sup>-9</sup>	nano	n
0.000 000 000 001 = 10 <sup>-12</sup>	pico	p
0.000 000 000 000 001 = 10 <sup>-15</sup>	femto	f
0.000 000 000 000 000 001 = 10 <sup>-18</sup>	atto	a

Note: The SI prefixes in Table C6, as applied to linear measurement, are as shown in Table C7.

**Table C7 Metric linear measure units**

SI unit	Symbol	Equivalent in meters
terrameter	Tm	1 000 000 000 000
gigameter	Gm	1 000 000 000
megameter	Mm	1 000 000
kilometer	Km	1 000
hectometer	hm	100
decameter	dam	10
meter	m	1
decimeter	dm	0.1
centimeter	cm	0.01
millimeter	mm	0.001
micrometer	μm	0.000 001
nanometer	nm	0.000 000 001
picometer	pm	0.000 000 000 001
femtometer	fm	0.000 000 000 000 001
attometer	am	0.000 000 000 000 000 001

**ENGINEERING CONVERSION UNITS**

It is useful to have conversion units to simplify calculations when working between the U.S. traditional and SI systems. Table C8 has been specifically designed to include those units most likely to be encountered in engineering calculations relevant to this handbook.

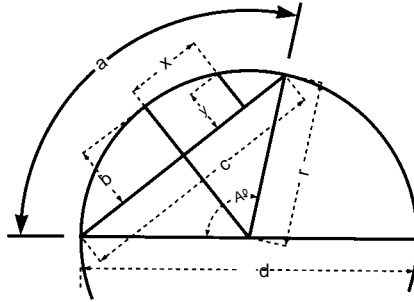
**Table C8 Engineering conversion units**

Name	SI units	U.S. Traditional units	Equivalent metric units	Factors by which values must be multiplied to convert from	
				Traditional to metric	Metric to Traditional
acceleration (gravitational)	m/s <sup>2</sup>	ft/s <sup>2</sup>	m/s <sup>2</sup>	3.084 x 10 <sup>-1</sup>	3.208 84
area	m <sup>2</sup>	in. <sup>2</sup>	mm <sup>2</sup> or	6.4516 x 10 <sup>2</sup>	1.550 00 x 10 <sup>-3</sup>
see also section properties		ft <sup>2</sup>	cm <sup>2</sup>	6.4516	1.550 00 x 10 <sup>-1</sup>
		yd <sup>2</sup>	m <sup>2</sup>	9.290 30 x 10 <sup>-2</sup>	1.076 39 x 10
		acre	ha	4.046 86 x 10 <sup>-1</sup>	2.471 05
		mile <sup>2</sup>	km <sup>2</sup>	2.589 99	3.861 02 x 10 <sup>-1</sup>
area per unit length	m <sup>2</sup> /m	in <sup>2</sup> /in.	mm <sup>2</sup> /mm	2.540 00 x 10	3.937 01 x 10 <sup>-2</sup>
		in <sup>2</sup> /ft	mm <sup>2</sup> /mm	2.116 67	4.724 41 x 10 <sup>-1</sup>
		in <sup>2</sup> /ft	mm <sup>2</sup> /m	2.116 67 x 10 <sup>3</sup>	4.724 41 x 10 <sup>-4</sup>
bearing capacity, soils	N/m <sup>2</sup>	lbf/in <sup>2</sup>	kN/m <sup>2</sup>	6.894 76	1.450 38 x 10 <sup>-1</sup>
		lbf/ft <sup>2</sup>	kN/m <sup>2</sup>	4.788 03 x 10 <sup>-2</sup>	2.088 54 x 10
		tonf/ft <sup>2</sup>	kN/m <sup>2</sup>	9.576 06 x 10	1.042 27 x 10 <sup>-2</sup>
bending moment	N-m	lbf in.	Nm	1.129 85 x 10 <sup>-1</sup>	8.850 75
		lbf ft	Nm	1.355 82	7.375 62 x 10 <sup>-1</sup>
coating thickness	m	in.	mm	2.54 x 10	3.937 01 x 10 <sup>-2</sup>
		mil or thou	mm	2.54 x 10	3.937 01 x 10 <sup>-2</sup>
coating weight	kg/m <sup>2</sup>	oz/ft <sup>2</sup>	g/m <sup>2</sup>	3.051 52 x 10 <sup>2</sup>	3.277 06 x 10 <sup>-3</sup>
corrosion rate					
mass per area unit time	g/(m <sup>2</sup> •s)	oz/(ft <sup>2</sup> •a)	g/(m <sup>2</sup> •a)	3.051 52 x 10 <sup>2</sup>	3.277 06 x 10 <sup>-3</sup>
depth per unit time	m/s	mil/a	mm/a	2.54 x 10	3.937 01 x 10 <sup>-2</sup>
density	kg/m <sup>3</sup>	g/cm <sup>3</sup>	kg/m <sup>3</sup>	1.0 x 10 <sup>3</sup>	1.0 x 10 <sup>-3</sup>
mass density		lb/in. <sup>3</sup>	kg/m <sup>3</sup>	2.767 99 x 10 <sup>4</sup>	3.612 73 x 10 <sup>-5</sup>
		lb/ft <sup>3</sup>	kg/m <sup>3</sup>	1.601 85 x 10	6.242 80 x 10 <sup>-2</sup>
		lb/gal	kg/liter	9.977 64 x 10 <sup>-2</sup>	1.002 24 x 10
density equivalent to determine force		lb/ft <sup>3</sup>	N/m <sup>3</sup>	1.570 88 x 10 <sup>2</sup>	6.365 86 x 10 <sup>-3</sup>
		lb/ft <sup>3</sup>	kN/m <sup>3</sup>	1.570 88 x 10 <sup>-1</sup>	6.365 86
flow					
volume basis	m <sup>3</sup> /s	ft <sup>3</sup> /s	m <sup>3</sup> /s	2.831 68 x 10 <sup>-2</sup>	3.531 47 x 10
		ft <sup>3</sup> /min	m <sup>3</sup> /min or	2.831 68 x 10 <sup>-2</sup>	3.531 47 x 10
			m <sup>3</sup> /h	1.699 01	5.885 78 x 10 <sup>-1</sup>
		ft <sup>3</sup> /h	m <sup>3</sup> /h	2.831 68 x 10 <sup>-2</sup>	3.531 47 x 10
		gal(Cdn)/s	liter/s	4.546 09	2.199 69 x 10 <sup>-1</sup>
		gal(Cdn)/min	liter/min	4.546 09	2.199 69 x 10 <sup>-1</sup>
		gal(Cdn)/h	liter/h	4.546 09	2.199 69 x 10 <sup>-1</sup>
		gal(US)/s	liter/s	3.785 41	2.641 72 x 10 <sup>-1</sup>
		gal/m	m <sup>3</sup> /s	7.576 80 x 10 <sup>-5</sup>	1.319 80 x 10 <sup>4</sup>
		ft <sup>3</sup> /s	L/s	2.831 68 x 10	3.531 47 x 10 <sup>-2</sup>
		gal/m	L/s	7.576 80 x 10 <sup>-2</sup>	1.319 80 x 10



**Table C8 Engineering conversion units (continued)**

Name	SI units	U.S. Traditional units	Equivalent metric units	Factors by which values must be multiplied to convert from	
				Traditional to metric	Metric to Traditional
force	N	lbf	N	4.44822	$2.248\ 09 \times 10^{-1}$
		lbf	kN	$4.448\ 22 \times 10^{-3}$	$2.248\ 09 \times 10^2$
		tonf	kN	8.896 44	$1.124\ 04 \times 10^{-1}$
		kgf	N	9.806 65	$1.019\ 72 \times 10^{-1}$
force per unit length	N/m	lbf/ft	N/m	$1.459\ 39 \times 10$	$6.852\ 18 \times 10^{-2}$
		lbf/ft	kN/m	$1.459\ 39 \times 10^{-2}$	$6.852\ 18 \times 10$
		lbf/in.	N/m	$1.751\ 27 \times 10^2$	$5.710\ 15 \times 10^{-3}$
		lbf/in.	kN/m	$1.751\ 27 \times 10^{-1}$	5.710 15
linear measurement	m	mil	mm	$2.54 \times 10$	$3.937\ 01 \times 10^{-2}$
		in.	mm	$2.54 \times 10$	$3.397\ 01 \times 10^{-2}$
		ft	mm	$3.084 \times 10^2$	$3.280\ 84 \times 10^{-3}$
		ft	m	$3.084 \times 10^{-1}$	3.280 84
		statute mi	km	1.609 35	$6.213\ 71 \times 10^{-1}$
		nautical mi	km	1.853	$5.396\ 65 \times 10^{-1}$
mass	kg	lb(avdp)	kg	$4.535\ 92 \times 10^{-1}$	2.204 62
mass per unit area	kg/m <sup>2</sup>	lb/ft <sup>2</sup>	kg/m <sup>2</sup>	4.882 43	$2.084\ 16 \times 10^{-1}$
mass per unit length	kg/m	lb/ft	kg/m	1.488 16	$6.719\ 69 \times 10^{-1}$
modulus of elasticity	Pa	lbf/in. <sup>2</sup>	MPa	$6.894\ 76 \times 10^{-3}$	$1.450\ 38 \times 10^2$
			(N/mm <sup>2</sup> )		
pressure (stress)	Pa	lbf/in. <sup>2</sup>	kPa	6.894 76	$1.450\ 38 \times 10^{-1}$
		lbf/ft <sup>2</sup>	kPa	$4.788\ 03 \times 10^{-2}$	$2.088\ 54 \times 10$
		tonf/ft <sup>2</sup>	kPa	$9.576\ 05 \times 10$	$1.044\ 27 \times 10^{-2}$
section properties:					
first moment of area,	m <sup>3</sup>	in. <sup>3</sup>	mm <sup>3</sup>	$1.638\ 71 \times 10^4$	$6.102\ 37 \times 10^{-5}$
modulus of section,					
second moment of area,	m <sup>4</sup>	in. <sup>4</sup>	mm <sup>4</sup>	$4.162\ 31 \times 10^5$	$2.402\ 51 \times 10^{-6}$
moment of inertia, I					
section properties					
per unit length:					
modulus of section	m <sup>3</sup> /m	in. <sup>3</sup> /in.	mm <sup>3</sup> /mm	$6.451\ 60 \times 10^2$	$1.55 \times 10^{-3}$
per unit length		in. <sup>3</sup> /ft	mm <sup>3</sup> /mm	$5.376\ 35 \times 10$	$1.86 \times 10^{-2}$
		in. <sup>3</sup> /ft	mm <sup>3</sup> /m	$5.376\ 35 \times 10^4$	$1.86 \times 10^{-5}$
moment of inertia	m <sup>4</sup> /m	in. <sup>4</sup> /in.	mm <sup>4</sup> /mm	$1.638\ 71 \times 10^4$	$6.102\ 37 \times 10^{-5}$
per unit length		in. <sup>4</sup> /ft	mm <sup>4</sup> /mm	$1.365\ 59 \times 10^3$	$7.322\ 85 \times 10^{-4}$
		in. <sup>4</sup> /ft	mm <sup>4</sup> /m	$1.365\ 59 \times 10^6$	$7.322\ 85 \times 10^{-7}$

**Table C9 Properties of the Circle\***Circumference of Circle of Dia 1 =  $\pi$  = 3.14159265Circumference of Circle =  $2 \pi r$ Dia of Circle = Circumference  $\times$  0.31831Diameter of Circle of equal periphery as square = side  $\times$  1.27324Side of Square of equal periphery as circle = diameter  $\times$  0.78540Diameter of Circle circumscribed about square = side  $\times$  1.41421Side of Square inscribed in Circle = diameter  $\times$  0.70711

$$\text{Arc, } a = \frac{\pi r A^\circ}{180} = 0.017453 r A^\circ$$

$$\text{Angle, } A = \frac{180^\circ a}{\pi r} = 57.29578 \frac{a}{r}$$

$$\text{Radius, } r = \frac{4 b^2 + c^2}{8 b} \quad \text{Diameter, } d = \frac{4 b^2 + c^2}{4 b}$$

$$\text{Chord, } c = 2 \sqrt{2 b r - b^2} = 2 r \sin \frac{A^\circ}{2}$$

$$\text{Rise, } b = r - 1/2 \sqrt{4 r^2 - c^2} = \frac{c}{2} \tan \frac{A^\circ}{4} = 2 r \sin^2 \frac{A}{4}$$

$$\text{Rise, } b = r + y - \sqrt{r^2 - x^2} \quad y = b - r + \sqrt{r^2 - x^2} \quad x = \sqrt{r^2 - (r + y - b)^2}$$

$$\pi = 3.14159265, \log = 0.4971499$$

$$\frac{1}{\pi} = 0.3183099, \log = 1.5028501$$

$$\pi^2 = 9.8696044, \log = 0.9942997$$

$$\frac{1}{\pi^2} = 0.1013212, \log = 1.0057003$$

$$\sqrt{\pi} = 1.7724539, \log = 0.2485749$$

$$\sqrt{\frac{1}{\pi}} = 0.5641896, \log = 1.7514251$$

$$\frac{\pi}{180} = 0.0174533, \log = 2.2418774$$

$$\frac{180}{\pi} = 57.2957795, \log = 1.7581226$$

\* From Carnegie's "Pocket Companion."

# General Tables

**Table G1 Properties of the Circle\***

Circumference of Circle of Dia 1 =  $\pi$  = 3.14159265

Circumference of Circle =  $2 \pi r$

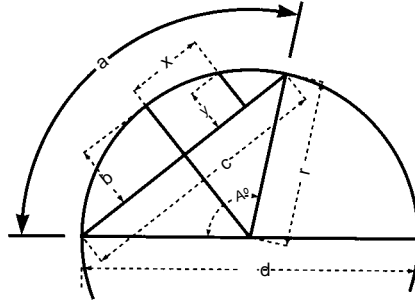
Dia of Circle = Circumference  $\times$  0.31831

Diameter of Circle of equal periphery as square = side  $\times$  1.27324

Side of Square of equal periphery as circle = diameter  $\times$  0.78540

Diameter of Circle circumscribed about square = side  $\times$  1.41421

Side of Square inscribed in Circle = diameter  $\times$  0.70711



$$\text{Arc, } a = \frac{\pi r A^\circ}{180} = 0.017453 r A^\circ$$

$$\text{Angle, } A = \frac{180^\circ a}{\pi r} = 57.29578 \frac{a}{r}$$

$$\text{Radius, } r = \frac{4 b^2 + c^2}{8 b} \quad \text{Diameter, } d = \frac{4 b^2 + c^2}{4 b}$$

$$\text{Chord, } c = 2 \sqrt{2 b r - b^2} = 2 r \sin \frac{A^\circ}{2}$$

$$\text{Rise, } b = r - 1/2 \sqrt{4 r^2 - c^2} = \frac{c}{2} \tan \frac{A^\circ}{4} = 2 r \sin^2 \frac{A}{4}$$

$$\text{Rise, } b = r + y - \sqrt{r^2 - x^2} \quad y = b - r + \sqrt{r^2 - x^2} \quad x = \sqrt{r^2 - (r + y - b)^2}$$

$$\pi = 3.14159265, \log = 0.4971499$$

$$\frac{1}{\pi} = 0.3183099, \log = 1.5028501$$

$$\pi^2 = 9.8696044, \log = 0.9942997$$

$$\frac{1}{\pi^2} = 0.1013212, \log = 1.0057003$$

$$\sqrt{\pi} = 1.7724539, \log = 0.2485749$$

$$\sqrt{\frac{1}{\pi}} = 0.5641896, \log = 1.7514251$$

$$\frac{\pi}{180} = 0.0174533, \log = 2.2418774$$

$$\frac{180}{\pi} = 57.2957795, \log = 1.7581226$$

\* From Carnegie's "Pocket Companion."

Nominal Thickness <sup>2</sup> (mm)	Minimum (mm)	Maximum (mm)	Weight (mass) <sup>3</sup> (kg/m <sup>2</sup> )
1.0	0.87	1.13	7.8
1.3	1.15	1.45	10
1.6	1.42	1.78	13
2.0	1.82	2.18	16
2.8	2.60	3.00	22
3.5	3.27	4.43	33
4.2	3.97	4.43	33

<sup>1</sup> Thickness is based on CSA G401-93

<sup>2</sup> Nominal thickness includes base metal and metallic coating

<sup>3</sup> Weight is based on nominal thickness.

Nominal Thickness <sup>2</sup> (mm)	Minimum (mm)	Maximum (mm)	Weight (mass) <sup>3</sup> (kg/m <sup>2</sup> )
3.0	2.70	3.30	24
4.0	3.70	4.30	31
5.0	4.70	5.60	39
6.0	5.70	6.60	47
7.0	6.70	7.70	55

<sup>1</sup> Thickness is based on CSA G401-93

<sup>2</sup> Nominal thickness includes base metal thickness excluding zinc coating

<sup>3</sup> Weight is based on nominal thickness.

# General Index

---

The scope of this book can best be determined by the Contents on pages *iv* through *vii*. The chapters and prime references are shown in bold face.

Tables are indicated by T followed by chapter, table number and page number (T4.18, 121). Corrections or suggestions are invited.

## A

- Abrasion level 259
- Aerial sewers 242-244
- Aircraft loads, minimum cover for  
T7.14M - T7.17, 237-241
- Alignment changes of CSP 302-303
- Allowable span T7.18M - T7.18, 243-244
- Alternate designs and bids on pipe 273-276
- Annular CSP, description 1
- Antecedent Moisture Conditions (AMC)  
73
- Arch channels 22
- Arch (pipe-) elbow fittings, minimum dimensions T1.15M - T1.15, 32-33
- Arch (pipe-) layout details T1.6M - T1.17, 12-13
- Assembly of CSP field units 246-248

## B

- Backfilling procedure 215, 303-306
- Backwater analysis in hydraulic design  
142-151
- Basins, maintenance on 309-310
- Bend losses 125
- Bernoulli equation 99-100
- Blue-green storage 194
- Bucket line for cleanout 313

## C

- Catch Basin(s) 36
  - Maintenance on 312
  - Reinforcing 38
  - Tops 37
- Channel flow, classifications of 98
- Chemical analyses 58-60
- Cleanout of systems 313-315
- Coatings 43, 256-257, 259-266

- Combination system 204-208
- Compressed air jet for cleanout 313-314
- Computer programs 92-93, 179, 182, 277
- Concrete-Lined pipe 41
- Connectors 23-26
- Construction, Chapter 10 287-307**
  - Plans in sewer excavation 287
- Contents *iv-vii*
- Conversion tables 323-330
- Corrosion
  - From soil 251-252
  - From soil vs. electrical resistivity 252
  - From water 253
- Corrosiveness of soils 252
- Corrugated Steel Pipe
  - Annular 1
  - Data 1-22
  - Helical 1
  - Sizes 2
- Cost savings in alternate design 276
- Couplings 262-264, 296-298
  - Systems 24-26
- Critical flow depth 99-103
- Curve numbers T3.5 - T3.6, 76-77

## D

- Deflection 223
- Depression storage 72-73; T3.3, 73
- Depth of cover T7.6 - T7.9, 227-228;  
T7.10M - T7.13, 230-236
- Design
  - And bids on pipe, alternate 273-275
  - Of stormwater detention facilities 189-193
- Structural, Chapter 7 217-249**
  - Techniques 203-204
- Detention facilities 185-187
- Detention pond 185-187
- Dewatering of trenches 295-296
- Dimensions
  - For CSP pipe-arch elbow fittings  
T1.15M - T1.15, 32-33
  - For CSP round fittings T1.14M - T1.14, 30-31
  - For elbows for round CSP T1.13M - T1.13, 28-29

Disclaimer *iii*

Double wall (steel lined) 42

Drain inlets, slotted 41

Drainage

From **Storms, Chapter 2 47-61**

Durability

**Chapter 8 251-269**

Coatings 256-257

Design, Example of 266

Factors affecting CSP 251-253

Field studies of 254-256

In soil 251-252

In water 253

Project design life 259

Service Life 259-266

**Durability Guidelines 259**

## E

Elbows, dimensions, minimum T1.13M - T1.13, 28-29; T1.15M -T1.15, 32-33

Energy loss

In hydraulic design 102, 147-149

Solution T5.1M - T5.1, 143-144

Entrance loss 123

Coefficient T4.15, 128

Environmental considerations 55-58

EPA regulations (proposed) T2.3, 57

Excavation of trenches 289-296

Exfiltration

Analysis 209

Calculations 209-210

## F

Field joints 24, 244, 246-248

Field layouts, alignments and installation 299-303

Field tests 201

Fire hosing flushing for cleanout 314

Fittings 27; T1.13M - T1.15, 28-33; 242

Fittings and sewer appurtenances, CSP 27

Flooding 97

Flow regulators 194 - 195

Form losses in junction, bends and other structures 122-126

Foundation drains 53-55

Collector (FDC) 54-55

Collector design sheet T5.10M - T5.10, 180-181

In a major/minor system 176

Friction losses 103-112

Equation 112-119

## G

Gaskets 24-25; T1.12, 24

General Tables 331-332

Ground water

Monitoring 61

Quality process 58-60

## H

Handling weight of CSP T1.3M - T1.4, 3-10

Helical CSP, description of 1

Highway

Live loads T7.1, 218

Loadings 217

Hydraulics

Alternative, methods for determining 152-158

Calculations T5.2M-T5.2, 146; T5.7M-T5.7, 172-173

Jump 121

Properties of conduits T4.2 - T4.4, 110; T4.5 - T4.7, 111

Of **storm sewers, Chapter 4 97-139**

Of storm inlets 127-137

Hydrograph method of stormwater detention 189-193

**Hydrology, Chapter 3 63-95**

## I

Indirect method of soil investigation and infiltration tests 203

Infiltration 51

Basins 196

Rate of, factors 200-201

Systems, maintenance on 309-312

Trench 196-198

Interior coatings

Storm sewers 256-257

## J

Joint

Properties of 247-248

Type 246

## K

Kutter equation 115

**L**

- Law of conservation 98
- Layout
  - Details for CSP pipe-arches T1.16M - T1.17, 12-13
  - Details for structural plate pipe-arches T1.19M - T1.10, 15-18
  - Details for structural plate circular pipe T1.18, 14
- Lead contamination 59-60
- Life Cycle Cost Analysis 277
  - Calculations 281-284
  - Economic Assumptions
    - Borrowing rates 280
    - Discount rate 279
    - Inflation 280
    - Residual value 280
  - Engineering Assumptions
    - Material Service Life 279
    - Project Design Life 278-279
- Linear recharge system 203
- Live loads, highway and railway T7.1M, 217
- Loadings in structural design 217-218
- Loss of head T4.12 - T4.14, 123-124

**M**

- Maintenance, Chapter 11 309 - 321**
- Major drainage system 47, 49
  - Of storm drainage facilities 159-162, 163-169
- Manhole
  - Junction losses 124-125
- Manhole(s) 36
  - Ladder 39
  - Reinforcing 38
  - Slip joints 38
  - Steps 40
  - Tops 37
- Manning Formula 112-115
- Materials
  - Description and specifications T1.16, 44
- Metal contamination 59
- Minimum cover for aircraft loads T7.14M - T7.17, 237-241
- Minor system of storm drainage facilities 47, 49, 165-169
- Moment
  - Of inertia and cross-sectional area T7.2M - T7.2, 221
  - Strength 247

**P**

- Pavings 43
- Perforated pipe 12
  - In recharge trenches 213-214
- Permeability coefficients T6.4, 201
- Pipe-arches 224
  - Elbow fittings T1.15M - T1.15, 32-33
  - Sizes and layout details T1.6M - T1.7, 12-13
- Pipe backfill 215
- Planning of urban drainage systems 49
- Point source and recharge system 204
- Pollution and runoff 50-53
- Preface *iii*
- Product usage guidelines 258
- Products, Sewer, Steel, Chapter 1 1-44**
- Profiles of pipe T1.1, 2
- Protective coatings 256-257

**R**

- Railway
  - Live loads T7.1, 218
  - Loadings 217
- Rainfall
  - Estimation 64
  - Hyetographs 65-69
  - Intensities 65, 66
  - Intensity duration frequency T5.5, 166
- Rational method, limitations of 72-73
- Recharge trenches
  - Construction of 212-215
- References
  - Durability 267-269
  - Hydraulics of storm sewers 138-139
- Hydrology 94-95
- Maintenance and rehabilitation 321
- Storm drainage planning 61
- Stormwater detention and subsurface disposal 215
- Structural design 248-249
- Value engineering and life cycle cost analysis 285
- Rehabilitation 316-321
- Reline materials 318-321
- Reported maintenance practice 315
- Resistivity values (typical) T8.1, 252
- Retention
- Wells 199
- Rooftop detention 187
- Roughness and friction formula
  - Coefficients T4.8, 112
  - Manning's formula T4.9M - T4.9, 113-114

- Round fittings, dimensions  
 Minimum T1.14M - T1.14, 30-31
- Runoff  
 Coefficients 723-73; T3.4, 74  
 Curve numbers T3.5, 76  
 Determination of hydrograph of 85-92  
 Estimation of 71-72  
 Quantity of, reduction of 50-53  
 Waters, environmental considerations 55-58
- S**
- Saddle branches 34, 303
- Sewer  
 Appurtenances 27-40  
 Design (storm) preliminary T5.6M - T5.7, 170-171  
 Installation 287-307  
 Jet flushers 314-315  
**Products, Steel, Chapter 1 1-44**
- Shapes of CSP T1.1, 2
- Shear strength 247
- Sizes of CSP T1.1, 2; T1.6M - T1.8, 12-14
- Slip joints, manhole 38
- Slotted drain inlets 41
- Soil  
 Cohesive vs. cohesionless 292-293  
 Conditions 246  
 Investigation and infiltration tests 200-203  
 Subsurface information 287-288  
 Tightness 247
- Spiral rib steel pipe 42
- Stable slope angles for various cohesionless materials T10.1, 293
- Steel Sewer Products, Chapter 1 1-44**
- Stiffness of pipes 220-222
- Storm Drainage Planning, Chapter 2 47-61**  
 Facilities, design of 159-182  
 Facilities, layout of 159
- Storm runoff, environmental considerations of 55-58
- Storm sewers  
**Hydraulic design of, Chapter 5 141-182**
- Stormwater  
 Detention facilities 185-187  
 Detention facilities, design of 189-193  
 Inlet capacities T5.7M - T5.7, 172-173  
 Management 48  
 Subsurface disposal of 196-199
- Stormwater Detention and Subsurface Disposal, Chapter 6 185-215**
- Strength considerations in structural design 219-220
- Structural Design, Chapter 7 217-249**  
 For CSP field joints 244
- Structural plate  
 Arches, representative sizes T1.11M - T1.11, 19-22  
 Pipe description 1  
 Pipe-Arches, sizes and layout details T1.9M - T1.10, 15-18  
 Subsurface soil information 287-288  
 Surface detention 185-187  
 Surface infiltration and runoff 51  
 Surface water profiles in hydraulic design 120-121  
 Surging and pumping for cleanout 314  
 Synthetic filter fabrics 215
- T**
- Testing joint tightness 298
- Thickness of pipe T1.12
- Time of concentration 79-81
- Transitions 35  
 Losses (open channel) 122  
 Losses (pressure flow) 122-123
- Trench  
 Construction in noncohesive soil or sand 212  
 Construction in permeable rock and/or stable soil 212  
 Dewatering 295-297  
 Excavation 289-296  
 Maintenance 310  
 Shape 291-292  
 Stability 292-293  
 Stabilization systems 293-296
- U**
- Underground  
 Conduits, moment of inertia and cross-section area T7.2M - T7.2, 221  
 Construction 302  
 Detention 185
- Unit hydrograph  
 Determination 85-86  
 Methods of S.C.S. 86-87  
 Rectangular 87-88



**V**

Vacuum pumps for cleanout 313

**Value Engineering and Least Cost  
Analysis, Chapter 9 271-285**

Volume reduction measures T2.1, 51

**W**

Water quality

Effects of runoff on 53

Process (ground) 58-60

Waterjet spray for cleanout 313

Watertightness 248

Waterway areas for standard sizes of CSP

T4.1M - T4.1, 108-109

Weight of CSP T1.3M - T1.4, 3-10

Wells, maintenance of 310-312

**Z**

Zero increase in stormwater runoff 48

# Notes

---

# Notes

---